



Elddis

accordo

Motor Caravan

OWNERS
HANDBOOK



Issue 1



WELCOME & INTRODUCTION	1-1	Disconnecting Mains Supply When	
End Of Life Vehicle Directive	1-1	Leaving Site	6-2
Elddis Technical Approvals	1-1	Overseas Electrical Connection	6-2
GENERAL SAFETY	2-1	Gas Supply	6-3
Please read before using your new		Connection	6-3
motorhome.	2-1	Gas Regulator	6-3
Proper And Safe Use Of Storage		High Pressure Gas Hoses	6-4
Areas In Motorhomes	2-1	Water System	6-4
Ventilation	2-2	Filling Your Fresh Water Tank	6-4
High-Level Ventilation	2-2	Waste Water Tank	6-4
Low-Level Ventilation	2-2	Draining Down Your Water System	6-4
Ventilation in Separate Bedrooms	2-2	GAS SAFETY ADVICE	7-1
Gas Dispersal Holes	2-2	Facts about LPG	7-1
Fire Safety	2-2	Awning Spaces, LPG and Appliance	
Fire Extinguishers	2-2	Exhaust	7-1
In Case Of Fire	2-2	LPG Gas System	7-1
Fire Retardant Foams	2-2	ELECTRICAL SYSTEM	8-1
Habitation Door	2-2	Battery Installation	8-1
PREPARING FOR THE ROAD	3-1	Battery Maintenance	8-1
Motorhome Weights Explained	3-1	Generators / Charger	8-1
Mass in Running Order	3-1	230v Power Supply	8-1
Maximum Technically Permissible		Mains Unit	8-1
Laden Mass	3-1	Resetting the RCD	8-2
User Payload	3-1	Automatic Charging System	8-2
Loading	3-1	Maximum Bulb Ratings for Internal Lights	8-2
Roof Racks	3-1	HOW TO USE YOUR MOTORHOMES	
Roof Loading	3-1	EQUIPMENT	9-1
Before Moving Off	3-2	Main Entrance Door Handle	9-2
Pulling Off	3-2	Control Panel	9-3
Bicycle Racks	3-2	Cooking equipment	9-4
Tow Bars	3-2	Gas Hob	9-4
MOTORWAY HANDLING	4-1	Gas Grill	9-5
Best Practice	4-1	Gas Oven	9-5
Speed Limits	4-1	Electrical Operation	9-7
Towing Your Motorhome	4-1	Gas Operation (Liquid Gas)	9-7
ARRIVING ON SITE	5-1	Setting of Cooling Compartment	
Check Site Regulations	5-1	Temperature	9-7
Selecting A Pitch	5-1	Mains power (230V)	9-8
Lateral Levelling (Side To Side)	5-1	Gas operation (Liquid gas)	9-8
Leveller Jack	5-1	Door Locking	9-9
Ramp	5-1	Whale Underfloor Space Heater	9-14
GETTING STARTED	6-1	Whale Water Heater	9-17
Electricity	6-1	Smoke Alarm	9-20
Power Supply Charger	6-1	Operation	9-20
12v Systems:	6-1	Nuisance Alarms	9-20
Generator/Charger	6-1	Maintenance	9-20
Electricity Mains Supply	6-1	Cleaning your alarm	9-20
Connecting To Mains Supply On		Carbon Monoxide Alarm	9-21
Arrival at Site	6-1	Recognising Alarm Signals and	
		Warnings	9-21



Using your Alarm	9-21	ABS - Wheel Spats & Panels	11-1
Switching on your CO Alarm	9-21	Interior Walls	11-1
Re-setting the Alarm	9-21	Furniture	11-1
Replacement of Batteries	9-21	Carpets, Upholstery And Curtains	11-1
Carbon Monoxide Alarm Procedure	9-22	Washroom And Handbasin Fittings	11-2
Maintenance of your Alarm	9-22	Shower Trays	11-2
Rooflights	9-23	Water Systems	11-2
The Heki 2 (Option)	9-23	Water Containers	11-2
To Open To The Tilted Position:	9-23	Internal Water Systems	11-2
To Open In The Intermediate Position:	9-23	Theftord Toilet	11-3
To Open In The Ventilation Position:	9-23	Changing A Wheel	11-3
Closing The Blinds:	9-23	pre-season water system preparation	11-4
Opening The Blinds:	9-23	Getting Ready for the Winter	11-5
Standard MPK Rooflight	9-23	STORAGE	12-1
Midi Heki Rooflight	9-24	Long Term & Winter Storage	12-1
The Omnivent (12v) Rooflight (Option)	9-24	Motorhome Covers	12-1
Door Flyscreen	9-24	Power Drain	12-1
Taps	9-25	MOTORHOME WARRANTY COVER ..	13-1
Kitchen Taps	9-25	Remedial Work	13-3
Internal Doors	9-26	MOTORHOME CONSTRUCTION -	
Toilet / Washroom Doors	9-26	MAIN COMPONENTS	14-1
Other Internal Doors	9-26	Solid Construction Body Shell	14-1
Magnetic Catches	9-26	Windows	14-1
Locker Door Catches (Paddle Latch)	9-26	Insulation	14-1
THETFORD C-260 CASSETTE		EQUIPMENT LIST	15-1
TOILET RANGE	9-27	Accordo	15-1
Introduction	9-27	ELECTRICAL DRAWINGS	16-1
Preparing for Use (Standard)	9-27	Accordo	16-1
Using the Toilet (Standard)	9-27	GENERAL QUESTIONS	17-1
Emptying	9-29	GLOSSARY	18-1
Emptying with Optional Features	9-29	MOTORHOME ANNUAL SERVICE	
Cleaning and Maintenance	9-30	RECORD	19-1
Toilet Bowl	9-30	NOTIFICATION OF CHANGE OF	
Waste Holding Tank	9-30	OWNERSHIP	20-1
Cleaning and Maintenance for		NOTIFICATION OF CHANGE TO	
Optional Features	9-31	NAME AND ADDRESS	21-1
Winter operation	9-31	INDEX	22-1
Storage	9-31		
Toilet unit malfunctions	9-31		
Teleco TV Aerial	9-33		
How To Make Up Your Beds	9-35		
How To Make Up Your Beds	9-36		
SECURITY	10-1		
Tracker (Option)	10-1		
Motorhome Theft	10-1		
CARE OF YOUR MOTORHOME	11-1		
Exterior Body Shell	11-1		
Glass Fibre Reinforced Plastic (GRP)	11-1		
Acrylic Windows	11-1		
Window Blinds & Flyscreens	11-1		



WELCOME & INTRODUCTION

Thank you for choosing a motorhome manufactured by Elddis.

Before you drive off, please familiarise yourself with the motorhome and read this owners' handbook. This will help you to obtain the maximum pleasure from your vehicle and avoid endangering yourself and others and the Peugeot user handbook also supplied with your motorhome.

Additional information and detailed appliance instruction manuals are also contained in your Owner's Information Pack.

Your new Elddis motorhome has been designed as a recreational vehicle and is intended for recreational use only. It is not intended for business use or for permanent habitation. Elddis accepts no liability if the motorhome is used for any purpose other than recreational/holiday use. Any use other than recreational/holiday use will invalidate your warranty.

Please note: All Elddis motorhomes are classified as Grade 3 and therefore meet with the thermal insulation and heat levels for specific climatic conditions as specified within the British and European Standard BS EN 1646 part 1.

By following the instructions provided in this handbook and maintaining your motorhome in a first class roadworthy condition, you are sure to have many years of carefree use. To ensure the very best quality and reliability all motorhome designs and new developments are rigorously tested. Therefore Elddis will accept no liability or uphold the warranty if the motorhome is altered or modified in any way.

IMPORTANT

Elddis serial number of your motorhome should be quoted in all correspondence, it can be found stamped on a plate fixed next to the Peugeot plate within the engine compartment. Your Elddis motorhome serial number can also be found on the NCC certificate that can be found within your Owner's Information Pack.

There is also a Peugeot serial number on the chassis cab door pillar, which should be quoted in any communications with Peugeot.

Changing market and supply situations may prevent us from maintaining the exact specification details in this guide and we therefore reserve the right to alter specifications as materials and conditions demand and if necessary supply an alternative.

Enjoy your new motorhome.

End Of Life Vehicle Directive

Your new motorhome fully complies with the European Directive on the End of Life Vehicles. In order to obtain information on how to dispose of your motorhome at the end of its life please visit the Peugeot website. The Peugeot website contains full details on all Peugeot products together with details of their environmental and recycling policies. The site address is www.peugeot.co.uk.

Elddis Technical Approvals

All Elddis Motorhomes have been European Commission Whole Vehicle Type approved via the Vehicle Certification Agency (VCA). In order to ensure your new motorhome is safe to use Elddis are members of and have been inspected by the following bodies.

NCC who operate a certification scheme to ensure compliance with the European safety standards for motorhomes. National Inspection Council for Electrical Installation and Contracting (NICEIC) who carry out an annual inspection of the Elddis electrical installations within motorhomes.

Gas Safe Register™ approved installers carry out an annual inspection to ensure that the gas installation installed by Elddis fully comply with all relevant regulations and standards.

Elddis is an ISO 9001:2008 approved manufacturer certified by SGS Limited.

Please note: Elddis Motorhome model year.

Elddis model year starts on the 1st September and runs to the 31st of August.



GENERAL SAFETY

Please read before using your new motorhome.

In order for you to get the most out of your new Elddis motorhome it is necessary for you to be aware of the following:

- (i) Do not obstruct ventilators (See Safety Section - Ventilation)
- (ii) Inspect the flexible gas hose regularly for deterioration and renew as necessary, with approved type, as and in any case no later than the expiry date stated on the hose.
- (iii) It is recommended that you provide a dry powder fire extinguisher complying with ISO 7165 of at least 1 KG capacity by the exit door and a fire blanket next to the cooker. Ensure you read the 'advice to occupier label' fitted to your motorhome.
- (iv) Never use portable cooking or heating equipment inside your motorhome. Do not use your fitted cooking equipment as heating at any time.
- (v) Never allow modification to your gas or electrical system unless qualified persons carry them out. A Gas Safe Register™ approved gas fitter should carry out all modification to the gas system. Any modifications carried out on the electrical system should be carried out by an electrician on the roll of the NICEIC or be a member of the ECA.
- (vi) Never exceed your motorhome's Maximum Technical Permissible Laden Mass.
- (vii) Never exceed the front or rear axle maximum load as specified by the Peugeot weight plate under the bonnet.
- (viii) Pull out worktop extensions, where fitted, are only designed to take maximum weight of 6kgs.
- (ix) Please ensure extra care when young children use high level bunks and always use the safety lift up flaps provided.
- (x) Do not leave children under 14 years of age unattended in your motorhome.
- (xi) Please ensure all gas appliances are turned off while you are travelling.

- (xii) If you suspect there is a gas leak please open all the windows then vacate the motorhome. Switch off the gas supply if it is safe to do so. Then contact your nearest Elddis Retailer to arrange for them to check the gas system.
- (xiii) Only those seats designated for travelling should be occupied when the motorhome is in motion.
- (xiv) Please note that motorhomes are covered by the seat belt regulations, which came into force in October 2006. These require children that are under 12 years old and also under 135cm in height to be seated in either child seats or on bolster cushions.
- (xv) Before travelling in your motorhome: Ensure all the tables have been stored in their designated table storage position.
- (xvi) Ensure you remove all items from the microwave before travelling.
- (xvii) It is essential that you have securely closed and locked the habitation door before setting off on any journey.

Proper And Safe Use Of Storage Areas In Motorhomes

The storage areas provided in your motorhome are designed solely for the purpose of carrying personal possessions; these areas must not be used:

- As a habitation area (e.g. living, sleeping or cooking).
- To carry passengers, animals or livestock.
- For the installation (or use) of any LPG gas operated appliances, (unless supplied fitted by the manufacturer).
- For carrying LPG gas bottle cylinders, (unless designated by the manufacturer).
- To carry any flammable liquids, (unless properly stored, sealed and secured).
- For the operation of an electrical generator.
- In such a way that the loading exceeds the payload limit, as defined by the manufacturer.
- Such that the weight distribution of the vehicle means non-compliance with the vehicle axle loads.



VENTILATION

All motorhomes manufactured by Elddis are ventilated at both high and low level in accordance with BS EN 721 Safety Ventilation. The fixed ventilation points fitted in your motorhome must not be blocked under any circumstances as your safety may depend upon them. It is advisable that the fixed ventilation points are checked and cleaned (where necessary) on a regular basis.

High-Level Ventilation

This is always provided by fixed ventilation within the fitted roof skylight. These roof skylights should be cleaned annually by use of a small brush to remove any dust that may have accumulated around the mesh fitted. On some roof skylights the mesh can be easily removed to aid cleaning. On fan-assisted roof skylights it is essential that the fan is switched off prior to cleaning.

Low-Level Ventilation

All Elddis Accordo Motorhomes have fixed low level ventilation provided. These ventilators are covered with plastic covers designed to prevent them from being obstructed by items placed within the bed box. These covers can be removed by undoing the two screws in order to facilitate cleaning the ventilators, however these covers must be replaced once cleaning is completed.

It is essential for your safety that these ventilators are not blocked at any time.

Ventilation in Separate Bedrooms

In motorhomes with separated sleeping areas, separate ventilation is required and is provided via a roof skylight at high level and a ventilator at low level within a bed box.

Gas Dispersal Holes

All appliances and gas unions have a gas dispersal hole nearby. It is essential that these are not blocked or made ineffective.

FIRE SAFETY

Fire Extinguishers

It is recommended that a 1 kg (2lb) minimum capacity dry powder fire extinguisher be carried inside your motorhome at all times. A pan fire must not have an extinguisher aimed at it, but must be smothered with a fire blanket.

In Case Of Fire

- (i) Get everyone out of the motorhome as quickly as possible using whichever exit is quickest including windows. Do not stop to collect any personal items.
- (ii) Raise the alarm. Call the fire brigade.
- (iii) Turn off gas container valve if safe to do so.

Fire Retardant Foams

All motorhomes are equipped with either Combustion Modified High Resilient (CMHR) foam cushions or sprung mattresses and fire retardant fabric. All furnishings and fabrics used by Elddis comply with the Furniture and Furnishings (Fire Safety) Regulations. In addition all upholstery is made of fire retardant fabric.

Habitation Door

Note: Please ensure you only remove the key from the door with the key in the vertical position (12 o'clock).



PREPARING FOR THE ROAD

Before venturing out on to the road with your motorhome, it is important that you prepare correctly.

MOTORHOME WEIGHTS EXPLAINED

Mass in Running Order

The weight of your motorhome as it leaves the factory, as new with standard fixtures and fittings, plus an allowance for the driver of 75kgs, the mass of the fuel when the tank is full and an allowance of 10kgs per gas bottle, the number of gas bottles equal to the number of connections provided at the regulator.

Maximum Technically Permissible Laden Mass

The maximum mass the vehicle can be when fully laden for use on the road.

User Payload

The load margin (payload), this represents the difference between the Mass in Running Order and the Maximum Technically Permissible Laden Mass. It shows the maximum weight that can be loaded into your motorhome, covering items such as food, crockery, cutlery, clothing, bedding, etc.

Loading

It should be noted that even weight distribution is a major factor in making your motorhome an easy and pleasant vehicle to drive. Care should therefore be taken in balancing the load, ensuring that heavy items are well spaced and are in as low a position as possible, for example, low cupboards and bed boxes.

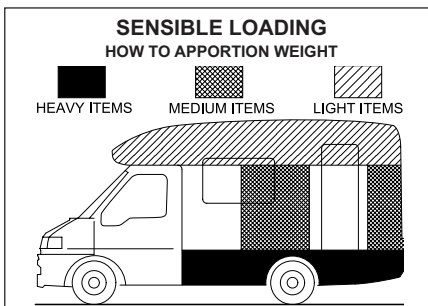

Note: Light items are considered as clothing and bedding. It is not recommended to travel with tinned items in overhead lockers.

IMPORTANT: Do not exceed maximum technical permissible laden mass for your motorhome.

Roof Racks

Some models of motorhomes have, available as an option, a roof rack and ladder. Care is needed when using this facility. We recommend you exercise extreme caution when loading and unloading.

CAUTION: Do not allow anyone to climb onto the roof. Do not exceed the stated maximum load. Items fitted other than standard equipment will deplete the payload stated in this handbook.

Roof Loading

All motorhomes have a specially designed roof rack system fitted or available as an optional extra. The roof of each motorhome is strengthened to accommodate the roof rack.

Please note: The roof rack is capable of withstanding a maximum weight of 12 stone/ 76kgs. Static roof loading or top box loading should be limited to a maximum of 76kgs including contents, or the limit set by the top box manufacturer, whichever is the lower figure.

WARNING: Under NO circumstances walk on the roof section

Before venturing out on to the road with your motorhome, it is important that you prepare correctly.

Roof loads should be evenly distributed and securely fastened, but care must be taken not to overtighten straps or ropes to the point where roof rails or brackets may become distorted, particularly as during braking and cornering, forces exerted by straps or ropes are greatly increased.

It is also worth noting that when carrying heavy or large objects on the roof, the vehicles handling may change due to the resultant displacement of the centre of gravity and the increased area exposed to the wind.



BEFORE MOVING OFF

Whenever making a journey with your motorhome, either setting off on holiday or returning home, it is good practice to run through this simple checklist.

- (i) Close and secure all cupboards and drawers and secure any loose articles.
- (ii) Do not store tins, bottles, etc. in overhead lockers.
- (iii) **Close and secure all windows and roof lights.**
- (iv) Leave all curtains and blinds open to aid visibility.
- (v) Check that gas cylinders are securely fastened and that the valve on the gas cylinder is turned off. Also ensure that the gas locker door is securely locked.
- (vi) Turn off all gas appliances.
- (vii) Switch off 240volt supply at source; disconnect mains cable and store in an appropriate place.
- (viii) Check that the battery is secure and that the battery box door is locked.
- (ix) Ensure the fridge is on 12V operation and door lock is set. (Note: the electrical relays will allow the fridge to be run on the vehicle battery when the engine is running.)
- (x) Remove any external fresh water connections etc.
- (xi) Make sure any heavy articles are stored in accordance with the loading procedure.
- (xii) Lock the motorhome habitation door (remember to take out your keys).
- (xiii) Check your external rear view mirrors and adjust if necessary.
- (xiv) If a step is used, ensure it is put away before moving off.
- (xv) Your new Elddis motorhome has been designed to carry passengers in designated passenger seats only. The fitting of a 3-point seat belt can identify these seats. Any seat not fitted with a 3point seat belt is not designated as a passenger seat.

- (xvi) You are strongly recommended not to carry passengers unless they are seated in a designated passenger seat.
- (xvii) Ensure all tables have been stored in their designated table storage position.
- (xviii) Ensure you remove all items from the microwave (if fitted) before towing.
- (xix) Check all the road lights are operational.

Pulling Off

- Pull away smoothly.
- Avoid wear and tear on clutch and transmission by taking extra care.
- Change gears smoothly.
- Try not to jerk the clutch.

Bicycle Racks

Fitting a bicycle rack to the rear panel of a motorhome will affect how weight is distributed. There are restraints to be aware of with such fitments.

The maximum loading allowed on the back panel is 75 kgs including the weight of the bike rack and bicycles.

The motorhome must also be balanced to take into account the new weight distribution. Weight must be distributed evenly.

Elddis cannot be held responsible for problems related to a bicycle rack fitted by a third party. A copy of the rear panel drawing must be obtained by the retailer or service centre from Elddis to ensure correct fixing points are located.

Tow Bars

Your new Elddis motorhome has been designed to accept a Witter tow bar. This has been approved via type approval to ensure it is safe to use and is the only tow bar approved for fitting to Elddis motorhomes. The maximum load allowed on the tow ball is 100kgs and the maximum overhang is specified by the tow bar when fitted. The fitting points for the tow bar are designated by the fixing hole in the Witter extensions fitted to the Peugeot chassis and full details are available upon request from Elddis.



MOTORWAY HANDLING

Best Practice

To gain the most enjoyment and ensure a long life for your motorhome, the following should be observed:

- Do not bump kerbs with wheels.
- When overtaking ensure sufficient clearance is given to other vehicles.
- Your Motorhome will not accelerate as quickly as a car, so take this into account when attempting to overtake other vehicles.
- Carry out all manoeuvres as smoothly as possible.
- Use the wing mirror to check your motorhome has cleared the other vehicle.
- Slow down and take care when driving over raised speed bumps, 'sleeping policemen' or when embarking/ disembarking ferries.
- In high or cross winds, travelling downhill or in conditions of poor visibility reduce your speed.
- High-sided vehicles can cause air buffeting so extra care must be taken when passing or being passed. Leave as much space as possible when overtaking these types of vehicles

Speed Limits

Be sure to observe all statutory speed limits and adapt your speed to take account of prevailing weather and road conditions.

Towing Your Motorhome

In the unlikely event that you have to tow your motorhome, the towing point is fitted within the front bumper, behind the removable flap provided by Peugeot. The towing hook can be found in the tool box supplied by Peugeot, found under the front passenger seat.



ARRIVING ON SITE

CHECK SITE REGULATIONS

On arrival at a campsite, you should always check the site regulations. This will help avoid any unnecessary conflict with site management and other site users.

SELECTING A PITCH

Carefully select where you wish to place your motorhome. The site should be as level as possible, preferably not under or near trees, well drained and away from possible boggy areas. Consider how you will move the motorhome when it is time to leave the site. On sloping ground it is better to pitch facing downhill, especially during wet weather.

LATERAL LEVELLING (SIDE TO SIDE)

A quick glance at your pitch should tell you if you are likely to need side to side levelling i.e. levelling across the axle. On uneven ground lateral levelling is accomplished by the use of a leveler jack or ramp and a spirit level placed 'across' the motorhome floor.

LEVELLER JACK

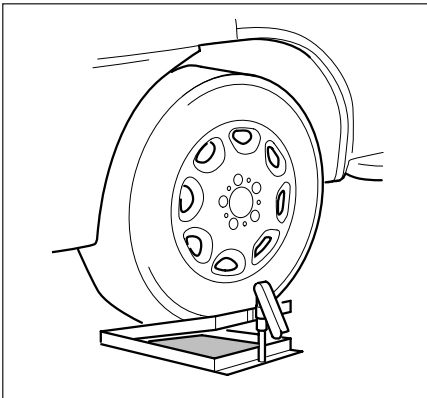

Place the leveler jack, folded flat, in front of the wheel that is to be raised to level the axle. Drive the motorhome onto the leveler jack and adjust the height until the spirit level shows that the motorhome is laterally level.

RAMP

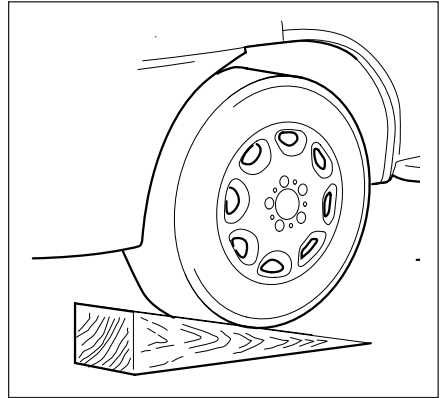

Reverse onto your pitch about a foot further back than you wish to end up. Then place the levelling ramp in front of the wheel that needs to be raised.

Place a spirit level parallel to the axle or just inside the motorhome door. It helps to have two people at this point. One should drive the motorhome very slowly forward moving the wheel up the ramp and the other should indicate when the spirit level bubble is in the middle.

Whichever method you use, once level, apply the motorhome handbrake and chock the motorhome wheel if necessary.



GETTING STARTED

You have arrived at your destination and now want to start to enjoy your new Elddis motorhome. The following is a step by step guide to connecting your services and getting everything in your motorhome working.

ELECTRICITY

Power Supply Charger

Your motorhome is fitted with a power supply/charger. This will charge the motorhome leisure battery when fitted and also power the 12V systems in your motorhome.

It is recommended that you always carry a leisure battery.

The Charger is fully automatic and will not overcharge the leisure battery.

Elddis recommends that you fit a good leisure battery rated at least 85 amp hours.

12v Systems:

When connected to the 230V site supply the automatic Power Supply/Charger will charge the vehicle battery and power the 12V systems.

When the ignition is switched on the 12V system in the motorhome is automatically switched off, vehicle power is supplied to the refrigerator and battery charging is in operation.

GENERATOR/CHARGER

When connecting to a generator, always switch off the RCD, start the generator and allow running for a few minutes to stabilise. When this has happened, switch the RCD to the ON position.

ELECTRICITY MAINS SUPPLY

Your motorhome's main electrical installation is designed to run on 230V at 50 hertz AC supply.

CONNECTING TO MAINS SUPPLY ON ARRIVAL AT SITE

Before connecting the motorhome installation to the mains supply, check that:

- (i) The mains supply is suitable for your installation and appliances, i.e. whether

it is AC or DC and whether it is at the correct voltage and frequency.

- (ii) Your motorhome is properly earthed. Never accept a supply from a socket outlet or plug having only two pins, or from a lighting outlet.
- (iii) Any residual current device (earth leakage circuit breaker) in the mains supply to the motorhome has been tested within the last month. In case of doubt, consult the site owner or their agent.
- (iv) Make sure that the switch at the site supply point is off and that all electrical equipment in the motorhome is switched off by ensuring your motorhome mains isolating switch on the MCB is in the 'OFF' position.

Once the above checks have been made:

- (v) Remove any cover to the electricity inlet provided on the motorhome and insert the female connector of the flexible orange supply cable as shown.

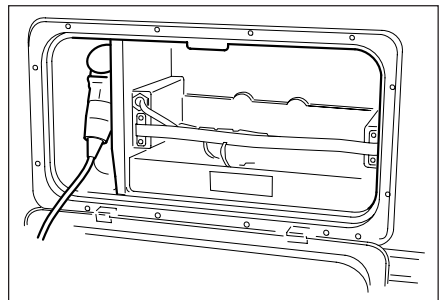

- (vi) Locate the site supply and remove any cover from the socket outlet provided at the supply point. Insert the male plug at the other end of the flexible orange supply cable. Switch on the main switch at the site supply point (if appropriate).
- (vii) Place any surplus cable under the motorhome. Ensure that the surplus cable is not coiled up as it could overheat.
- (viii) The MCB main electricity supply switch should be put in the 'ON' position.
- (ix) Check the RCD is working by pressing



WIRING OF CONNECTING CABLE AND MOTORHOME MAINS INLET

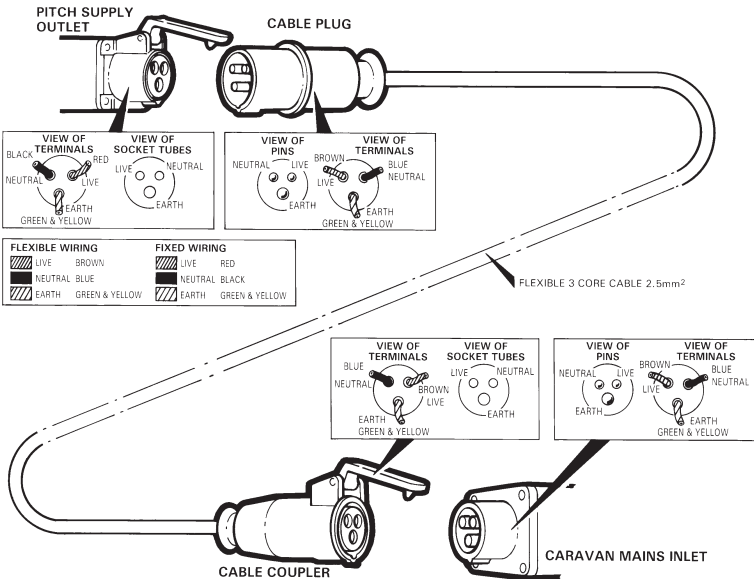

WARNING: It is essential that connections are made exactly as shown. If terminal markings are not in accordance with the above diagram they must be ignored.

the test button. Once pressed all electrical lights and appliances should cease to operate. Reset and then check the electrical system is operational.

- (x) Finally in order to get your 12V system operational, ensure the master 12V switch is in the 'ON' position.

DISCONNECTING MAINS SUPPLY WHEN LEAVING SITE

- (i) Switch 'OFF' at the motorhome mains isolating switch.
- (ii) Remove the male plug from the site supply.
- (iii) Disconnect the female plug from the motorhome and store the cable in an appropriate locker.

OVERSEAS ELECTRICAL CONNECTION

Please note: Connection to a mains voltage supply OVERSEAS requires particular attention.

Care must be taken when connecting supplies abroad since the supplies can be of REVERSE POLARITY.

The significance of REVERSE POLARITY is that when equipment is switched off, it may not be electrically isolated. The only certain way of making equipment safe is to unplug it.

A means of checking the polarity of the mains supply when overseas is recommended. There are available several proprietary makes of equipment for the purpose.

If it can be achieved, it is preferable to connect live to live and neutral to neutral to maintain full electrical protection.

CHECK all motorhome equipment is set-up to accept the site supply before actually switching on.



GAS SUPPLY





Your motorhome is designed to operate using either propane or butane liquefied petroleum gas at 30M/bar. Gas can be obtained from your motorhome dealer. Your motorhome is designed to accept a maximum 2 x 6kg Calor Lite propane cylinders available from motorhome dealers and Calor gas retailers. For further information please visit www.calorlite.co.uk.

Connection

Make sure that heating and cooking appliances and gas cylinders are switched off.

Each gas appliance is connected to its own gas isolation tap under the cooker. These are identified on the tap via a label. Below is a key to identify each label.

To operate the tap the arrow on the tap shows the direction of flow for the gas. The arrow should be pointing towards the appliance for the appliance to operate. There will be a small label next to the bank of taps under the cooker, which is also reproduced below:

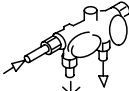
 Water Heater	 Cooking Appliance
 Space Heater	 Hob
 Refrigerator	 Gas On/Off

Gas Regulator

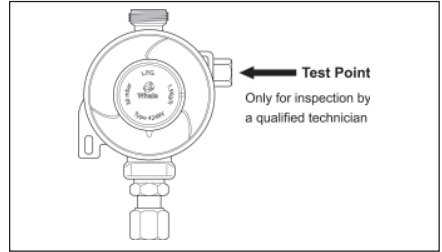

Your Accordo Motorhome has been installed with a Whale gas regulator which is designed to supply both Butane and Propane gas at a pressure of 30mbar.

It is not designed to be used while the vehicle is in motion.

Pressure regulating devices and hoses must be replaced with new ones no more than 10 years after their date of manufacture (every 8 years if used commercially). This is the responsibility of the owner.



High Pressure Gas Hoses

You should only connect to this regulator using a length of approved high-pressure hose not exceeding 450mm from the gas cylinder to the regulator. These approved high-pressure hoses are available from your Elddis Retailer. These hoses are connected using screw thread fittings, which will make a seal if connected and tightened using a spanner. Once the hose is securely connected turn on the gas tap above the regulator, then turn on the gas bottle to allow gas to flow into the motorhome.

In order to make all your motorhome gas appliances operational it is necessary to open each appliance gas tap as detailed in previous column. All your gas appliances should now be operational. Instructions on how to use each appliance are detailed later in your handbook.

WARNING: Aerosols and highly flammable liquids must not be stored in the compartment behind, or adjacent to, any gas appliance. Some industrial LPG appliances operate at high pressure and require a 'high pressure' regulator. This often has an adjusting handle on it. NEVER use such a regulator on a motorhome.

Ventilation holes must be clear at all times.

WATER SYSTEM

Filling your fresh water tank

Your Elddis motorhome is fitted with a standard water inlet which can be filled using a hose pipe connected to a tap placed into the water filler point.

Please take care not to over fill your tank it is advised that someone monitors the water level in the tank while filling is in progress.

Waste Water Tank

Your new Elddis motorhome is also fitted with a 70Litre waste water tank. All waste water excluding the toilet waste will run into the waste water tank. The level of water in the tank can be monitored using the control panel. Opening the grey waste outlet provided on the outside of the motorhome empties the tank. Open the tap when the outlet is over a drain and the water will run out of the tank.

Draining Down Your Water System

- (i) It is essential that you drain down your motorhome water system when it is not in use. This is most important during winter months to protect against frost damage
- (ii) Disconnect the water pump and switch off power supply.
- (iii) Open the safety drain valve on the water heater located next to the water heater.
- (iv) Open all taps and remove all plugs from sinks and showers. Lever operated taps should have the lever put into the up and central position.
- (v) Open both the blue and grey drain outlets on the outside of your motorhome.
- (vi) Adjust the level of the motorhome to ensure that the drain outlet is at the lowest point of the motorhome.



GAS SAFETY ADVICE

In the event of a suspected gas leak the gas must be turned off using the isolation valve on the gas bottle. A competent gas fitter should then check the system before it is used/reused.

Regularly check flexible gas hose, joints and connections for tightness. Finally, make sure that each gas appliance is working efficiently to the recommendations of the appliance manufacturers.

See Index - Ventilation

FACTS ABOUT LPG

- LPG is not poisonous.
- Bi-products are harmless.
- LPG is dangerous if all air and oxygen is excluded.
- LPG has been given a smell by the manufacturers in order to identify leaks.
- The gas is heavier than air and therefore sinks to the lowest point.

AWNING SPACES, LPG AND APPLIANCE EXHAUST

There is no danger of pollution of an enclosed awning space from the LPG exhaust from a refrigerator venting into it. Space heaters may produce sufficient exhaust to pollute the awning space, if it is totally enclosed, from a general comfort, smell and hygiene point of view. In extreme cases there could be a build up of carbon dioxide to a dangerous level. Motorhome owners are advised to allow some fresh air circulation in the awning space when such appliances are in use.

Please note: Ventilation holes must be clear at all times.

LPG GAS SYSTEM

Elddis does not recommend the use of any external cylinders. All cylinders in use should be within the gas locker provided. If you wish to utilise a larger cylinder and have this outside the gas locker then the connecting hose must not exceed 750mm.

It is recommended that no flammable material is stored or placed within 300mm of any open flame. You are advised not to use any additional gas appliances outside your motorhome.

Please ensure that you have read the operating instructions for each gas appliance contained in your Owners Information Pack. Please ensure that any gas hose left unconnected is protected from dirt or other foreign bodies entering the hose.



ELECTRICAL SYSTEM 12V POWER SUPPLY

Battery Installation

Your motorhome will be fitted with a charging and power distribution unit.

If you wish to install a leisure battery please ensure that it is placed on the battery tray supplied with your motorhome. Then place the tray in the battery locker fitted to the side of your motorhome. Connect the battery to the clamp fittings connected to the connection leads within the battery box.

Elddis recommends that you use sealed for life leisure batteries of a minimum rating off 85 ampere-hours at 20 hours discharge rate.

Battery Maintenance

Winter Storage

During winter storage, please ensure that the leisure battery is fully charged. Dependent on the battery's capacity and age, it will require recharging at regular intervals.

You must check the charge of your battery and recharge if necessary on a regular basis. This will depend on your leisure battery's capacity, age and state of charge. Charge at regular intervals.

Points to remember

- Prolonged discharge causes harmful sulfation and may damage a battery.
- Discharged (dead) batteries are prone to freezing in cold temperatures.
- For peak performance never let a battery sit discharged for long periods of time.
- Over discharged batteries are permanently damaged and need to be replaced.

Note: Do not over discharge the battery. One of the most common causes of battery failure is when the battery is discharged below the recommended level of approximately 12.2v - ref table. Discharging a battery below this figure will cause permanent damage. Overheating and gassing will occur when re-connected to the mains supply.

	12 Volt Battery	State of Charge
Good	12.7V	100%
	12.5V	90%
OK	12.42V	80%
	12.32V	70%
	12.20V	60%
	12.06V	50%
Warning	11.9V	40%
	11.75V	30%
	11.58V	20%
Damaged	11.31V	10%
	10.5V	0%

Good: the battery is in good condition and not in need of charging

OK: nothing to worry about but put the battery on charge as soon as you can

Warning: get the battery on charge as soon as you can. Leave it and the battery will be damaged, possibly beyond repair

Damaged: Replace battery

Generators / Charger

All electrical equipment fitted in your new motorhome can be run from either a controlled generator or charger whose output is maintained between 11volts and 14volts.

At least once every 3 years, the motorhome electrical installation should be inspected and tested and a report on its condition obtained, as prescribed in British Standard BS7671.

230v POWER SUPPLY

Mains Unit

The Mains Unit replaces the conventional fuse box. Similar, but larger ones are often fitted in new houses. The unit, normally located in the wardrobe, gives overloads and earth leakage protection for the 230V electrical supply in your motorhome.

For normal operation all switches on the unit need to be in the ON position. The switches on the left of the unit are known as MCB's (miniature circuit breakers). These take the place of the conventional fuse but are more convenient. In the event of a fault the MCB 'trips' i.e. automatically moves to the OFF position. After elimination of the fault the



MCB can be re-set by switching to the ON position (against the spring pressure in an upwards direction). If an earth fault develops, or a person was to touch a live piece of equipment, the leakage of current to earth should immediately operate the RCD (residual current device) and 'trip' the main switch, to the OFF position. This switch can only be re-set after elimination of the fault.

Please note: In case of difficulty, consult an approved electrical installation contractor (who may be the local electricity board). It is dangerous to attempt modifications and additions yourself.

CAUTION: Lamp holder-plugs (bayonet- cap adaptors) should not be used under any circumstances.

Resetting the RCD

To re-set, operate the switch as for MCB's. Periodically, the RCD should be checked by operating the test button marked 'T'. The unit should immediately switch to the OFF position. If the unit does not switch off then a qualified electrician should be consulted. If the unit does switch off, the test is complete and the switch can be re-set restoring the supply back to normal.

Please note: Simultaneous operation of all of the 230V mains electrical equipment may not be possible. A typical UK site mains hook-up point provides a maximum output of 16 amps and on some continental sites the available output may be as low as 5 amps. If your loading exceeds the site supply it may trip the site circuit breaker. Please check the available mains output with your site operator. The following items need to be added together if used simultaneously.

230V mains equipment typical consumption figures:

- Refrigerator 0.50 amps
- Charger 0.50 amps
- Water heater 3.9 amps
- Blown air heaters 8.5 amps
- Colour TV 3.33 amps

AUTOMATIC CHARGING SYSTEM

The battery charger will operate automatically when the motorhome is connected to the mains outlet on a motorhome site. The 12V system, with the exception of the 12V refrigerator and battery charging, will not operate when the motorhome is running.

CHECK all motorhome equipment is set-up to accept the site supply before actually switching on.

MAXIMUM BULB RATINGS FOR INTERNAL LIGHTS

<u>Type of Light</u>	<u>Maximum Bulb Rating</u>
Front locker light	20 watts
Downlighters	1.2 watts
Reading lights	1.2 watts
Floor LED	0.36 watts
Under locker strip lights 300mm	1.2 watts
Under locker strip lights 600mm	2.2 watts
Awning lights	10 watts

Please note: Ensure that you only replace a blown bulb with one of the same rating. Never replace a bulb with one with a higher rating. You should ensure that when fitted, no bulb is in contact with the surface of the lamp or shade.

Note: All LED lights can only be replaced with a new complete unit and not a replacement bulb.

CAUTION: The reading lights will become hot when in use. Do not touch the bulb when they are illuminated and allow sufficient time for them to cool after switching off. It is recommended to set the position of the reading light before switching on.

CAUTION: Do not look directly at LED lights.



MAINS UNIT - ACCORDO

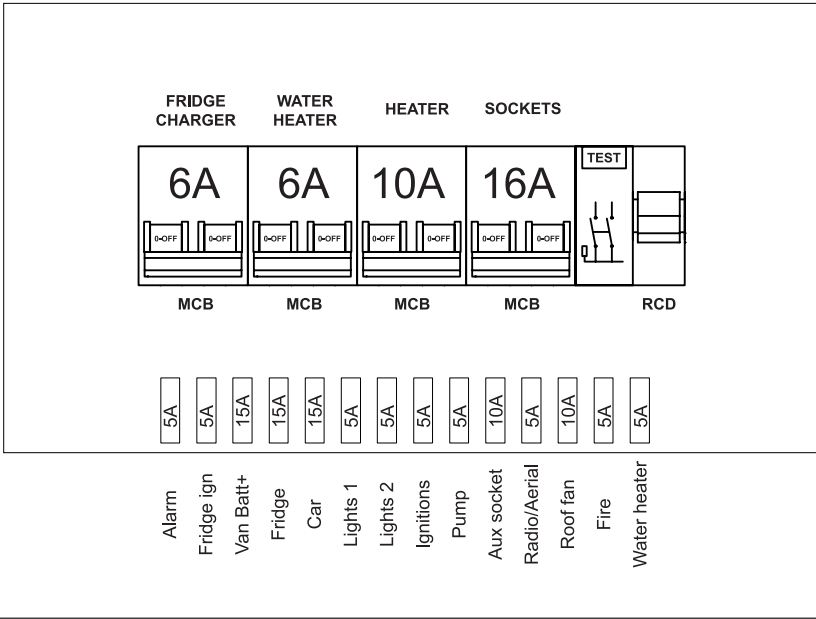



HOW TO USE YOUR MOTORHOMES EQUIPMENT

Within this section of your motorhomes handbook we will give you brief details on how to operate all of the motorhomes equipment from the gas cooking equipment to the window blinds. For further details on the major equipment within your motorhome please read the individual appliance instructions contained with your user information pack.

Please note: Before attempting to use any gas equipment please ensure that the gas bottle is connected securely to the motorhomes regulator via a high pressure gas hose and the bottle valve is in the on position. Also ensure the appliance isolation valves are in the on position as shown in the gas system section.

Please note: Before attempting to use any electrical appliance please ensure that you have connected the mains connection cable to a mains hook up and that the mains isolation switch is in the on position. Ensure the 12V master switch is in the ON position. This is found in the side of the unit next to the entrance door.



MAIN ENTRANCE DOOR HANDLE OPERATION

Your new Accordo Motorhome will be fitted with the following type of door handle and it is operated as described below.

When the door is unlocked the door indicator will be shown as green

In order to lock the door, pull the door closed with a moderate force, then push the centre lever down until the indicator is showing red, as shown in Figure 1. This will ensure the door is locked and the door must be in this position when the vehicle is in motion.

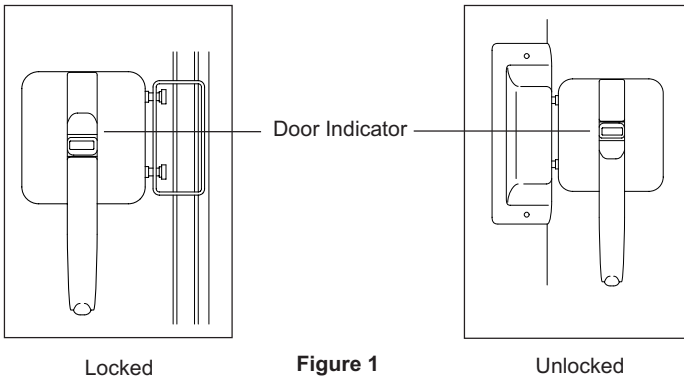

In order to open the door, pull the centre lever towards you, shown in Figure 2. Please note that this will automatically unlock the door even if the door handle is in the locked position.

Please note: Under no circumstance must the main door be operated when the vehicle is in motion. Should the door open during transit, please pull your motorhome over before operating the door.

Habitation Door

Note: Please ensure you only remove the key from the door with the key in the vertical position.

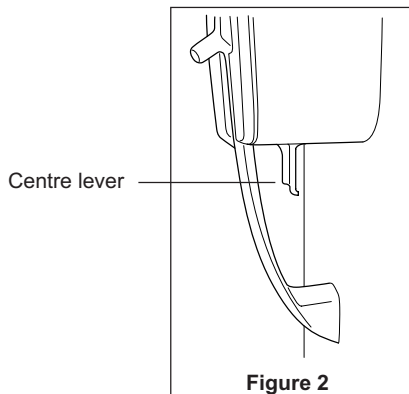



CONTROL PANEL

Your new Elddis Accordo Motorhome is fitted with the control panel shown below.

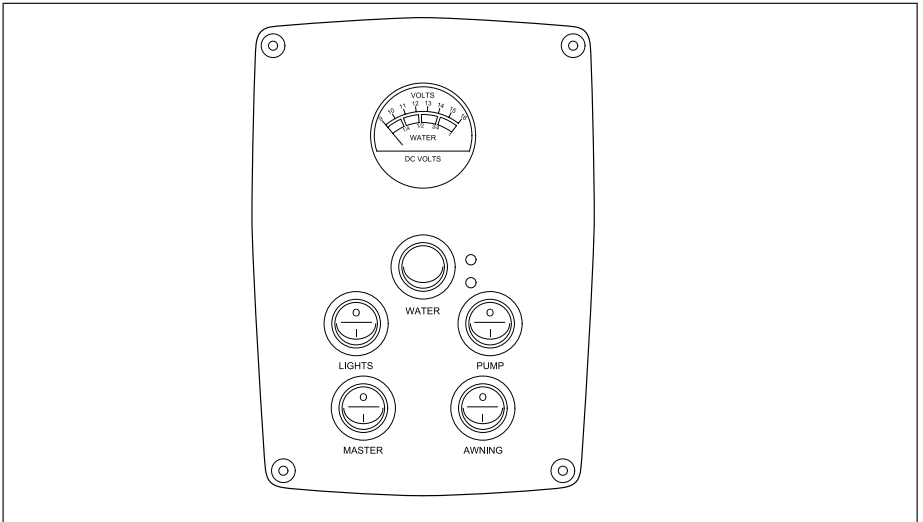

Each switch is clearly marked to identify what it operates.

In order for any of the electrics in your motorhome to operate from the auxiliary battery you must first ensure that the **master switch** is in the 'I' position.

The **light switch** on the control panel operates the main lounge area lights..

You must place the **pump switch** to the 'I' position in order for the water pump to operate and to enable water to be run to any of the water taps.

The **awning switch** operates the outside awning light.

The **green LED light** will illuminate when the pump is running.

The **red LED light** will illuminate when the waste tank is full.



COOKING EQUIPMENT

WARNINGS

- (i) All pans should be mounted centrally over the burners, even when cooling, to protect adjacent walls.
- (ii) Do not lower the glass cover until hob has cooled down.
- (iii) Glass lids may shatter when heated. Turn off all burners and grill before shutting the lid. The glass cover should be raised when operating the grill.
- (iv) Accessible parts may be hot when the grill and oven are in use. Young children should be kept away.
- (v) Do not use grill or oven as a space heater.
- (vi) When you are cooking it is essential to provide additional ventilation, such as opening windows near grill, cooker and oven.

Gas Hob

- (i) Turn the individual control knob for the burner you wish to light.
- (ii) The depressing of the control knob overrides the flame failure device fitted to the burner. Light the burner using a safety gas lighter. If the burner fails to light within 20 seconds then release the control knob and wait 30 seconds before trying again.
- (iii) Once the burner lights it will be necessary to keep the control knob depressed for about 5 to 10 seconds to ensure that the flame failure device is heated up enough to operate.

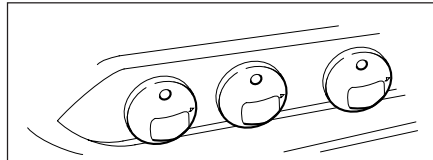

Burner controls

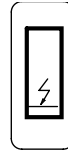

Ignitor button



Gas Grill

- (i) Turn the grill control knob to the high flame position and with the knob depressed light the burner using a gas safety lighter. If the grill does not light within 20 seconds then turn off the grill control knob for at least 30 seconds before trying again.
- (ii) Once the grill lights it will be necessary to keep the grill control knob depressed for 5 to 10 seconds to ensure the flame failure device is heated enough to operate.

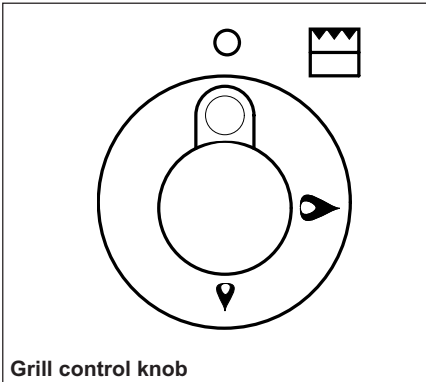

Grill control knob

Gas Oven

- (i) Turn the gas oven control knob to maximum then depress the knob then light the burner using a gas safety lighter. If the oven does not light within 20 seconds turn off the control knob and wait for 30 seconds before trying again.
- (ii) Once the oven is lit it will be necessary to keep the control knob depressed for 5 to 10 seconds to ensure the flame failure device is heated up enough to operate.

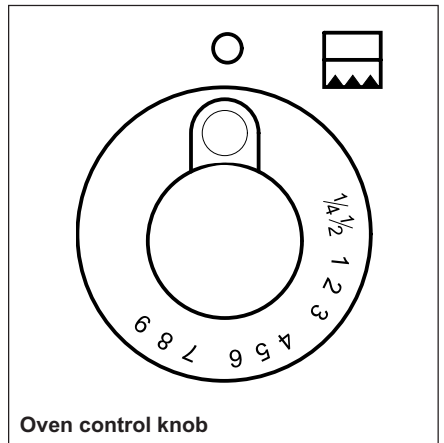

Oven control knob



REFRIGERATOR

Your new Elddis Motorhome is fitted with a Dometic refrigerator. Details of how to operate your fridge are shown below:

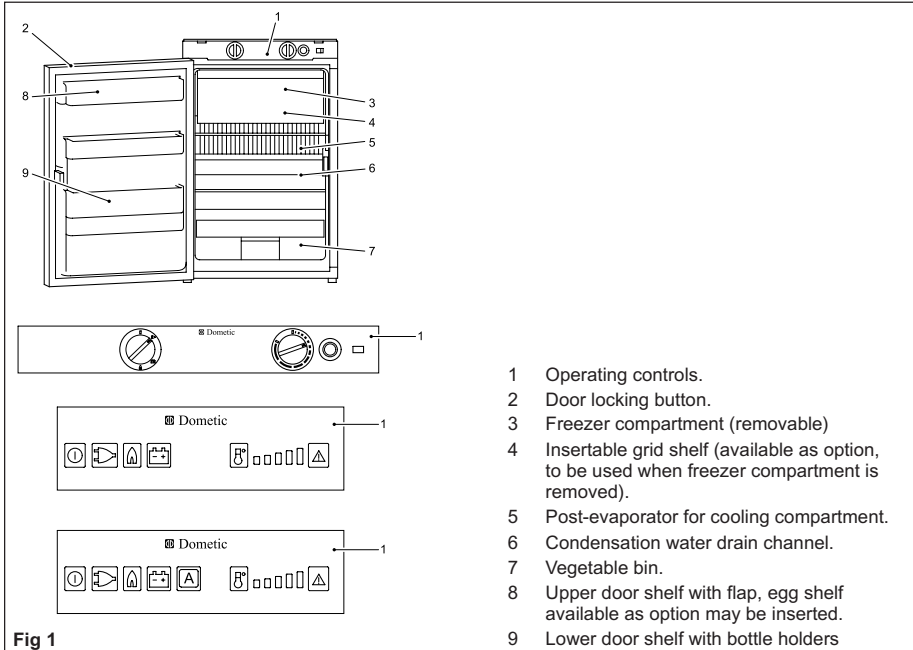

- 1 Operating controls.
- 2 Door locking button.
- 3 Freezer compartment (removable)
- 4 Insertable grid shelf (available as option, to be used when freezer compartment is removed).
- 5 Post-evaporator for cooling compartment.
- 6 Condensation water drain channel.
- 7 Vegetable bin.
- 8 Upper door shelf with flap, egg shelf available as option may be inserted.
- 9 Lower door shelf with bottle holders

Fig 1

The refrigerator is equipped to operate on three power modes:

- Mains voltage (230V AC)
- Direct current voltage (12V DC)
- Gas (liquid gas, propane/butane)

Select the desired power mode by the energy selector switch (battery igniter type models) or the energy selector button (MES, AES). Appliances with automatic energy selection (AES) are additionally provided with "automatic mode" function. Then the AES system automatically selects the best energy source for each particular situation.

The cooling unit is silent in operation.

When the appliance is first put into operation, there may be a mild odour which will disappear after a few hours.

The refrigerator will take several hours to reach its operating temperature in the cooling compartment. The freezer compartment

should be cold about one hour after switching on the refrigerator.

Cleaning

Before starting up the refrigerator, it is recommended that you clean it inside and repeat this at regular intervals.

Use a soft cloth and lukewarm water with a mild detergent. Then wipe out the appliance with clean water and dry thoroughly.

To avoid material alterations, do not use soap or hard, abrasive or soda-based cleaning agents. Do not allow the door seal to come into contact with oil or grease.

Maintenance

In compliance with applicable regulations, please note that the gas unit and the connected ventilation ducts must be checked by an authorised technical personnel after first use and after every other year for



compliance with the European Standard EN 1949. A test certificate has to be issued. **It is the user's responsibility to arrange this test.**

The gas burner must be inspected and cleaned as necessary, at least once a year. When using liquefied petroleum gas (tank or refill cylinders) the maintenance interval is reduced to half-yearly or quarterly.

Keep the evidence of maintenance work carried out on your refrigerator.

Work on gas and electrical equipment shall be carried out by qualified personnel only.

It is recommended that this is carried out by an authorised customer services department.

We recommend maintenance following an extended shutdown of the vehicle. Please contact our customer services.

Electrical operation

12V voltage (on-board power supply)

CAUTION: The refrigerator should only be used in 12V DC operation while the vehicle's engine is running, otherwise the on-board battery would be discharged within a few hours!

Appliances with battery igniter (manual energy selection)

Electrical operation

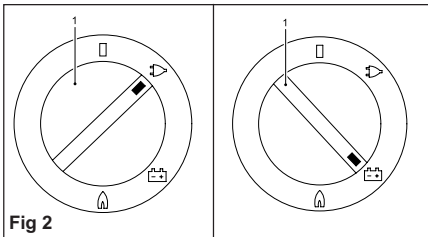

Fig 2

Switch on the appliance by turning the energy selection switch (1) clockwise to position:

 230V operation,

 12V operation

Gas operation (Liquid gas)

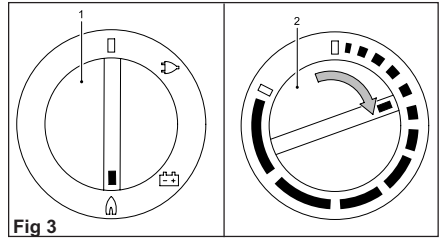



Fig 3

1. Turn the rotary selector switch (1) to position 
2. Turn the temperature selector (2) clockwise and push. Keep the controller button depressed.

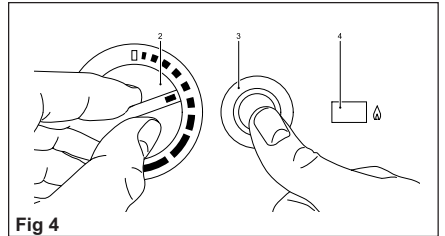

Fig 4

3. Then, press knob (3) of battery igniter down and keep it depressed. The ignition process is activated automatically.
4. Once the flame ignites, the pointer of galvanometer (4) begins moving into the green range. The refrigerator is operational. Keep knob (2) depressed for approx. 15 seconds and finally release it.

Setting of cooling compartment temperature

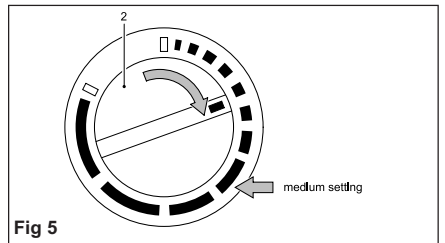

Fig 5

Select the desired cooling compartment temperature by turning the rotary knob (2).



The scale starts with **MIN** position (small bar = highest temperature) and climbs up to **MAX** position (large bar = lowest temperature).

Note: The temperature levels do not relate to absolute temperature values.

12V: The refrigerator operates without thermostatic control (continuous operation).

Mains power (230V)

CAUTION: This option should only be selected where the supply voltage of the connection for power supply corresponds to the value specified on the data plate. Any difference in values may result in damage to the appliance.

Gas operation (Liquid gas)

- The refrigerator must be operated using liquid gas (propane, butane) (no natural gas or town gas).
- When using LPG gas, please consider that the burner needs cleaning at shorter intervals due to the gas combustion method (2-3 times per year recommended).
- In Europe, gas operation is permitted while travelling only on the condition that the gas system of the vehicle is equipped with a hose rupture protection. The national regulations of the respective country must be observed.
- For physical reasons, gas ignition faults could occur starting from an altitude above sea level of approx. 3280 ft. / 1000m (No malfunction).
- On the initial refrigerator start-up or after a cylinder change, air may be trapped in the gas line. To purge the air from the lines, switch on the refrigerator and any other gas appliances (e.g. stove) for a short time. The gas ignites without delay.
- Each refrigerator with manual ignition is equipped with an automatic flame safety valve which interrupts the gas supply automatically after approx. 30 seconds when the flame has extinguished.

WARNING: As a basic rule, gas operation is prohibited in petrol stations!

Prior to starting the refrigerator in gas mode:

- Open the gas cylinder valve.
- Open the shut-off valve for gas supply to the refrigerator.

Explanation of operating controls

Manual energy selection/manual ignition battery igniter:

- 1 = Power On switch/Energy selector switch
- 2 = Temperature controller
- 3 = Battery igniter (gas)
- 4 = Flame indicator (galvanised)

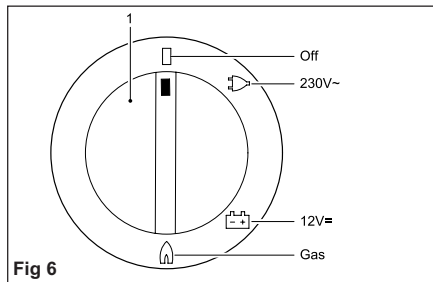

Fig 6

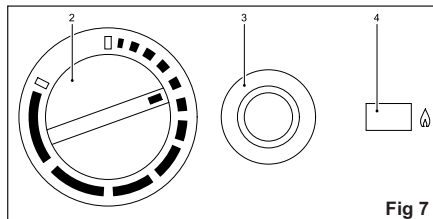

Fig 7



Door locking

Open the door by pressing the locking button and pull open.

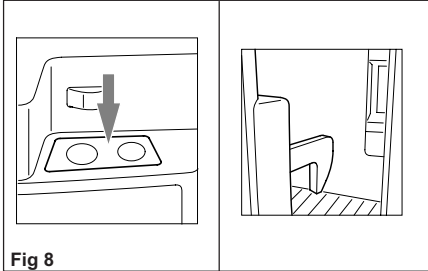

Fig 8

Shut the door again by pushing it to close. The snapping into the lock can be heard.

Note: If the vehicle is stationary for a long period, the locking hook may be clamped by means of a lockbar. The door may now be opened by just pulling it without need of pressing the locking button. See below.

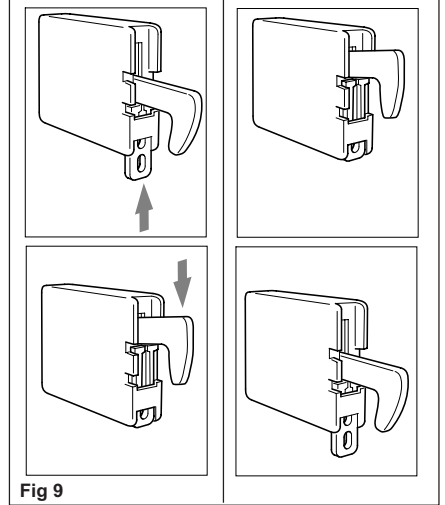

Fig 9

CAUTION: As a basic rule, shut and lock the door before starting your journey.

Positioning the shelves

The shelves may be pulled out by smoothly lifting them, and may be positioned as desired.

Removable freezer compartment

The freezer compartment may be removed to enlarge the cooling compartment.

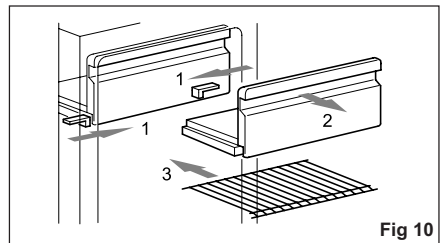

Fig 10

Unlock the freezer compartment on both sides (1)

Pull the freezer compartment out (2) and store safely.



An additional shelf (3) may be installed, if required. This may be obtained from Dometic.

Storing food in the cooling compartment

- Switch the refrigerator on approx 12 hours before filling
- Always store pre-cooled food. Make sure that food is well cooled when it is bought and also when transporting it – use insulated cool bags.
- Keep the door open for the minimum time possible.
- Food must be packed, in closed containers or wrapped in foil, and stored separately from each other, to prevent drying out or odours.
- Allow foods that have been warmed to cool down before storing.
- Ensure that air circulation of the cooling unit is not obstructed. Keep the ventilation grilles free from obstructions.

Storing food in the freezer compartment

- Do not keep carbonated drinks in the freezer.
- The freezer compartment is suitable for making ice cubes and for short term storage of frozen foods. It is not suitable as a means of freezing foods.

Note: When ambient temperatures are lower than +10°C and the refrigerator is exposed to these temperatures for extended periods an even regulation of freezer temperature cannot be guaranteed for system-related reasons. This can cause the temperature in the freezer to rise and stored goods to melt.

Making ice cubes

Ice cubes are best made over night, when the refrigerator has less work to do and has more reserves.

Defrosting

In time, frost builds up on the fins inside the refrigerator. A layer of frost thicker on one side may occur but does not mean a malfunction. When this layer of frost is about

3mm thick, the refrigerator should be defrosted. To do this:

- Switch off the refrigerator as described later.
- Remove all food and the ice cube tray.
- Leave the door open to allow air to enter and prevent formation of mildew.
- After defrosting (freezer compartment and fins free of frost), wipe both cooling compartments dry with a cloth.

Note: Water thawing in the main compartment of the refrigerator runs into a container at the back of the refrigerator, from where it evaporates.

CAUTION: The layer of ice must never be removed forcibly, nor may defrosting be accelerated using a heat source.

Shutting off the refrigerator

Press the mode button (1) and keep pressed for 2 seconds. The display will disappear and the appliance is fully switched off.

Release the locking mechanism of the door lock by pushing it and shift it to the front. If the door is shut in this position, a small gap is maintained to prevent the formation of mildew.

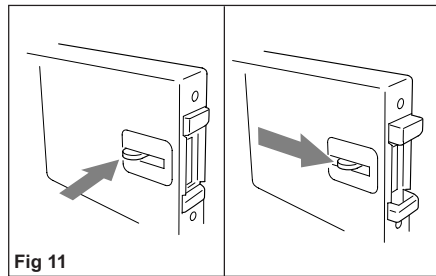

If the refrigerator is taken out of service for an extended period, close the isolation tap and the gas cylinder valve.







Winter operation

In winter, check that the ventilation grilles and the exhaust duct have not been blocked by snow, leaves etc. When the outside temperature falls below +10°C the winter covers should be fitted. This protects the unit from excessively cold air which could have adverse effects on the performance of the unit.

Note: The winter covers should also be attached if the vehicle is taken out of service for an extended period, or while it is being cleaned on the outside.

Failure display

Your refrigerator will indicate a malfunction by flashing of the failure indicator LED (4) and one of the other display lights. The chart below shows the meaning of these.

Display:	Failure:
 LED is flashing	230V mode: "230V" not available or voltage too low
 LED is flashing	12V mode: "12V" not available or voltage too low
 LED is flashing	GAS/Auto mode: Flame not ignited
All temperature setting LEDs are flashing	Temperature sensor defective, refrigerator work on mid temperature setting
 LED + all temperature	230V - Heating element defective
 LED + all temperature	12V - Heating element defective setting LEDs are flashing



Troubleshooting

Before contacting your dealer or authorised service centre, please check whether:

- The instructions for correct operation of the refrigerator have been observed.
- The refrigerator is standing level.
- It is possible to operate the refrigerator with any available power source.

Failure: The refrigerator does not cool sufficiently

<i>Possible cause</i>	<i>Action you can take</i>
• Inadequate ventilation to the unit.	• Check that the ventilation grilles are not covered.
• Thermostat setting is too low.	• Set thermostat to a higher level.
• The condenser is heavily frosted.	• Check that the refrigerator door closes properly.
• Too much warm food has been stored within short period of time.	• Allow warm food to cool down before storage.
• The appliance has been running for only a short period of time.	• Check whether the cooling compartment works after approx. 4-5 hours.
• Ambient temperatures too high.	• Regularly remove ventilation grilles.

Failure: The refrigerator does not cool in gas operation mode

<i>Possible cause</i>	<i>Action you can take</i>
• Gas cylinder empty.	• Change gas cylinder.
• Is the upstream shut-off device open?	• Open shut-off device.
• Air in the gas pipe?	• Switch off the appliance and start again. Repeat this procedure 3-4 times, if necessary.

Failure: The refrigerator does not cool in 12V operation

<i>Possible cause</i>	<i>Action you can take</i>
• On-board fuse defective.	• Fit new fuse.
• On-board battery discharged.	• Check battery, charge it.
• Engine not running.	• Start engine.
• Heating element defective (please also refer to failure indication).	• Please inform the Dometic Customer Services.



Troubleshooting (continued)

Failure: The refrigerator does not cool in 230V operation

Possible cause

Action you can take

-
- | | |
|--|--|
| • On-board fuse defective. | • Fit new fuse. |
| • Vehicle not connected to mains supply voltage. | • Make a connection to a mains power supply. |
| • Heating element defective (please also refer to failure indication). | • Please inform the Dometic Customer Services. |
-



WHALE UNDERFLOOR SPACE HEATER

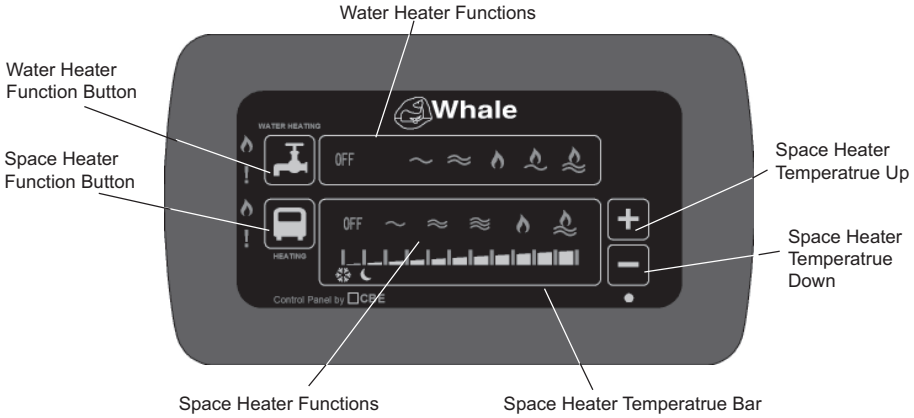

Operating Instructions

For operation of the Space Heater, a 12 V d.c. supply must be connected at all times. To operate the Space Heater's electric elements, it must also be connected to a suitable 230V a.c. supply.





To operate the Space Heater, cycle through the power functions by pressing the Space Heater Function button.



Space Heater Power Functions Available:

Gas Operation

For gas operation; press the space heater function button  until the 'Gas On'  icon is illuminated.

There will be a pre-purge pause of approx. 30 seconds to allow any un-burnt gas to leave the flue.

When the icon below is lit green, flame ignition has been successful.



If there is air in the gas supply line, it may take a few attempts for the gas to ignite. See the Troubleshooting Guide, for gas lockout resetting. If gas ignition is not satisfactory, the below symbol will light red to indicate a fault. See the Troubleshooting Guide, for identifying and clearing a fault.





Electric Operation

The Space Heater is equipped with 3 electric power settings; 500W / 1000W / 2000W.



500W

To select 500W; press the space heater function button  until the '500W' icon is illuminated. 

1000W

To select 1000W; press the space heater function button  until the '1000W' icon is illuminated. 

2000W

To select 2000W; press the space heater function button  until the '2000W' icon is illuminated. 



When operating on 500W and 1000W the blown air fan runs at a reduced speed to minimise noise and current draw.

Please note: The electric elements will still operate if the appliance is in gas ignition lockout.



Gas & Electric Operation

For maximum heat output, the Space Heater can be operated on Gas and Electric together. This gives a total heat output of 4kW.

To select Gas and Electric; press the space heater function button  until the 'Gas and Electric' icon is illuminated. 

Switching the Appliance Off

To turn the Space Heater off; press the space heater function button  until the 'Off' icon is illuminated. 

Adjusting the Temperature

To adjust the temperature, press

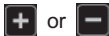

The temperature is indicated by the temperature bar.





The Space Heater will automatically turn itself on and off to maintain the select temperature.

The Space Heater will continue to run for 3 minutes after it has been switched off. This is to ensure that all gas is purged from the system

Frost Protection

A frost protection setting is available. This maintains a low temperature throughout your vehicle in cold weather.

To activate Frost Protection; select 500W or Gas Only.

Then press  to move the temperature light above the 'Frost Protection' icon. 

Night Time Setting

When using the Space Heater at night time, Whale recommends that you select 500W and set the temperature light to above the 'Moon' icon 

Maintenance

The outside of the Space Heater does not normally require cleaning. If the surface needs cleaned, you must isolate the electric supplies and wipe down with a soft, damp cloth only. Do not use abrasive cleaning agents. Allow to fully dry before reconnecting the electrical supplies.

Servicing

Whale recommends that the Water Heater must be inspected, at least annually by a Whale Approved Service Centre or Engineer. This must be in accordance with the practice in the country where it is used and according to the Whale Instructions (provided separately). Annual testing of the gas soundness and combustion must be carried out by an accredited LPG Gas Engineer. The Space Heater contains ESD sensitive components and must only be opened by a Whale Approved Service Centre or Engineer.

Winterising

When using the Space Heater in winter, you must ensure that the Flues are not blocked by fallen leaves or snow etc. When the Space Heater will not be used for a long period of time, e.g. in winter storage, you must cover the open end of the combustion air and exhaust flue to prevent ingress of leaves etc.



Troubleshooting Guide

The Space Heater is equipped with an electric diagnostic system which will detect fault conditions, ranging from poor gas or d.c. supply to internal Space Heater malfunctions.

In the unlikely event of a failure, the red diagnostic light on the Control Panel will indicate a fault.





To identify the reason for the fault, you must press and hold.



The number of bars lit on the temperature bar represents the fault code. e.g. if one bar is lit, this is fault one.

Number of Bars Lit	Fault	Remedy
1	No Flame Detected	Check gas supply, ensuring there is gas in the bottle and no blockage in the gas line. Ensure that propane is used at temperatures below +5°C. Clear lockout as described below.
2	Overheat	Check the air ducts and vents are not blocked or restricted. Whale recommends you wait at least 5 -10 minutes to allow the Space Heater to cool, before clearing the lockout as described below.
3	Low / High Voltage Supply	When measured at the Space Heater, minimum operating voltage is 10 V d.c. and maximum operating voltage is 15 V d.c. Check battery voltage at the Space Heater, if voltage is between 10 V d.c. and 15 V d.c., check connections between the Space Heater and the battery. Clear lockout as described below.
4	Combustion Air Fault	Check combustion air inlet and exhaust flues for blockages. When blockage is removed, clear lockout as described below.
5	Other / Internal Fault	Attempt to clear lockout as described below. If this fails, please contact Whale Support on +44 (0) 8452172933.

Lockouts

When the lockout fault has been identified, it can be cleared by pressing  and  until the fault code clears from the temperature bars.

It will take a few seconds for the red diagnostic light on the control panel to clear. Wait until this has cleared before operating the Space Heater.

Please note: A cycling of the power supply will not clear a lockout. A gas lockout (Fault 1 and 5) will still permit use of the appliance in electric only operation.

If the problem persists, please contact Whale Support on +44 (0) 8452172933.



WHALE WATER HEATER

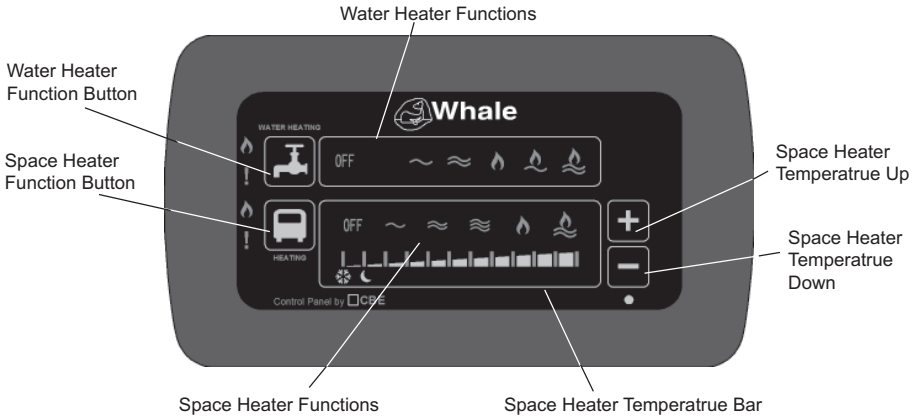

Operating Instructions

For operation of the Water Heater, a 12 V d.c. supply must be connected at all times. To operate the Water Heater's electric elements, it must also be connected to a suitable 230V a.c. Supply.

If there is air in the gas supply line, it may take a few attempts for the gas to ignite. See the troubleshooting guide, for gas lockout resetting. If gas ignition is not satisfactory, the below symbol will light red to indicate a fault. See the troubleshooting guide, for identifying and clearing a fault.





To operate the Water Heater, cycle through the power functions by pressing the Water Heater Function button. 

Electric Operation



The Water Heater is equipped with 2 electric power settings; 750W / 1500W.

Water Heater Power Functions Available:



750W

To select 750W; press the water heater function button  until the '750W icon is illuminated. 

Gas Operation

For gas operation; press the water heater function button  until the 'Gas On' icon is illuminated. 

1500W

To select 1500W; press the water heater function button  until the '1500W icon is illuminated. 

There will be a pre-purge pause of approx. 30 seconds to allow any un-burnt gas to leave the flue.

When the icon below is lit green, flame ignition has been successful.

Please note: The electric elements will still operate if the appliance is in gas ignition lockout.







Gas and Electric Operation

The Water Heater can be operated with both gas and electric at the same time. Gas and Electric settings available are; Gas and 750W / Gas and 1500W.



Gas and 750W

To select Gas and 750W; press the water heater function button  until the 'Gas and 750W' icon is illuminated. 

Gas and 1500W

To select Gas and 1500W; press the water heater function button  until the 'Gas and 1500W' icon is illuminated. 

Switching the Appliance Off

To turn the Water Heater; press the water heater function button  until "OFF" icon is illuminated. 

Draining the Water Heater

To drain the Water Heater switch off the Water Pump at the mains switch, open all of the hot water taps in the vehicle and operate the drain valve fitted to the Water Heater. The drain valve must be left in the 'open' position to ensure all the water drains out.

Maintenance

To clean and sterilise the Water Heater, use diluted sterilising fluid and fully rinse through with clean water afterwards. The outside of the Water Heater should not normally require cleaning. If the surface needs cleaned, you must isolate the electric supplies and wipe down with a soft, damp cloth only. Do not use abrasive cleaning agents. If descaling of the Water heater is required, this can be done by using 'Kettle Clear' or an equivalent product. You must fully rinse through with clean water afterwards.

Servicing

Whale recommends that the Water Heater must be inspected, at least annually by a Whale Approved Service Centre or Engineer. This must be in accordance with the practice in the country where it is used and according to the Whale Instructions (provided separately). Annual testing of the gas soundness and combustion must be carried out by an accredited LPG Gas Engineer. The Water Heater contains ESD sensitive components and must only be opened by a Whale Approved Service Centre or Engineer.

Winterising

When using the Water Heater in winter, you must ensure that the flue is not blocked by fallen leaves or snow etc.

When the Water Heater is not in use e.g. in winter storage, you must ensure that the Water Heater is fully drained. This is very important in cold temperatures to protect against freezing.



Troubleshooting Guide

The Water Heater is equipped with an electric diagnostic system which will detect fault conditions, ranging from poor gas or d.c. supply to internal Water Heater malfunctions.

In the unlikely event of a failure, the red diagnostic light on the Control Panel will indicate a fault.





To identify the reason for the fault, you must press and hold. 

The number of yellow bars lit on the temperature bar represents the fault code. e.g. if one bar is lit, this is fault one.

Number of Bars Lit	Fault	Remedy
1	No Flame Detected	Check gas supply, ensuring there is gas in the bottle and no blockage in the gas line. Ensure that propane is used at temperatures below +5°C. Clear lockout as described below.
2	Overheat	Check there is water in the Water Heater. Whale recommends you wait at least 5 -10 minutes to allow the Space Heater to cool, before clearing the lockout as described below.
3	Low / High Voltage Supply	When measured at the Space Heater, minimum operating voltage is 10 V d.c. and maximum operating voltage is 15 V d.c. Check battery voltage at the Space Heater, if voltage is between 10 V d.c. and 15 V d.c., check connections between the Space Heater and the battery. Clear lockout as described below.
4	Other / Internal Fault	Attempt to clear lockout as described below. If this fails, please contact Whale Support on +44 (0) 8452172933.

Lockouts

When the lockout fault has been identified, it can be cleared by pressing  and  until the fault code clears from the temperature bars.

It will take a few seconds for the red diagnostic light on the control panel to clear. Wait until this has cleared before operating the Space Heater.

Please note: A cycling of the power supply will not clear a lockout. A gas lockout (Fault 1 and 5) will still permit use of the appliance in electric only operation.

If the problem persists, please contact Whale Support on +44 (0) 8452172933.



Smoke Alarm

Operation

The smoke alarm is operating once a fresh battery is installed and testing is complete. When products of combustion are sensed, the unit sounds a loud 85db pulsating alarm until the air is cleared.

Hush Control - The "HUSH" feature has the capability of temporarily desensitising the alarm circuit for approximately 8 minutes. This feature is to be used only when a known alarm condition, such as smoke from cooking activates the alarm. If the smoke is not too dense, the alarm will silence immediately and the Red LED will flash once every 10 seconds for approximately 8 minutes. This indicates that the alarm is in a temporarily desensitised condition. The smoke alarm will automatically reset after approximately 8 minutes and sound the alarm if particles of combustion are still present. The "HUSH" feature can be used repeatedly until the air has been cleared of the condition causing the alarm.

Note: Dense smoke will override the hush control feature and sound a continuous alarm.

CAUTION: Before using the alarm hush feature, identify the source of the smoke and be certain a safe condition exists.

Flashing LED Light - This smoke alarm is equipped with a flashing red indicator light. The light is located under the test button and will flash every 40 seconds to indicate that the smoke alarm is receiving power.

Testing - Test by pushing the test button on the cover and holding it down for a minimum of 5 seconds. This will sound the alarm if the electronic circuitry, horn and battery are working. If no alarm sounds, the unit has defective batteries or other failure. **DO NOT** use an open flame to test your alarm, you could damage the alarm or ignite combustible materials and start a structure fire.

TEST THE ALARM WEEKLY TO ENSURE PROPER OPERATION.

Erratic or low sound coming from your alarm may indicate a defective alarm and it should be returned for service.

Note: Weekly testing is required.

Nuisance Alarms

Smoke alarms are designed to minimise nuisance alarms. Cigarette smoke will not normally set off the alarm, unless the smoke is blown directly into the alarm. Combustion particles from cooking may set off the alarm if the alarm is located close to the cooking area. Large quantities of combustible particles are generated from spills or when boiling. Using the fan on a range hood which vents to the outside (non-recirculating type) will also help remove these combustible products from the kitchen. If the alarm does sound, check for fires first. If a fire is discovered, get out and call the fire department.

Maintenance

Battery Replacement

Note: Replacement batteries are available where you purchased your alarm.

The smoke alarm is powered by a 9V battery. A fresh battery should last for one year under normal operating conditions. This alarm has a low battery monitor circuit which will cause the alarm to "chirp" approximately every 30-40 seconds for a minimum of seven days when the battery gets low. Replace the battery when this condition occurs.

Note: Use only the following 9 volt batteries for smoke alarm battery replacement:

Alkaline Type: Energizer 522; Duracell MN1604, MX 1604; Gold Peak 1604A.

Note: Weekly testing is required.

WARNING: Use only the batteries specified. Use of different batteries may have a detrimental effect on the smoke alarm.

Cleaning your alarm

Your alarm should be cleaned at least once a year.

To clean your alarm, remove it from the mounting bracket. You can clean the interior of your alarm (sensing chamber) by using compressed air or a vacuum cleaner hose and blowing or vacuuming through the openings around the perimeter of the alarm. The outside of the alarm can be wiped with a damp cloth.

After cleaning, reinstall your alarm and test it by using the test button. If cleaning does not restore the alarm to normal operation the alarm should be replaced.



CARBON MONOXIDE ALARM

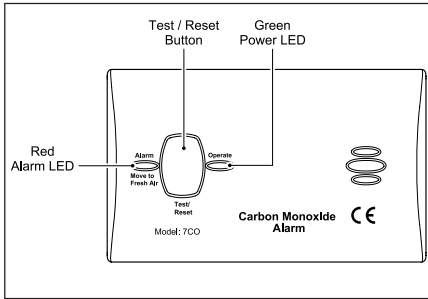

Switching on your CO alarm

Note: Your CO alarm must be installed by a competent person using the following guidance:

- Remove the batteries from the pack and insert them into the battery compartment. Make sure that you fit the batteries correctly to the polarity markings (+ or -) shown within the battery compartment. If correctly installed the alarm will give a short beep.
- To test the alarm, press the test button. The alarm will beep once followed by 4 loud pulses, then a brief pause and then 4 more pulses, ending with a single beep.
- Check that the green LED flashes at 30 second intervals to show that the alarm has power. This is easiest to see in a dark area, or with lights switched off.

Recognising alarm signals and warnings

Feature	What this means	Required Action
Green LED flashes every 30 seconds	Normal operation	None
The alarm chirps every 60 seconds and the red LED flashes	Low batteries	Replace batteries as soon as possible
Alarm chirps twice every 30 seconds and the red LED flashes twice	End of life of the alarm	Replace the alarm
Alarm chirps every 30 seconds and red LED flashes every 30 seconds	Fault	Replace the alarm
Red LED on and constant tone	Malfunction	Replace the alarm
Loud continuous alarm with the red LED	Dangerous levels of CO have been detected	Follow emergency procedures.

Using your alarm

Testing

Test your alarm each week by pressing the test button. The alarm will beep once followed by 4 loud pulses, then a brief pause and then 4 more pulses, ending with a single beep. While in full alarm the red LED will flash for 10 seconds.

This confirms that the alarm is powered up and working.

Re-setting the alarm

If the alarm sounds, the test/reset button will silence the alarm unless it is still detecting dangerous levels of CO. The green light will then flash every 30 seconds to indicate that the alarm has power.

Replacement of batteries

Under normal operating conditions, the batteries will last a minimum of one year. These batteries can be purchased from your local retailer.



End-of-life - This alarm will chirp every 30 seconds with a red LED flash after at least 10 years operation to let you know it has reached its end of life. A replacement needs to be purchased.

Carbon Monoxide Alarm Procedure

What to do if your alarm sounds

If alarm sounds (4 loud audible pulses followed by a pause for 5 seconds):

- Immediately move to fresh air - outdoors or by an open door/window. Do a head count to check that all persons are accounted for. Do not re-enter the motorhome nor move away from the open door/window until the emergency services responders have arrived, the motorhome has been aired out and your alarm remains in its normal condition.
- Call Gas Emergency Services: 0800 111 999 or your local Gas Safe Registered Engineer.

Never restart the source of the CO problem until it has been corrected. Never ignore the sound of the alarm! If the alarm is sounding, pressing the test/reset button will terminate the alarm. If the CO condition that caused the alert in the first places continues, the alarm will reactivate. If the unit alarms again within six minutes, it is sensing high levels of CO which can quickly become a dangerous situation.

WARNING: Activation of the alarm indicates the presence of Carbon Monoxide (CO) which can kill you.

Maintenance of your alarm

To keep your alarm in good working order:

- Test every week
- Vacuum regularly to remove dust
- Keep away from solvents or detergents
- Avoid spraying air-freshener, hair-spray near the alarm
- Do not paint the alarm. If decorating or using adhesives close to the alarm, remove it temporarily.

The following substances can affect the sensor and cause false alarms.

Methane, Propane, Iso-butane, Iso-propanol, Ethylene, Benzene, Toluene, Ethyl acetate, Hydrogen Sulphide, Hydrogen, Sulphur Dioxide, alcohol based products, paints, thinners, solvents, adhesives, hair-sprays, aftershaves or perfumes and some cleaning agents.

WARNING: This Carbon Monoxide alarm is not a smoke alarm. It will not sense smoke, fire or any poisonous gas other than carbon monoxide.



ROOFLIGHTS

Your motorhome is fitted with at least one type of the following roof lights:

The Heki 2 (Option)

To Open To The Tilted Position:

- (i) Press the knob in the toggle catches on either side of the rooflight and turn through approx. 90°.
- (ii) Grasp the metal bar in the middle, snap it out of its holder, swivel down and press the rooflight upwards. (The rooflight is held by the two gas springs after approx. 150mm).
- (iii) Swivel the metal bar towards the rooflight and snap into its holder.
- (iv) To close the rooflight, proceed with steps (i to iii) in reverse order.

To Open In The Intermediate Position:

- (i) Open the toggle catches on either side of the rooflight.
- (ii) Grasp the metal bar in the middle; snap it out of its holder, swivel down and press the rooflight outwards. Rooflight is opened automatically after approx. 150mm by the two gas springs).
- (iii) Open both fasteners and swivel the metal strap towards the intermediate position and pull the rooflight down until the metal strap is stopped by the fasteners.
- (iv) To close, proceed with steps (i to iii) in reverse order.

To Open In The Ventilation Position:

- (i) Open the toggle catches on either side of the rooflight.
- (ii) Using both hands on the two toggle catches, press the rooflight up about 2cm and fasten the toggle catches in the corresponding setting.
- (iii) To close, proceed with steps (i-ii) in reverse order.

Closing The Blinds:

- (i) Take hold of the end rod (without rocker) in the recessed grip and engage in the opposite end rod (with rocker).
- (ii) Select the required position (blind/flyscreen) by moving both joined end rods together.

CAUTION: In extremely bright sunshine, the blind must only be closed two-thirds, and the rooflight must be set in the continuous airing position.

Opening The Blinds:

- (i) Move blind (end rod with rocker) right to the outside.
- (ii) Hold the recessed grip with one hand; with the other hand, press the rocker and move the blind back (do not let it recoil).

CAUTIONS:

- Do not stand on the acrylic rooflight.
- Close HEKI 2 completely before moving off.
- Do not leave your Motorhome when HEKI 2 is open.
- Please consult your supplying dealer if you have any problems or defects.
- Remove any snow/ice or dirt before opening the roof.
- Do not open when it rains or when there is a strong wind.

Standard MPK Rooflight

The MPK 400 x 400 rooflight is generally fitted in washroom areas.

- (i) Lowering the flyscreen then pressing the black control rod in towards the centre of the rooflight.
- (ii) Then while the rods are depressed, push upwards to open the rooflight.



Midi Heki Rooflight

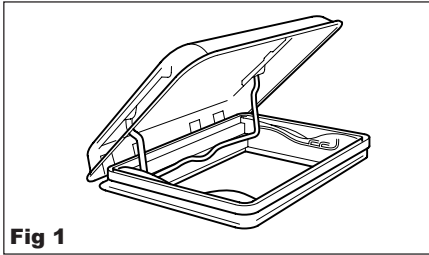

Fig 1

- (i) To open, push the large central button (Fig 2).

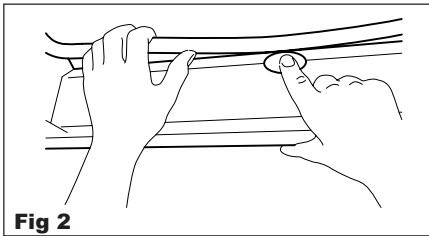

Fig 2

- (ii) Whilst depressed, slide the bar to the desired position and locate into the stops provided (Fig 3).

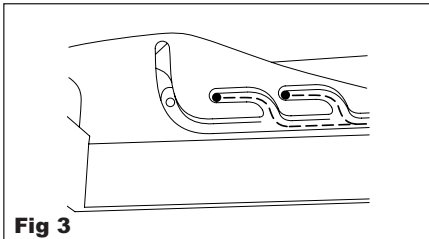
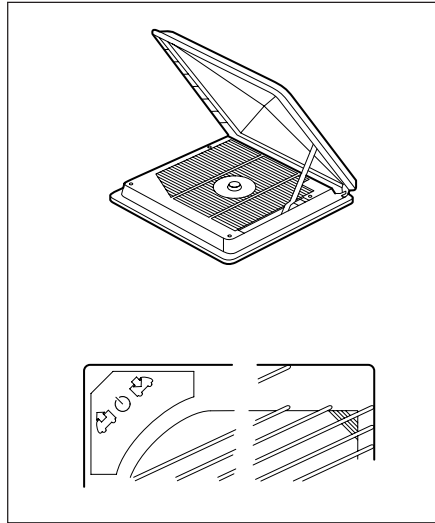

Fig 3

The Omnivent (12v) Rooflight (Option)



The Omnivent is a double-glazed roof light constructed from a synthetic ultra-violet screened material. Its side-operating mechanism allows a completely free central opening with built-in fixed ventilation when closed. It operates as an extractor fan and air intake fan.

Please note: Do not change the direction of the fan unless it has been switched off 'O' position and the blades have stopped rotating.

Door Flyscreen

The exterior door flyscreen can be opened or closed from both inside and outside of the Motorhome and does not restrict door openings.

When opening or closing the door flyscreen use the finger grip provided.

Windows

Your new Motorhome will be fitted with Polyplastic opening windows.

Polyplastic Window Opening

- (i) In order to open the Polyplastic window it is only necessary to move the catch



upwards and release the catch from the backing plate.

- (ii) The Polyplastic window should remain in the open position once opened, however if it does not then tighten the friction control on the window stays to increase the holding force.
- (iii) The Polyplastic window is also fitted with a night ventilation position where the catch is set to the centre position on the backing plate; in this position it may be possible for rain to enter the motorhome in adverse conditions.

TAPS

Kitchen Taps

Your new motorhome will be fitted with a mixer tap.

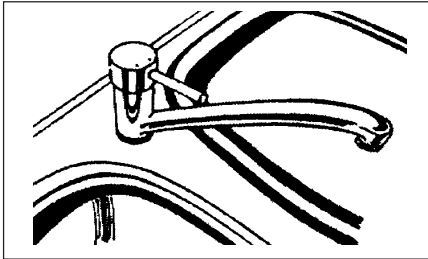

Operation

For correct operation of the tap swivel the spout to the desired position over the sink. Lift the control lever to activate the pump and allow water to flow simultaneously. To adjust the temperature, swivel the lever to the left to increase the temperature and to the right to reduce the temperature.

CAUTION: The water temperature could be very high so do not lift the lever with the tap turned to the full left position. For winter storage and to prevent frost damage the tap swivel must be left in the centre up position.

Washroom Taps And Showers

Your motorhome will be supplied with either a vanity mixer tap or separate shower mixer, or with a combined mixer tap with retractable shower head.

Operation

The mixer tap and shower mixer are operated in the same manner as the kitchen tap by lifting the control lever to activate the pump and swivelling the lever left or right to determine the temperature surface.

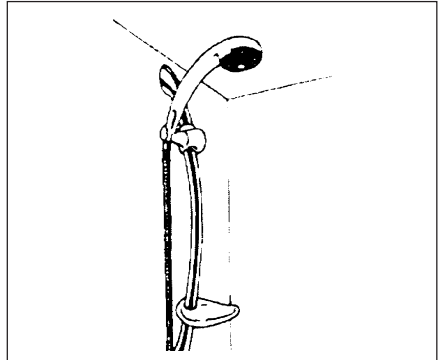

Note:

- A. The water temperature could be very high so do not lift the lever with the tap turned to the full left position.
- B. For winter storage and to prevent frost damage the tap swivel must be left in the centre up position.



INTERNAL DOORS

Toilet / Washroom Doors

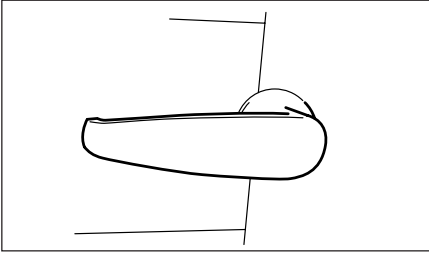

Toilet / washroom doors are fitted with a lever lock, which is operated by pushing the lever down. The lever is spring-loaded and will return to the closed position upon release. It is recommended that the lever is always used when closing the door.

The door can be locked from the inside by pushing the small lever downwards. To unlock just push the small lever up. The door can be unlocked from the outside by using a flat head screwdriver on the turnbuckle.

Inside the bathroom

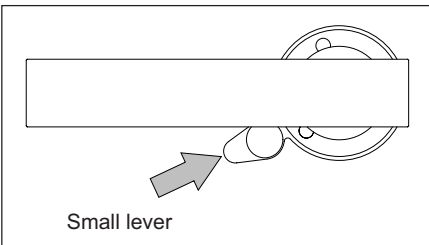

Small lever

Outside the bathroom

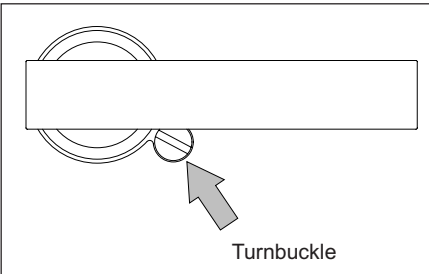

Turnbuckle

Other Internal Doors

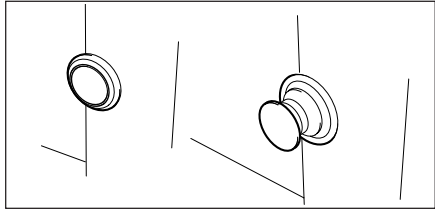

Other internal doors such as the wardrobe and table storage locker are fitted with a 2-position button lock. Push the button to lock the door and the button should remain flush with the door. Push the button again to release and the button should then protrude from the door surface.

Magnetic Catches

Magnetic catches work on contact with the metal plate on the rear of the door. Simply close the door until the magnet engages and holds the metal plate. Pulling the door towards you with a moderate force will be sufficient to disengage the magnetic catch and open the door.

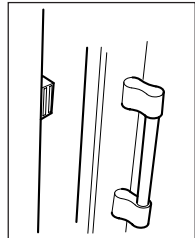

Locker Door Catches (Paddle Latch)

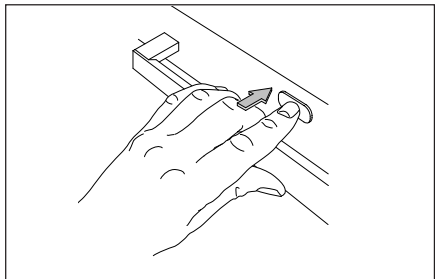

Your new Elddis Accordo Motorhome is fitted with positive locking locker doors at high level.

These are operated by pressing down on the tab within the centre of the handle to release the internal catch.



THETFORD C-260 CASSETTE TOILET RANGE

Introduction

The Thetford Cassette Toilet is a high quality product. The toilet forms an integral part of your motorhome bathroom, thanks to its functional design which combines modern styling and ease of use. The C-260 Cassette Toilet is manufactured from high quality synthetic materials which makes it a durable, user and maintenance friendly toilet.

The toilet is made up of two parts: a permanently fixed part and a Waste Holding Tank that is accessible from the outside. The removable Waste Holding Tank is located under the toilet bowl and can be removed via a door on the outside of the motorhome. The Thetford Cassette Toilet is the solution to the sanitary problem in your motorhome!

The operating instructions cover Thetford Cassette Toilet models C-260S, C-260CS (models connected to the vehicle's central water tank) and C-260CWE (model with its own flush-water tank). There are differences in the use of these models. Please ensure that you follow the instructions that apply to your toilet model.

Preparing for use (standard)

1. Open the access door on the outside of your motorhome.
2. Remove the Waste Holding Tank by pulling the safety catch (which holds the tank in place) upwards.
3. Pull the Waste Holding Tank outward to the stop. Tip it slightly and take the tank fully out.
4. Place the tank upright and turn the rotating emptying spout upwards. The emptying spout ensures that the tank can be easily and hygienically emptied.
5. Remove the cap, with the measuring cup inside, from the emptying spout and pour the correct dosage of Thetford toilet fluid (see product label) into the holding tank. This avoids unpleasant smells and keeps the inside of the tank clean. Next add approximately 2 litres of water - enough to ensure that the bottom of the Waste Holding Tank is covered. For more

information on Thetford toilet fluids, see last page of this manual. Screw the cap back onto the emptying spout and turn back to its original position.

Note: The Emptying Spout Measuring Cap is supplied in the same packaging as this manual.

WARNING: Never add toilet fluid directly via the blade or the toilet bowl as this could damage the lip seal of the Waste Holding Tank. Always pour the fluids via the emptying spout.

6. Slide the Waste Holding Tank back into its original position via the access door. Make sure that it is secured with the safety catch. Close the access door and lock it. Your Thetford toilet is now ready to use.

WARNING: Never use force if you cannot get the tank back into place easily. This may cause serious damage. If blockage occurs, always check if the blade handle is in the correct (closed) position.

7. For toilets with own Flush-Water Tank: Open the water filling door and fill the flush-water tank with the correct dosage of Aqua Rinse. This Thetford toilet fluid keeps the flush water fresh and improves the flushing. Next, fill up the flush-water tank with clean water (approximately 8 litres) using a ferry can or hose. Your toilet is now ready to use.

Preparing for use with Optional Features

8. Automatic Ventilator: Open the access door on the outside of your motorhome and remove the Waste Holding Tank (as described above).
9. Remove the filter housing cover and if no filter is present, place a new filter into the filter housing. Peel off the sticker lids on the filter. Place back the cover of the filter housing.

Using the toilet (standard)

10. Turn the bowl to the desired position with the lid closed and using both hands.
11. To activate the control panel, press the flush-button once. The control panel display will stay activated for



Standard

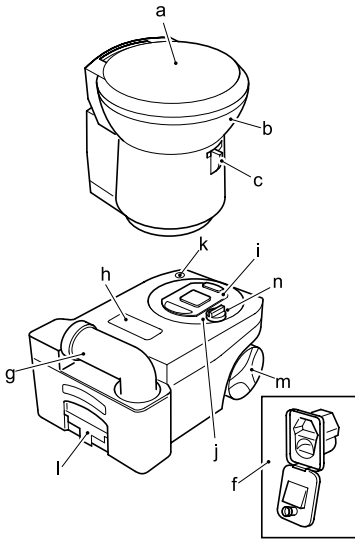

Optional features

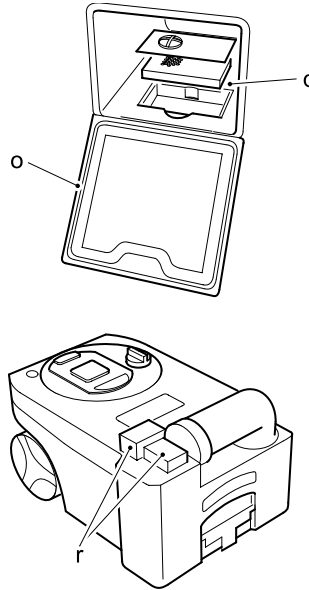

Note:
Optional features can be bought from Thetford dealerships.

Control panel (with optional features)

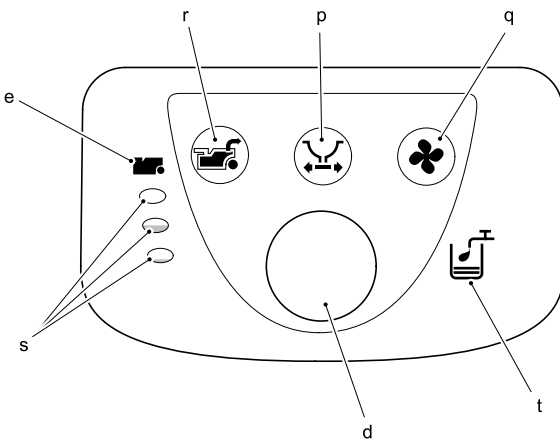

PARTS

- a) Removable Seat and Lid
- b) Swivelling Toilet Bowl
- c) Blade Handle
- d) Flush Button
- e) Waste Holding Tank Level Indicator
- f) Water Filling Door (only if toilet has own flush-water tank)
- g) Rotating Emptying Spout
- h) Automatic Pressure Release Vent
- i) Sliding Cover
- j) Removable Mechanism
- k) Vent Plunger
- l) Pull-out Handle
- m) Wheels
- n) Blade Opener
- o) Access Door to Waste Holding Tank

Optional Features

- p) Electric Blade
- q) Automatic Ventilator
- r) Waste Pump-Out System
- s) Waste Holding Tank Multi-Level Indicator
- t) Flush-Water Tank Level Indicator (only if toilet has its own flush-water tank)



approximately 5 minutes. Run some water into the bowl by pressing the flush button again briefly.

- The toilet may be used with the blade open or closed. To open the blade, slide the blade handle under the toilet bowl sideways. After use, open the blade (if still closed) and flush the toilet by pressing the flush button for several seconds (if necessary re-activate the control panel). Close the blade after use.

WARNING: If your toilet has its own flush-water tank, please make sure that you do not travel with a flush-water tank that is too full. Do not travel with water in the toilet bowl. Failure to adhere to this notice may result in water damage to your motorhome.

Using the toilet with Optional Features

- Electric Blade:** Push the electric blade button on the control display to electrically open or close the blade. In the case of failure, you can manually open or close the blade by sliding the small handle under the toilet bowl sideways.
- Automatic Ventilator:** The ventilator automatically starts when the control panel is activated (by pressing the flush button) and will automatically shut off after approximately 5 minutes. The Automatic Ventilator Indicator will flash until automatic shut-off occurs. If you want to stop the ventilator, press the Automatic Ventilator button. If you want to re-start the ventilator, press the button again (the LED will start flashing again).
- Flush Water Tank Level Indicator** (only for toilets with own flush-water tank): When the Flush Water Tank Level Indicator lights up, refill the flush-water tank, as only about 1.5 litres of water is left in the tank, which is sufficient for approximately 2 flushes.

Emptying

The Waste Holding Tank has a capacity of 18 litres and requires emptying when the red light (LED) on the toilet control display lights up, when the Waste Holding Tank only has

capacity for approximately 2 more litres, which is no more than two to three further uses.

Make sure that the blade is closed. Open the access door located outside the vehicle, pull the safety catch upwards and remove the Waste Holding Tank.

- Place the Waste Holding Tank in an upright position (Pull-Out Handle at the top, Wheels at the bottom). Slide the handle sideways - to the front of the tank - until it snaps out of its locked position.
- Pull the handle up and wheel the Waste Holding Tank to an authorised waste disposal point.
- Push the handle back into its locked position. Turn the emptying spout upwards and remove the cap from the spout. Hold the Waste Holding Tank in such a way that during emptying you can operate the vent plunger with your thumb. To empty the tank without splashing, depress the vent plunger while emptying the tank. After emptying, rinse the tank and blade thoroughly with water.

WARNING: Do not seriously shake the tank or use high pressure water cleaners. This may cause damage to the tank's interior.

Note: The vent plunger should only be depressed once the emptying spout is pointing downwards. Prepare the toilet for re-use if required. Slide the Waste Holding Tank into the toilet and close the access door.

Emptying with Optional Features

- Waste Holding Tank Multi-Level Indicator:** The lower lamp indicates that the Waste Holding Tank is almost empty; the middle lamp indicates that it is more than half full; when the upper lamp lights up, the tank needs emptying as it can only take 2 - 3 further uses.

Note: The Waste Holding Tank Level Indicator will flash when the holding tank is not present. In this case the toilet will not flush.



20. **Waste Pump-Out System:** When activating the control panel this feature automatically lights up. When the Waste Holding Tank Level Indicator illuminates, press the Waste Pump-Out button to pump out the waste from the holding tank into the vehicle's waste tank. The button will flash while the waste is being pumped and will stop automatically (after approximately 5 minutes) when all waste has been transferred. If the vehicle's waste tank is full, the Waste Pump-Out light will flash rapidly and no pump-out will be possible until the central tank is emptied. (Check the level of the vehicle's waste tank on the vehicle's central console). After the Waste Holding Tank has been emptied, there will be approximately 1.5 litres of waste left in the tank. This is normal. Add 2 litres of water and a correct dosage of Thetford toilet fluids to the Waste Holding Tank.

CAUTION: It is vital that the correct amount of toilet fluid is added to ensure the proper breakdown of the waste in the holding tank. Only use the system when the tank is full. Using the system too often on an empty tank can cause damage to the pump, which could cause the system to fail.

Cleaning and Maintenance

The toilet should be cleaned and maintained regularly, depending on the amount of use. To clean Thetford toilets, we advise using water and Thetford Bathroom Cleaner.

Note: Never use bleach, vinegar or other powerful household cleaners that contain these substances. These may cause permanent damage to the seals and other toilet components.

Toilet Bowl

- Squirt Thetford Bathroom Cleaner into the toilet bowl.
- Flush the toilet bowl with water and wipe down the rest of the toilet with a damp cloth.
- Clean seat and lid The seat and lid can easily be removed: Lift the seat and lid assembly and pull the round pins (inside the assembly) outwards from the pin

holes. After cleaning, replace the seat and lid by positioning the round pins in front of the pin holes and push the lid and seat downwards.

- To keep your flush water fresh and to prevent deposits from forming in your toilet bowl, add a correct dosage of Aqua Rinse in your flush water tank, if present, on your toilet.

Tip! For a really shining toilet, dry with a soft dry cloth after cleaning.

Waste Holding Tank

To keep your Waste Holding Tank fresh and clean, Thetford has developed a number of different toilet fluids. Thetford toilet fluids suppress smells, reduce formation of gas, promote breakdown of toilet waste and increase the life span of a mobile toilet. We advise a thorough cleaning of the Waste Holding Tank once each season. Next to using Thetford's Cassette Tank Cleaner, the powerful cleaning agent for the periodical cleaning of the Waste Holding Tank of your toilet, we suggest the following: -

- Remove the removable mechanism from the Waste Holding Tank by turning it anti-clockwise and rinse it under a tap.
- Remove the cover plate from the Automatic Pressure Release Vent by prising it up using a small screwdriver. Use one hand to push the Automatic Pressure Release Vent open while holding the float of the Automatic Pressure Release Vent on the inside of the tank with the other hand. Push the float upwards, turn it 180 degrees and remove it from below. Remove the rubber seal underneath the float. Rinse the float and rubber seal under a tap. Replace the rubber seal and float for the Automatic Pressure Release Vent using the same method in reverse.

The rubber seals in the toilet (the lip seal, the mechanism seal, the automatic pressure release vent seal and the cap seal) should be regularly cleaned with water and treated with Thetford High Grade Seal Lubricant. This will ensure that the seals remain flexible and in good condition. If the toilet is not to be used



for any length of time, it is important to treat the seals with Thetford High Grade Seal Lubricant after cleaning.

Note: Never use Vaseline or any vegetable oil except olive oil. These may cause leakage or malfunction. The lip seal is a part of the toilet that is subject to wear. Depending upon the extent and manner of use, the seals will become less effective and will need replacing periodically.

Cleaning and Maintenance for Optional Features

- Automatic Ventilation: The filter of the Automatic Ventilation needs to be renewed periodically. After approximately 4 full weeks of use, the filter loses its absorption power.
- Pump-Out Waste System: To ensure optimal functionality of the Pump-Out Waste System, periodical maintenance of the tube and pump is recommended. After emptying the Waste Holding Tank completely, fill it with clean water and empty it again. This will clean the pump and the hose. Do this once every 3 weeks when on holiday. This should ensure proper operation of the system.

Winter operation

You can use your Thetford Cassette Toilet as normal in cold weather as long as the toilet is situated in a heated location. If there is a risk of freezing we advise that the toilet is drained by following the instructions under 'Storage'. For environmental reasons the use of antifreeze, such as that used in car radiators, is not recommended.

Storage

It is important that you follow the instructions below if you do not expect to use your Thetford toilet for a long (winter) period.

- Activate the Control Panel by pressing the flush button. Open the blade and press the flush button until water stops flowing into the bowl. Close the blade. Open the access door on the outside of your motorhome and empty the Waste Holding Tank at an authorised waste dump. Follow the instructions for cleaning

and maintenance. To allow the Waste Holding Tank to dry, do not place the cap back on the emptying spout of the tank.

21. If the toilet has its own flush-water tank, place a sufficiently large bowl under the drain tube to catch the remaining water from the flush-water tank and remove the drain plug. When no more water exits, put the drain plug on the drain tube, put it back in its original position and close the access door. If the toilet is connected to the vehicle's water tank, please follow your vehicle's instructions for draining the central water system. If your toilet is optionally featured with a Waste Pump-Out System, take out the Waste Holding Tank and completely clean it (see Cleaning and Maintenance). After cleaning, fill it with water, put it back and empty it via the waste pump-out system. Repeat this twice.

Toilet unit malfunctions

Contact your dealer or a Thetford Service Centre.

We advise draining the fresh water tank prior to travelling. Antifreeze should not be required if the motorhome is heated. If you do wish to use antifreeze, brands containing the following properties may be used in the fresh water tank:

- Ethylene glycol
- Mono-Ethylene glycol
- Propane-diol
- Glycerol
- Ethane-diol
- Glycol

Never use alcohol based antifreeze, i.e. Methanol, Ethanol, and Iso-propanol.



HOW TO USE YOUR MOTORHOME'S EQUIPMENT

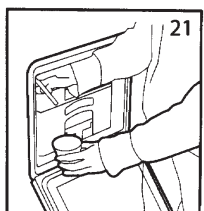
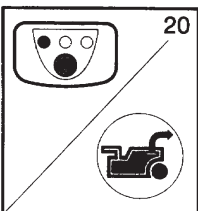
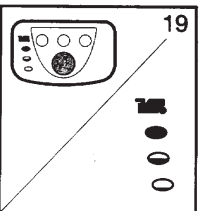
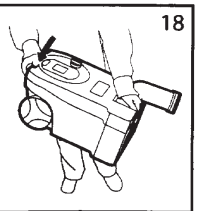
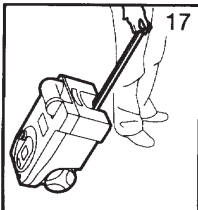
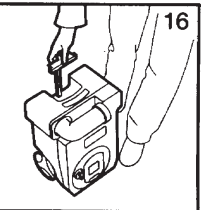
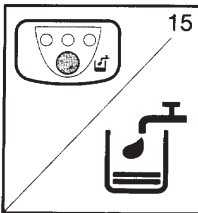
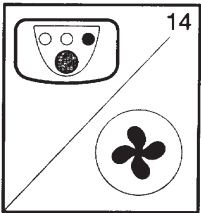
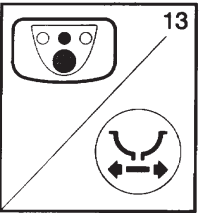
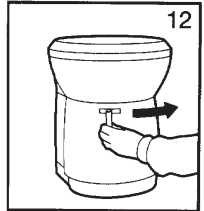
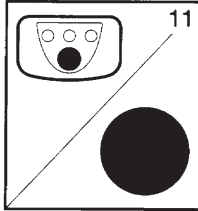
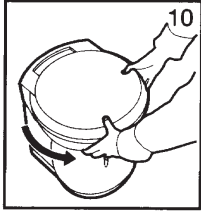
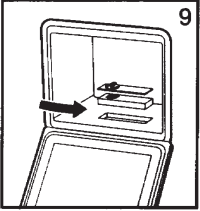
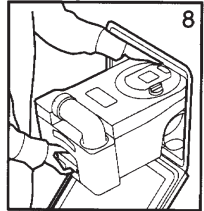
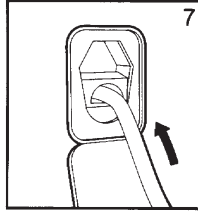
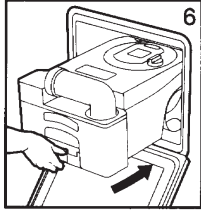
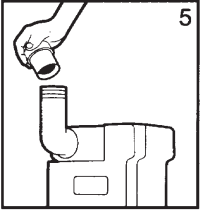
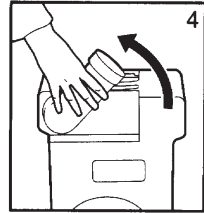
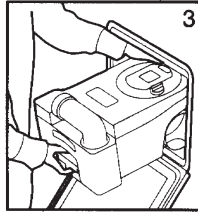
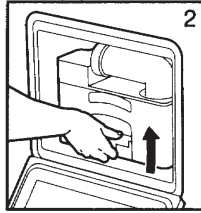
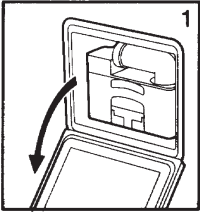



TELECO TV AERIAL

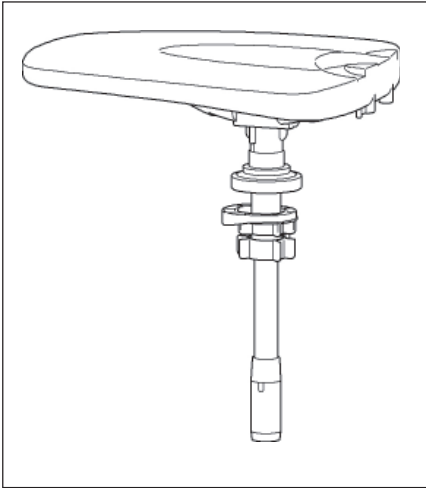

Connection to the Amplifier

Connect the lead exiting from the pole to the ANT input of the amplifier. Connect with the relevant lead, the TV connector of the amplifier with the television. Connect the amplifier to a 220V power socket or a battery, making sure you do not invert the + and - terminals (Fig 1).

OPERATING INSTRUCTIONS

- 1) Rotate the dB dial of the amplifier clockwise.
- 2) Tune the television to a channel available in the area where you are located.
- 3) Rotate and lift the antenna via the suitable pole until you get the best image on the TV.

Useful Tips

Not all the television signals you can receive in the zone where you are located will necessarily originate from the same direction. So if the quality of a programme image is poor, try rotating the antenna as the signal may be coming from a direction different from the others.

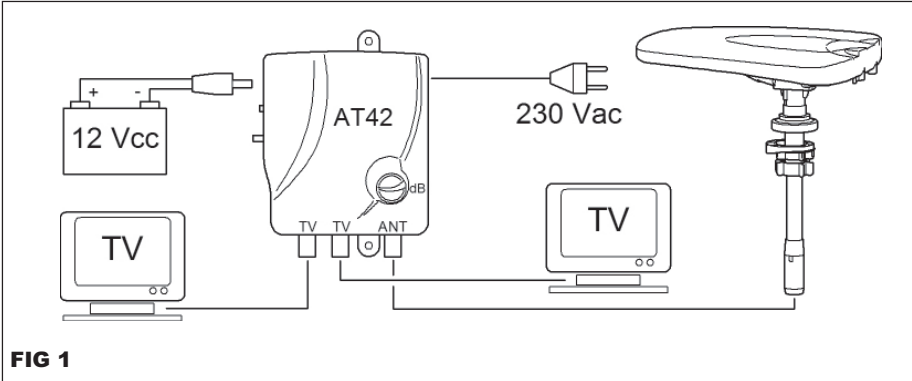

FIG 1

Gain Adjustment

With the dB dial turned all the way clockwise, amplifier sensitivity will be at maximum and it is therefore able to receive the weakest signals. If, instead, the signals are very strong, there may be image overlap on the TV screen. In this case rotate the dB dial anticlockwise slowly until the image is perfect.

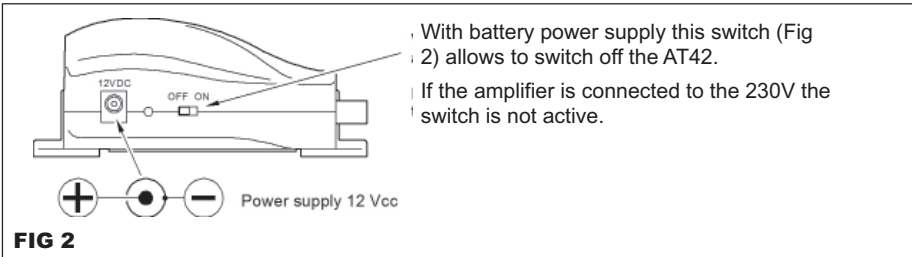
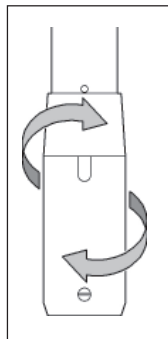

FIG 2

Instructions for the Reception of Horizontal or Vertical Polarity Signals

This antenna can be positioned both horizontally and vertically by simply turning the knob at the bottom of the mast.

By turning the knob fully left-hand, the antenna shifts to the horizontal position, by turning it right-hand the antenna shifts to the vertical position.





HOW TO MAKE UP YOUR BEDS

ACCORDO 105

The front double bed in the 105 is made up by lifting the two side beds up and pulling them together to meet in the centre.

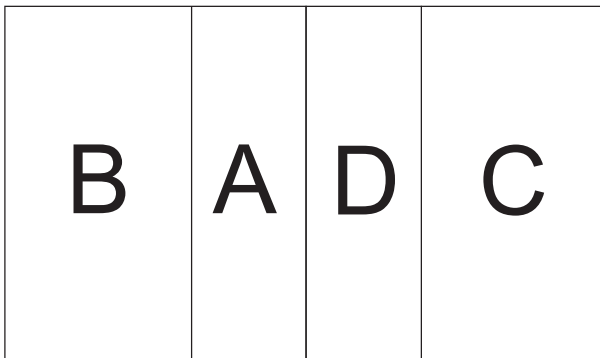
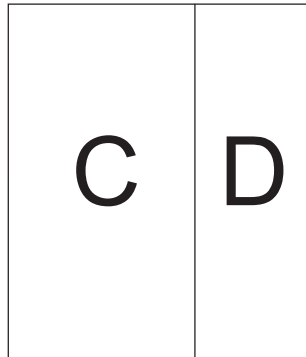
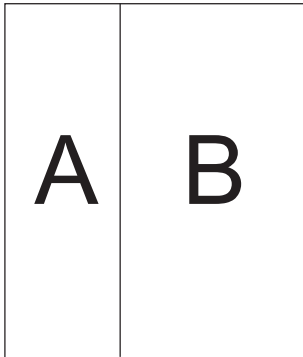



HOW TO MAKE UP YOUR BEDS

ACCORDO 125 - 135 (FRONT BED MAKE UP)

- Cushions
- A base cushion
 - B Back rest (Not needed for the bed)
 - C Make up cushion supplied
 - D Front passenger seat
 - E Bolster cushion supplied
 - F Memory foam mattress which sits over all the cushions

Please note: The driver's seat should be rotated so that its back rest is facing the driver's door and then slide the set base as far towards the driver's door as possible. This should prevent the seat from rotating while the bed is in use.

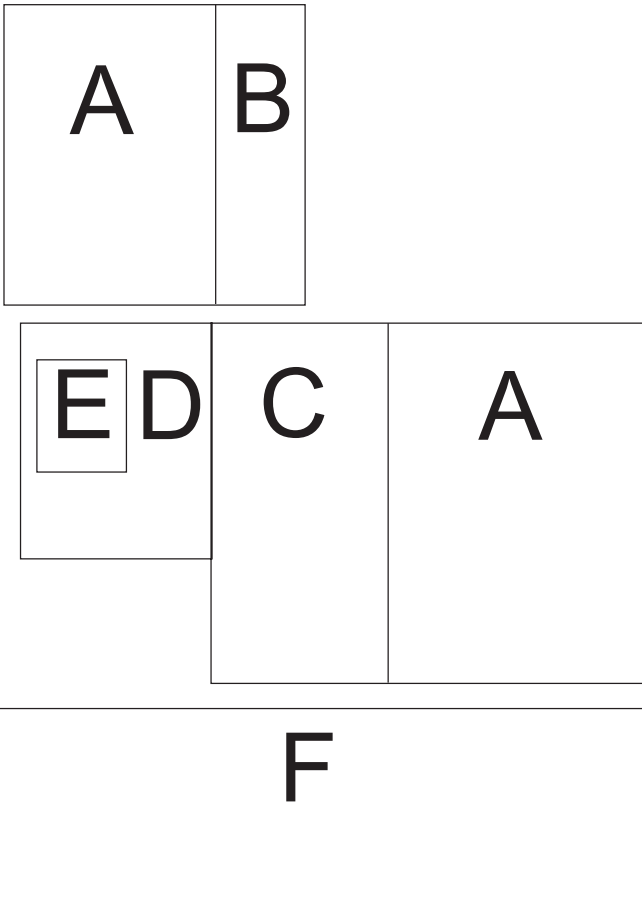



SECURITY

Theft deterrent, prevention and security of your motorhome is taken very seriously at Elddis. That is why we have provided a combination of standard features and optional extras designed to deter and prevent thieves from stealing your property. And in the unlikely event that they should succeed, aid the identification, speedy recovery of your property and assist in the prosecution of the thief.

Tracker (Option)

Your motorhome can be fitted with an optional TRACKER.

Your dealer will already have registered the motorhome with TRACKER and confirmation sent to you via email.

If it has not been registered you can easily do it yourself.

Open the TRACKER registration portal

www.tracker.co.uk/elddis

Enter TRACKER VLU and Motorhome VIN

Numbers are matched and confirmed with the vehicle model

Enter Dealership name from dropdown menu

Enter customer details including email address

Confirmation sent to customer email

One year subscription will begin

TRACKER will contact customer towards the end of the one year subscription period with the options available.

or call TRACKER directly on 0870 606 1269

Motorhome Theft

The theft of a motorhome can occur in the most unlikely circumstances; from a motorway service area, even from an owner's driveway. Secure all windows and doors when your motorhome is unoccupied, even if only for a short length of time.



CARE OF YOUR MOTORHOME

This section of the guide is devoted to the care, cleaning and general preservation of your motorhome in order to retain its showroom condition.

Exterior Body Shell

The exterior painted body shell of your motorhome, usually the side walls, is acrylic finished aluminium, which is extremely durable and easy to clean. It is recommended you first wash off any caked dirt and mud with cold water then use a proprietary brand wash and wax shampoo and rinse with plenty of cold water.

CAUTION: Under no circumstances should an abrasive or harsh cleaner be used. Do not use a pressure washer as this can disturb mastic seals.

Glass Fibre Reinforced Plastic (GRP)

GRP components need to be washed, waxed and taken care of like a car. Chemicals and dirt can collect during storage, and the gel coat can be stained or marked when chemicals combine with rain or dew. Most stains or marks can be removed with mild dishwashing detergent, but more stubborn marks may require a (fine grit) rubbing compound such as T-cut. To help keep your GRP components looking almost like new, it is wise to wash the parts monthly (or more frequently) using mild dishwashing detergent, but avoid using strong alkaline (e.g. trisodium phosphate) or acidic cleaners or abrasives. Waxing the components once or twice a year with a good grade paste wax will help to maintain the colour and finish.

Acrylic Windows

Your motorhome is fitted with shatter resistant acrylic windows. To preserve their clarity and unblemished transparency it is essential that the following cleaning instructions are strictly adhered to: Road grit, dust, sand, flies, lime tree secretions, bird droppings etc., should be washed off using plenty of cold water do not use a sponge to clean off heavy dirt deposits. Any remaining dirt should be washed off using a soft cloth and warm water. Under NO circumstances

should any abrasive cleaning agents, household detergents or proprietary cleaning fluids be used. Wash the window again using only cold water and dry off with chamois leather.

Please note: Should scratches appear on the acrylic windows these can often be removed with an acrylic polish. E.g. ICI Perspex polish. Gentle polishing with a liquid metal polish, i.e. Brasso may also have the desired effect - consult your retailer BEFORE attempting to remove any but the slightest scratch.

Window Blinds & Flyscreens

To clean the blinds and flyscreens, moisten a soft cloth or sponge with a small amount of water and mild soap suds and gently wipe dirt off. Allow to dry before retracting, failure to do this could result in mildew forming.

ABS - Wheel Spats & Panels

To preserve the appearance of all ABS panels and fittings road grit, dust, sand, flies, lime tree secretions, bird droppings etc., should be washed off using plenty of cold water. Any remaining dirt should be washed off using a soft cloth and warm water. Under NO circumstances should any abrasive cleaning agents, household detergents or proprietary cleaning fluids be used. Wash the ABS material again using only cold water and dry off.

Interior Walls

Your motorhome interior walls will only require a wipe over with a damp cloth, using a mild detergent, to keep them in a 'showroom' condition.

Furniture

Treat your motorhome furniture as you would the furniture in your home. Polish wood surfaces sparingly with a good quality wax or spray polish. Use a damp cloth to clean Melanate laminated surfaces.

Carpets, Upholstery And Curtains

Vacuum clean carpets and upholstery to ensure a long life, marks on cushions can be removed using a mild upholstery shampoo with the minimum of water. Curtains should be dry cleaned only.



Washroom And Handbasin Fittings

These should be cleaned using a non abrasive household cleaner. Always put the cold water into the hand basin before adding the hot in order to preserve the finish of the thermoplastic formed basin.

Please note: Under no circumstances should alcohol, spirit or solvent-based liquids be used on GRP or ABS plastic panels as these substances may react with the material and cause visible damage.

Shower Trays

Only clean your shower tray using soap and water. Do not use chemical based cleaning agents as this may attack the material of the tray.

Water Systems

The water systems and in particular storage tanks, in motorhomes are susceptible to contamination by bacteria if care is not taken with their use and cleaning. The symptoms caused by bacterial contamination are not purely limited to gastro-intestinal diseases, but may also manifest themselves as ear, nose, throat, and eye or skin infections. It is therefore important that you carry out the following procedure prior to using the motorhome each time, even if you boil or filter all water you use for drinking.

Please note: If your motorhome is not going to be used for an extended period of time it is recommend that you disconnect the vehicle battery to prevent the battery from discharging.

Water Containers

- (i) All water remaining in any water container should be disposed of so that the container is empty.
- (ii) The outside of external water containers should be thoroughly cleansed and washed down to remove any dirt, dust or other contaminant. Water at a suitably hot temperature containing an appropriate detergent is recommended for this purpose. Water should then be put into the container, swirled round and then emptied out.
- (iii) All containers should then be totally filled with water containing an

appropriate disinfectant / sterilising solution and allowed to stand for the recommended contact time (e.g. Milton for 15 minutes).

- (iv) The solution should be emptied from the container.
- (v) The opening of the any container should be cleaned thoroughly with an appropriate pre-prepared wipe impregnated with a disinfectant / sterilising solution.
- (vi) External containers should be inverted whilst stored overnight (if possible).
- (vii) Containers must be filled with mains water only and mains water only should be used for the above cleaning procedure.
- (viii) On no account should garden hoses be used to fill water tanks.

Internal Water Systems

- (i) Drain down the system. (Open all taps to allow air in, enabling the system to drain quickly). See Index - Draining Down The Water System.
- (ii) Remove any water filters fitted, and replace with a short length of hose or empty filter cartridge (this will ensure the filter is not affected by the disinfectant / sterilising solution).
- (iii) Fill the system by using the pump with a disinfectant / sterilising solution. (Check that the solution at full strength appears at all taps/showers). Allow to stand for the recommended period of time.
- (iv) Drain the system down completely.
- (v) Thoroughly clean the outside of all taps/connectors with a cloth soaked in the disinfectant / sterilising solution.
- (vi) Flush the system through with clean drinking water until no traces of disinfectant / sterilising solution can be detected at any tap.
- (vii) Replace the filter. Suitable sterilising chemicals are available from your Elddis Retailer, accessory shop, chemists, or homebrew shops. It is not, however, recommended to use bleach or sodium metabisulphide.



Thetford Toilet

WARNINGS

Cold Weather Use - To prevent freezing during cold weather use, add antifreeze to the toilet system fresh water tank. Use a non-toxic (propylene glycol) type of antifreeze. Refer to chart on container to obtain level of protection.

Warmer Weather Use - In warmer weather or longer intervals between emptying the waste tank you may require additional toilet fluid. Use only Thetford toilet fluid to achieve the best results.

WARNING: Ensure the wheel is of the same construction and size as the one that has been removed.

CAUTIONS

- Never add toilet fluid directly into toilet bowl.
- Do not use strong household detergents or cleaners that contain chlorine, solvents or acid contents.
- High Altitude and Hot Weather Use - with large temperature differences and changing heights during driving, pressure can start to build up in the waste holding tank, causing contents to splash upward upon opening the valve blade if opened too fast.

Changing A Wheel

- (i) Ensure handbrake is applied and chock the wheel diagonally opposite the wheel to be removed.
- (ii) Remove the hub cap. (If applicable)
- (iii) Use wheel brace to slacken off wheel nuts on the wheel to be changed.
- (iv) Position jack at the appropriate jacking point (see Peugeot vehicle handbook).
- (v) Jack up the motorhome until the wheel for removal is just off the ground.
- (vi) Remove the wheel nuts and remove the wheel.
- (vii) Fit spare wheel and reverse the above procedure.
- (viii) Tighten wheel nuts in accordance with the Peugeot handbook instructions.



PRE-SEASON WATER SYSTEM PREPARATION

Over the winter months bacteria can grow in your water system. Particles of minerals and dirt gather in joins and any undrained areas. After following this guide, change your water filter. If you have a Whale AquaSmart system, change your Whale WF3000 Water Filter. If you have an in line filter in your plumbing system, Whale recommend you use WF1230 Aquasource Water Filter.

To check the system hasn't suffered any frost damage over the winter and floods your van, take the following precautions:

- Close all drain valves in your van's water system.
- Re-attach your shower head.
- Ensure all taps and showers are positioned over sinks and drains.
- Check condition of leisure battery, if it is below 12V please connect to mains electricity supply.
- Rinse out fresh and waste water tanks with water, add a non-caustic cleaning and purifying agent.
- Completely fill your fresh water tank with tap water.
- Leave the hot tap that is furthest away from the water heater fully open, close all remaining taps and showers.
- Turn on isolation switch for water pump, normally found on the control panel or in a menu within the control panel's software.
- You should hear the pump running or the pressure coming from the open hot tap.
- Water will pop and splash as it comes from the hot tap, it will take some time for a flow of water to arrive as the water heater needs to fill up first.
- Once an even flow is achieved, work back towards the water heater, opening the next further away hot tap until all have been opened and there is a smooth water flow.
- The next stage is to close all hot water taps and open the cold water taps in the same order as the hot taps, beginning at the furthest away cold tap.
- When an even flow is achieved through all the taps in your van close all the taps. The pump should turn off (after a few seconds if it is a pressurised system).
- Remain in your van after the pump has stopped and inspect all the taps and shower heads for leaks. You may need to dry them down first to spot any leaks). If there is access to the underside of the taps check for water leaks.

If you find a water leak, check the following:

- If there is a water leak coming from the connections on the underside of the tap, try to push them home or tighten them with a spanner depending on the connections.
- If the leak originates from a crack or an unknown source check the rest of the taps and showers before turning off the water pump.
- Then drain the water system as the water pressure will continue to escape through the leak and will cause water damage to your van. Contact your local dealer to rectify the leak(s).

(Note: While checking the taps and showers you may hear the pump turn on and off a few times. If you hear this, turn on and off all the taps for 10 seconds individually to remove any trapped air from the system.)

- If the pump continues to run intermittently for short bursts this can indicate a leak as pressure is being lost. Follow all the water pipes and check if there is any water leaking from joints or if a pipe is burst.
- Should you find a leak at a joint, tighten the joint or push the pipe fully into the Quicklift fitting to dry up the water and wait to see if the problem persists.
- If you find a burst pipe or damaged tap/shower we recommend that you contact your nearest Motorhome dealer.
- After the cleaning agent has remained in the system for the required time, purge the system by running 2 or 3 full tanks of water through the system using all taps and showers in the mixed position.
- Change your filter.
- Finally your system is ready for use.

If you have successfully carried out this guide, please check your water heater is functioning correctly, to do this please follow the manufacturer's instructions.

Enjoy the new season.



GETTING READY FOR THE WINTER

Before following this guide, ideally carry out this procedure prior to moving the motorhome to its winter storage location. (The movement of the vehicle will encourage residual water to drain from the system).

Ensuring that all water is removed from the motorhome's pipework, taps and appliances will reduce the risk of frost damage occurring. Frost damage can occur when water left in the system freezes and expands, causing pipework and appliances to split, crack or burst.

- Ideally position motorhome so the drain valves are at the lowest point i.e. tilt the motorhome or park on a slope.
- Turn the pump off.

User Tip: If mains electric hook up is available and a Whale Space Heater is fitted select 500w electric () and set temperature to frost protection.

- Open all taps/mixers in the mid position, including the external shower (if fitted).

User Tip: Fully drain/empty holding tank and flush tank of toilet in accordance with the manufacturer's instructions.

- Remove shower handset (including the external shower, if fitted) and shake water out.
- Open water heater drain valve and leave open.

User Tip: Ensure the gas is turned off at the bottle.

- Open on board tank drain valve (if present) and leave open.
- Where grey waste tanks are fitted, remove all sink plugs and open the drain tap.

User Tip: Do not close the fridge door tightly, leave ajar to prevent mildew forming.

- Open any other drain points (if present).

User Tip: To maintain the battery periodically charge throughout the winter.

- External water components - shake water out of pump/Aqua Source/Aquasmart filter assembly and store inside the van.
- Internal pump - turn on and allow to run to expel additional water for 2 minutes.
- If internal pump is accessible disconnect outlet pipe and turn on pump to purge water into an aequate basin. Only reconnect pump when water system is to be used.

Please note : Where 'wet' heating systems are fitted, please refer to the manufacturer's instructions for winterising. These winterising tips are intended as a general guide only. For servicing and product advice for your specific vehicle, please contact:

Whale Customer Support:

Tel: +44 (0)28 9127 0531

Fax: +44 (0)28 9146 6421

Email: info@whalepumps.com

www.whalepumps.com



STORAGE

LONG TERM & WINTER STORAGE

If your motorhome is to be stored for any length of time, especially over the winter period, the following operations are recommended:

- (i) Remove all linens, blankets, cushions, clothes, mattresses, etc. that could be affected by damp conditions
- (ii) Clean the motorhome inside and out as detailed in the previous section.
- (iii) Drain the water system (see index).
- (iv) Ensure all windows, roof lights and doors are correctly fastened. Check fixed ventilation apertures are not obstructed.
- (v) Check that the site you have chosen to store the motorhome is open, fairly high and dry and if possible not exposed to gales etc. If this proves impossible it is recommended that the motorhome chassis is anchored to the ground.
- (vi) Jack up the motorhome (use bottle or screw jack), so that the wheels are clear of the ground. Support the motorhome axle with wooden blocks, axle stands or similar so that when the jacks are removed the wheels remain clear of the ground. Cover the tyres to prevent deterioration.
- (vii) Release the handbrake.
- (viii) Removing the wheels reduces the risk of motorhome theft.

Motorhome Covers

Covers may be used to protect your new Elddis motorhome provided that the cover used is of a breathable type. Ensure that any sharp objects are removed e.g. the point of a status omni-directional aerial, and that the cover is well tied down. Your motorhome must be ventilated every 4 to 6 weeks if it is to be stored with a cover in place.

Power Drain

In order to reduce any drain on your Leisure Battery while your motorhome is being stored you should ensure that the main control switch on the refrigerator is set to the 0 position

Please note: If you have the Elddis Protect alarm fitted and you disconnect the leisure battery the alarm will run off the back-up battery for approximately 2 weeks.

Should the motorhome be stored for a prolonged period of time it is strongly recommended that the motorhome is fully serviced before the commencement of use. Your retailer will ensure that your motorhome is safe, secure and ready for your enjoyment.

We recommend that in order to prolong the life of your leisure battery it is disconnected while your Motorhome is in storage.



MOTORHOME WARRANTY COVER

Introduction

At Elddis we are confident that our new motorhomes are engineered using the latest manufacturing techniques and advanced materials technology ensuring that, when buying one of our products, you are buying the very best. We extend this philosophy to our customers by offering long term peace of mind and reassurance through our extensive warranty cover.

Your warranty cover commences on the day your new motorhome is purchased and comprises two key elements:

1. Three year manufacturer's warranty
2. Ten year body integrity warranty

Scope

This applies to all new Elddis products manufactured from 2012 model year onwards.

Three year manufacturer's warranty

Year 1 warranty - Covers all original components, including permanently fitted equipment forming part of the original product specification.

Year 2 and 3 warranty – Covers all original components, including permanently fitted equipment forming part of the original product specification, with the exception of the following items:

- Microwave
- TV
- Tyres
- Batteries
- Windows and glass
- Deterioration of exterior paint work
- Soft furnishings, carpets and floor coverings
- Entertainment equipment
- Fluorescent tubes, bulbs, LEDs and fuses
- Plastic and GRP exterior panels
- Plastic products including A-frame covers, wheel spats and shower trays
- Minor adjustment of blinds, hinges, catches, stays and doors
- Exterior decals

Ten year body integrity warranty

Elddis products are covered against water ingress damage for 10 years from the original date of purchase of a new product (6 years for subsequent owners from the 1st owners original date of purchase). This applies to water ingress through any permanently sealed seam joints.

In order to comply with the terms of the above cover the following conditions must be met:

Reporting a fault

In the unlikely event that you experience a problem with your motorhome please contact your retailer.

It is with the retailer that your contract of sale exists and consequently they have the responsibility to ensure any complaints and warranty issues are addressed. Any Elddis Approved / Service Centre, NCC Approved Workshop or NCC equivalent standard as set out in this handbook may carry out work at their convenience or discretion, but are not obliged to do so.

All Elddis products are classed as portable and therefore all work under warranty requires the motorhome to be delivered and collected from the selling retailer.

The cost of transporting the motorhome by any means to and from the place of repair is the responsibility of the owner.

Conditions attached to the warranty cover

All warranty work must be undertaken by a current Elddis Approved / Service Centre, NCC Approved Workshop or NCC equivalent standard as set out in this handbook.

- You must retain the original sale invoice for the motorhome.
- All new motorhomes must be registered with Elddis within 6 weeks of purchase as new. Your retailer can forward this information to us. Please keep us informed of any name or address changes by using the Notification of Change to Name and Address form.
- The motorhome must have an annual service and damp check carried out by an Elddis Approved / Service Centre, NCC Approved Workshop or NCC equivalent



standard as set out in this handbook. Original invoices and damp reports must be retained as proof that the annual services have been carried out in accordance with our warranty terms.

- **Service intervals:**
 - a) In years 1, 2, and 4 through to 9 the service must be completed no more than 60 days either side of the anniversary of the date of purchase.
 - b) In Years 3 and 10 the service must be completed no more than 60 days before the anniversary of the date of purchase.
 - c) For second owners the service in years 3 and 6 must be completed no more than 60 days on or before the anniversary of the original date of purchase.
 - d) No service interval should exceed 14 months.
- e) **Failure to service the vehicle within the specified time limits will invalidate your warranty.**
- Where an annual service identifies that repairs are necessary the motorhome must be made available for repair within six weeks of the date of inspection for the purpose of carrying out the repair work. Elddis reserves the right to inspect the vehicle before work commences.
- Work may only be undertaken by an Elddis Approved / Service Centre, NCC Approved Workshop or NCC equivalent standard as set out in this handbook and only after approval by Elddis (depending upon individual circumstances).
- Elddis will pay the costs of remedial work to the repairer, only after approved work has been carried out. The cost of transporting, towing or moving the motorhome by any means to or from the place of repair is the responsibility of the owner.
- The Policy is not retrospective and is applicable to 2012 model year motorhomes onwards.
- No liability will be accepted for any

consequential loss, damage, costs, expenses or other claims for compensation arising which were not reasonably foreseeable by both parties when the motorhome was originally purchased.

- No liability will be accepted for damage caused by fair wear and tear, rodent damage, willful damage, negligence or abnormal working conditions.
- No alteration may be made to the original construction.
- In the case of a dispute Elddis will appoint an independent arbitrator. Elddis will pay for the costs of arbitration, subject to the owner paying a £250 deposit.
- If the arbitrator finds in favour of the customer, then the deposit will be returned. If the arbitrator finds in favour of Elddis, the customer will lose their deposit.
- Where the arbitrator awards a sum of money less than an offer made by Elddis which has already been rejected by the customer, then their deposit is forfeited.
- In all cases the arbitrator's decision is final and both parties must agree to abide by the decision.

Exclusions

Warranty cover is not given for motorhomes if they have been used under any of the following circumstances:

- Used for hire.
- Used as a permanent residence
- Towed behind a commercial vehicle
- Used for racing or time trials
- Damage resulting from freezing, accident or fire damage

Mains electrics

It is recommended that you have your mains electrics system inspected by a NICEIC approved contractor every 3 years.



Transfer of ownership

If you purchase this vehicle as a used vehicle it may be possible to transfer the unexpired term of the warranty cover (up to a maximum of six years commencing at the original date of purchase from new). The warranty cover for a used vehicle commences from the original date of purchase from new and is as follows:

1. Three year manufacturer's warranty
2. A maximum of six years' body integrity warranty

The warranty is subject to the usual terms and conditions' set out in the handbook and is only transferable on payment of a £50 administration fee. Full documentary evidence that the motorhome has been serviced annually should be provided at the time of transfer, in accordance with the terms and conditions of the warranty stated in the handbook. Transfer of ownership must be completed within three months of change of legal ownership. Please complete the Notification of Change of Ownership form in your handbook.

This warranty does not affect the purchaser's statutory rights. The warranty shall be governed and construed in accordance with the laws of England and the parties irrevocably submit to the exclusive jurisdiction of the courts of England.

For second owners the service in years 3 and 6 must be completed no more than 60 days on or before the anniversary of the original date of purchase.

Non Warranty Repairs

Should you require any replacement parts for your motorhome it is necessary that you contact the Retailer from whom you purchased the motorhome or any Elddis approved Retailer and give the following information, which will help in identifying the required component:

- (i) Model and make of motorhome
- (ii) VIN number
- (iii) Description of required part
- (iv) Photograph, size or diagram of required part

Please note: All parts must be ordered and supplied through an approved retailer.

Remedial Work

Elddis, together with its suppliers is continually undertaking extensive research into testing, remedial work procedures and materials such as sealants, adhesives, gaskets and tapes. Therefore, if for any reason your new motorhome is damaged or requires remedial work then only an approved Elddis Retailer or Service Centre should undertake such work.

All such work should be undertaken using only approved Elddis genuine parts, recommended sealant and following Elddis procedures. Elddis will also undertake to supply certain specialist repairers with the necessary spare parts. In this case, your selected repairer must contact the PARTS DEPARTMENT with all enquiries.



MOTORHOME CONSTRUCTION - MAIN COMPONENTS

The following is a brief description of the main components used in your motorhome. More comprehensive descriptions can be found in the equipment manufacturers literature held in the Owner's Information Pack.

SOLID CONSTRUCTION BODY SHELL

Elddis Motorhome Bodies are constructed from the highest quality materials. The fully insulated floor is a constructed timber frame with plywood internal floor and a GRP underskin for added water resistance and insulation laminated together for strength. The walls comprise an insulated foam sandwich having pre-coated aluminium exterior surface and vinyl coated plywood internal finish. Wooded framing is positioned within the sandwich to add strength. The latest technology is used to produce the extremely well insulated and robust, yet lightweight sections.

WINDOWS

Windows are all of a double glazed acrylic construction and the door frames are extruded aluminium.

INSULATION

Elddis motorhomes are built to thermal insulation Grade 3 in accordance with European Standard BSEN 1464 part 1.



EQUIPMENT LIST

ACCORDO

REFRIGERATOR	DOMETIC RM8400
HEATER	WHALE SPACE HEATER
WATER HEATER	WHALE 8LTR
SINK AND DRAINER	THETFORD SPINFLO ARGENT CENTRE SINK
OVEN	THETFORD SPINFLO DUPLEX
HOB	THETFORD SPINFLO 3 BURNER HOB
TAPS KITCHEN	CARAFIO MIXER SINGLE BAR
TAPS SHOWER	CARAFIO SHOWER MIXER SINGLE BAR
TAPS VANITY	SPACE SAVER MIXER
LIGHTS RECESSED LED	BCA LED RECESSED
12V READING LIGHTS	BCA EYEBALL HALOGEN
CONTROL PANELS	BCA BLACK
ELECTRICAL FITTINGS	BCA C LINE
TOILET	THETFORD ROTATABLE C260S



ELECTRICAL DRAWINGS

ACCORDO

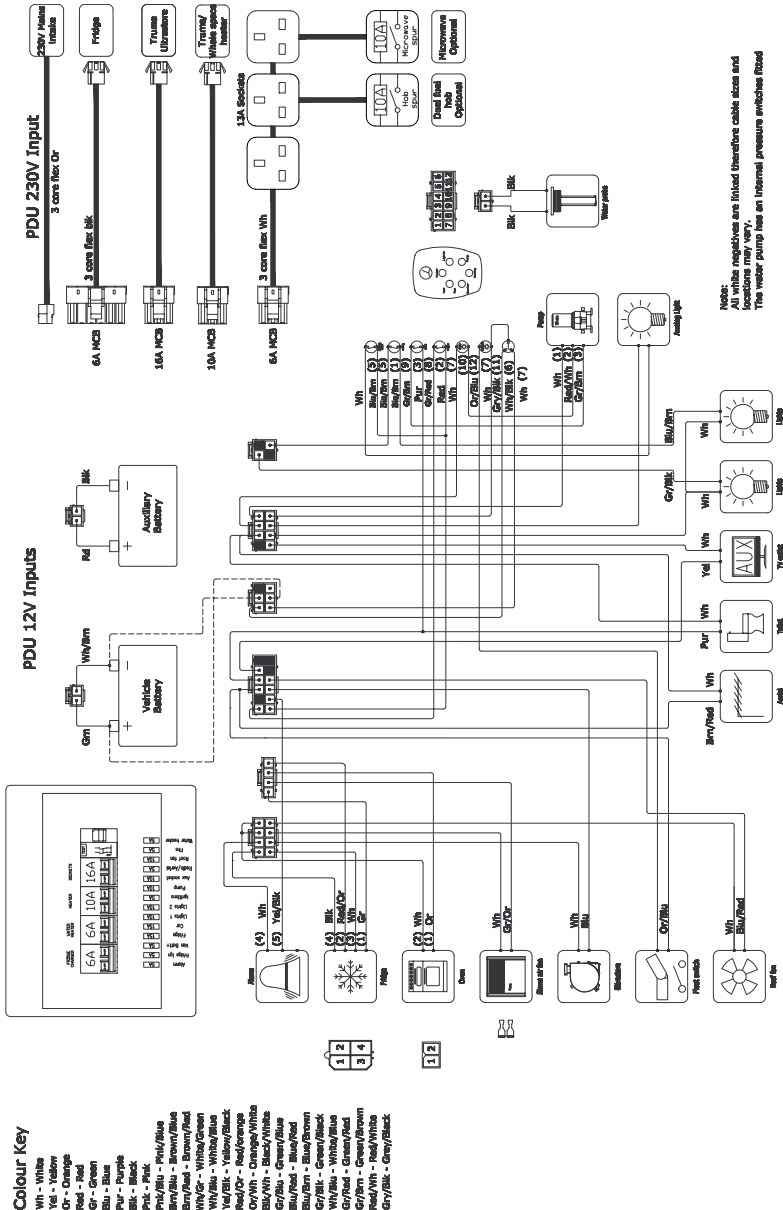



GENERAL QUESTIONS

Q: Where Can I Obtain Your Latest Brochure?

A: Our latest brochures are available from Approved Retailers or can be viewed and printed from the **download** section on our website www.elddis.co.uk. A request form can also be completed should you wish to receive a printed copy of our latest brochures.

Q: Why Is the Handbook Not Specific To My Model?

A: Many of the components used in the manufacture of our motorhomes are identical throughout our model ranges, so we produce a generic handbook, which covers all models manufactured for that season. If the literature supplied with your motorhome does not answer your question then please contact your Retailer for further assistance.

Q. I Require Technical Or Other Information, Who Can Help Me?

A. The majority of information you require is available through your Elddis Retailer.

Q - Can You Tell Me The Second Hand Price Of My Motorhome?

A - As a manufacturer we are not involved in the second hand market. You should contact a Retailer. They should be able to give some indication of market value.

Q: Can I Fit A Bicycle Rack/Top Box/Air Conditioning To My motorhome?

A: It may be possible to fit accessories to your motorhome but this will depend upon the internal construction of the roof/walls and whether they can support the weight of the accessory. If it is possible your Retailer will be able to advise you, (or alternatively they will obtain confirmation and a drawing where necessary, from Elddis). Please note that weight of any accessories will reduce your User Payload allowance.

Q: My Interior Lights Are Not Working, What Do I Do?

A: It is possible that all of the 230V mains electrical equipment may not be operated simultaneously. Check fuses, battery connections and power supply (master light switch). Refer to your Retailer for further assistance.

PLEASE NOTE: The internal lights in your motorhome will not operate whilst the motorhome engine is running.

Q: Where Can I Get Spare Parts For My Motorhome?

A: Retailers will be able to source most parts you require. For details of your nearest Elddis Retailer please refer to our Find A Retailer section on our website, or call 0871 964 2113 for assistance.

Q. How Many Years Will Spare Parts Be Available For My Motorhome?

A. Elddis will endeavour to supply spare parts for a motorhome, for at least 8 years from new.

Q. Why Don't You Stock Parts At The Elddis Factory?

A. Due to the volume of models we produce it is not possible for us to maintain stock levels of every individual component used in our manufacturing process. We do stock commonly requested items, but some items must be made to order

Q. What If The Parts Are No Longer Available?

A. Where an original part is no longer available, whenever possible we will suggest a suitable alternative if it is available.

Q: Who Can Service My Motorhome?

A: Your supplying Retailer is obliged to undertake your warranty work. However, any Elddis Approved / Service Centre, NCC Approved Workshop or NCC equivalent standard as set out in this handbook can undertake the work, but this is at their discretion. We will also accept services completed by a NCC approved company, but they will not be able to undertake warranty work if they are not approved by Elddis

Q. I Am Having Trouble Booking My Motorhome in For Its Service, In Line With The Requirements. What Timescale Is Acceptable?

A. Please refer to the warranty section for the terms and conditions of servicing. We would recommend that you plan your services in advance in order to meet the requirements.



Q. I Have A Problem With My motorhome, Who Can Help Me?

A. We would always recommend that you contact your supplying Retailer. Your local Elddis Retailer or Elddis Approved Service Centre may be able to assist. An inspection can then take place and the necessary course of action agreed.

Q. I Am Unhappy With The Service I Have Received From My Retailer/Service Centre, Where Do I Go From Here?

A. We would recommend that you write to your Retailer/Service Centre, detailing your problems and requirements, requesting a response explaining how they will resolve your complaint. A copy of your letter can also be forwarded to Elddis Customer Care Department, quoting the serial number of your motorhome and the name of the Retailer/Service Centre. Please be assured that we will assist your Retailer/Service Centre in resolving any problems.



GLOSSARY

ABS - plastic

Acrylonitrile Butadiene Styrene Plastic the material used for most of the large plastic components within your motorhome.

Actual Laden Weight

This is the total weight of the motorhome when loaded ready for use by the end user.

Aquaroll

Brand name used generically for a water container that rolls so you don't need to lift it.

Battery Charger

This is required to keep a leisure battery charged. Most motorhomes include a charging facility that operates via the mains hook-up, and also has the ability to recharge from the tow car's alternator while travelling.

Berth(s)

Sleeping place - Refers to the number of people a motorhome can accommodate for sleeping.

Blown Air Heating

A method of heating the living quarters of a motorhome by use of a fan pushing air out through a number of outlets.

Bunk Bed

This is a sleeping place, usually higher up than a conventional bed. Often (but not always) this can be folded or removed to provide additional living space.

Butane

Is a form of Liquefied Petroleum Gas (LPG) that normally comes in blue cylinders. This type of gas is most commonly used in the UK, although a switch to propane is advised in severely cold weather conditions.

Campingaz

This is the trade name of Butane gas.

Cassette Blind

This is a roller blind that is fitted as part of the window assembly, often along with a flyscreen, thus giving a neat installation.

Cassette Toilet

A form of chemical toilet found in modern motorhomes, where the waste holding tank can be accessed and emptied from outside.

Control Panel

Used as the description for the panel of electrical switches and gauges governing 12V and mains electricity systems.

Dinette

This is a popular style of seating arrangement where two seats or settees face each other across a table.

Earth Leakage Circuit Breaker (ELCB)

ELCB Earth leakage circuit breaker - see residual current device (RCD)

End Kitchen

A common term used to describe floor plans that put the kitchen across the rear, usually adjacent to a motorhome door on one side and washroom on the other.

Essential Habitation Equipment

Those items and fluids required for the safe and proper functioning of the equipment for habitation as defined by the manufacturer of the motorhome. This includes items such as the leisure battery and gas cylinders, plus water contained in the water heater etc.

Flyscreens

Mesh fittings for windows doors and roof vents, to keep out insects etc.

Free-Standing Table

This is a table that, because of its leg design, can be used inside or outside.

Full Service Pitch

This is a pitch that has individual provision for fresh water supply and waste water disposal, in addition to mains electricity and in some cases TV aerial connection.

Gas Cylinder

This is a portable, pressurised container for the storage of LPG.

Gas Cylinder Locker

Is the compartment on the motorhome for the storage of gas cylinders.

Gas Drop out Holes

These are not part of the ventilation. LPG is heavier than air, so holes through the floor below gaspowered appliances allow any leakage of gas to exit the habitation area.



Grey Water

This is the waste water from sink/shower.

Gross Vehicle Weight (GVW)

This is the weight of the vehicle laden to its maximum, as defined by the manufacturer. See also MTPLM.

GRP

Is Glass-reinforced plastic, but more commonly known as glass fibre (not fibre glass, which is a trade name)

Handbook

This is an owner's manual, a guide to the workings of your motorhome.

Hardstanding

This is a pitch which has a hard surface made of gravel, asphalt, concrete etc, instead of grass.

Hook-Up

This is a facility on a pitch for connection to mains electricity.

Ingress

Usually meaning water ingress, a possible problem where water seeps in at the joins, usually as a result of worn sealant.

Jack

This is a device for raising the vehicle so that a wheel can be changed.

Kerb Weight

This is the empty weight of a motor vehicle as defined by the manufacturer.

Layout

This is the Interior design and details where furniture units are placed in relation to each other.

Leisure Battery

This supplies the power for the motorhome electrical systems and is sometimes called an auxiliary battery.

Levelling

The process of ensuring that a motorhome is level when sited on a pitch. It is important for comfort and also to ensure the correct functioning of the fridge and water systems.

LPG

Liquid Petroleum Gas, i.e. butane or propane.

L-Shaped

This is a term where the seating area of a motorhome is indeed L shaped.

Mains Hook-Up

This is a site facility where you can plug into a mains electricity supply.

Maximum User Payload

This is the maximum payload available for the user.

MIRO - Mass In Running Order

Weight of the motorhome equipped to the manufacturer's standard specification including essential habitational equipment

MTPLM - Maximum Technically Permissible Laden Mass

The technical maximum permissible laden weight of the motorhome, this must not be exceeded.

NCC

The only trade association representing manufacturers, retailers and suppliers within the motorhome industry.

Optional Equipment Payload

The payload provided by the Elddis for any factory fitted options that may be available.

Owners' Club

This is a group of people who usually own the same brand of motorhomes and enjoy meeting up for rallies.

Payload

The amount you can put into a motorhome. Specifically the difference between the Maximum Technical Permissible Laden Mass (MTPLM) and the Mass In Running Order (MIRO).

PDI

This is an inspection undertaken by the Retailer prior to handover to the customer.

**Pitch**

A designated area of a motorhome site allocated for the use of one outfit. Most sites will be arranged with defined pitches.

Propane

Gas used in colder conditions and is usually supplied in red cylinders.

RCD

This is a residual current device and is part of the electrical system that will 'trip' if there is an electrical fault.

Gas Regulator

Safety device fitted between the gas cylinder and the gas system of a motorhome, which controls the pressure of gas being released from the cylinder.

Road Lights

The external lights used while the vehicle is traveling.

Roof Lights - See Roof Vent.

Roof Vent

Is an opening unit in the ceiling that lets in ventilation and light, these vary in size, but the best ones will have integral blinds and flyscreens and are also called rooflights.

Semi-Rigid Pipe work

Is water pipes made of a semi rigid plastic and are infinitely preferable to cheaper convoluted piping which can act as a trap for germs and smells.

Slats

Sometimes used for beds and can improve ventilation to mattress cushions.

Space Heater

This is a type of heating equipment for the living quarters. Modern units fitted offer gas and mains-operation.

Speed Rating

This is the maximum speed at which a tyre may be used, as marked on its sidewall.

SMMT

Society of Motor Manufacturers and Traders.

Torque Wrench

A form of spanner used to set nuts and bolts to a specified degree of tightness. It is recommended for adjustment of wheel fixings on motorhomes.

User Payload

The weight of all items carried in the motorhome.

U-Shaped Settee

Usually a reference to seating that literally is 'U' shaped.

Vehicle Kerb weight

The weight of the tow car often indicated in the manufacturers specifications.

VIN - Vehicle Identification Number

This is a unique serial identification number for a vehicle. All cars and motorhomes should carry a VIN. Motorhomes are not obliged to, but most of those sold in recent years in the UK do.

Warranty

Are the terms and conditions that spell out your rights with regard to servicing, repair or replacement of parts as provided by the manufacturer.

Wild Camping

Term used for staying overnight away from a site. Illegal in many countries, but permission may be granted by individual landowners.



MOTORHOME ANNUAL SERVICE RECORD

In order to ensure your warranty remains valid an annual service must be carried out in accordance with the requirements of this handbook. You are responsible for any charges incurred for the service of your vehicle. If the annual service is performed by an authorised Eddis Approved Retailer / Service Centre or NCC Approved Workshop then The Explorer Group Ltd deems that the service has been performed correctly.

You may choose to have your annual service performed by an unauthorised repairer / service centre and if you do it will be your responsibility to ensure that the service meets our requirements.

We will ask you to provide a copy of the following documentation:

- Damp report
- Annual Habitation Service check list (to the minimum standard set out in this handbook)
- Invoice / dated service stamp

If the Annual Service has not been performed in accordance with the requirements in this handbook your warranty will be invalidated, however this will not affect your legal or statutory rights as a customer.

Eddis will not pay any unapproved Service Centre for the undertaking of any warranty work.

Minimum service requirements

The service must be undertaken by suitably qualified personnel.

A full damp test check should be undertaken and damp readings recorded.

A service check must be performed to the minimum standards set out below.

Annual Habitation Service check list

UNDERBODY

Item	Condition
Corner steadies, folding step and spare wheel carrier where applicable - check operation and lubricate	
Under slung tanks and pipes - check condition and security	
Body Attachment - check security of body to the chassis	

ELECTRICAL SYSTEMS

Item	Condition
Check the leisure battery is being charged from both the engine when running, or with a multi-tester (caravans) and the mains charger	
Leisure Battery (if fitted) - check condition of the battery & its compartment	
Leisure Battery (if fitted) - check condition, top up fluid if required and check the charge condition	
Interior lighting & equipment - check operation and fuse rating	
Awning light - check operation	
Wiring earths - check for defects on all ELV circuits (Visual)	
LV inlet plug & extension lead – check condition & resistance across pins	
Earth Bonding - visual inspection	



ELECTRICAL SYSTEMS (continued)

Item	Condition
RCD unit - check operation of RCD test button and operations of MCBs	
230V appliances - check operation	
Air conditioning (if fitted) - check operation	
2 x 7pin plug / 13 pin plug - check condition	

GAS SYSTEMS

Item	Condition
Regulator and gas hose - check age performance and security	
Perform a gas pressure check	
LPG Tank (if fitted) - check security	
Flame failure devices - check operation	
Gas cylinder - check security	
Gas dispersal holes - check they are clear from obstructions.	

APPLIANCES (check gas and electric operation)

Item	Condition
Fridge - check operation from 12V, 230V & gas	
Hob - check operation	
Oven - check operation	
Grill and fan - check operation	
Fridge - check operation	
Water boiler – Check operation	
Heater - check operation and top up header tank with anti-freeze (where applicable), bleed as necessary	

WATER SYSTEM

Item	Condition
Water pump & pressure switch - check operation	
Taps, pipes and micro switches - check operation	
Water filter housing & inline filter - check for leaks & replace filter where necessary	
Water system - check for leaks	
Water Tanks (if fitted) - check security of all water tanks including underslung tanks.	
Toilet - check security, operation of flush pump and free from obstructions.	
Drain down the system when checks are complete.	



VENTILATION

Item	Condition
Rooflights - check all are free from obstructions, cracks and have a free air flow	
Floor vents - remove protective cover and check they are clear from obstruction then refit covers	

FIRE & SAFETY

Item	Condition
Smoke and carbon dioxide detectors - check for operation via the test buttons fitted, check battery condition.	
Fire Extinguisher (if fitted) - check it is still within date	
Fire Blanket (if fitted) - check it is still within date	
Habitation door operation	
Motormover - check 12v cables are sealed at entry to battery box (where fitted)	

BODYWORK

Item	Condition
Doors and windows - check all catches are present and operating correctly.	
Blinds and flyscreens - check condition and operation	
Roof - check condition of roof.	
Cab seats - check condition of the seats and seats belts	
Floor - check condition of floor	
Furniture - check condition of the furniture	
Damp Test - undertake a damp test and record all readings taken.	
Lubricate all locks	



ANNUAL HABITATION SERVICE RECORDS

ANNUAL SERVICE RECORD

MOTORHOME MODEL

VEHICLE IDENTIFICATION NUMBER YEAR

1st SERVICE

DATE:

RETAILERS STAMP:

I/We certify that an annual service has been carried out in accordance with the manufacturers' and NCC recommendations.

2nd SERVICE

DATE:

RETAILERS STAMP:

I/We certify that an annual service has been carried out in accordance with the manufacturers' and NCC recommendations.

3rd SERVICE

DATE:

RETAILERS STAMP:

I/We certify that an annual service has been carried out in accordance with the manufacturers' and NCC recommendations.

4th SERVICE

DATE:

RETAILERS STAMP:

I/We certify that an annual service has been carried out in accordance with the manufacturers' and NCC recommendations.

5th SERVICE

DATE:

RETAILERS STAMP:

I/We certify that an annual service has been carried out in accordance with the manufacturers' and NCC recommendations.

6th SERVICE

DATE:

RETAILERS STAMP:

I/We certify that an annual service has been carried out in accordance with the manufacturers' and NCC recommendations.



7th SERVICE

DATE:

RETAILERS STAMP:

I/We certify that an annual service has been carried out in accordance with the manufacturers' and NCC recommendations.

8th SERVICE

DATE:

RETAILERS STAMP:

I/We certify that an annual service has been carried out in accordance with the manufacturers' and NCC recommendations.

9th SERVICE

DATE:

RETAILERS STAMP:

I/We certify that an annual service has been carried out in accordance with the manufacturers' and NCC recommendations.

10th SERVICE

DATE:

RETAILERS STAMP:

I/We certify that an annual service has been carried out in accordance with the manufacturers' and NCC recommendations.

11th SERVICE

DATE:

RETAILERS STAMP:

I/We certify that an annual service has been carried out in accordance with the manufacturers' and NCC recommendations.

12th SERVICE

DATE:

RETAILERS STAMP:

I/We certify that an annual service has been carried out in accordance with the manufacturers' and NCC recommendations.

13th SERVICE

DATE:

RETAILERS STAMP:

I/We certify that an annual service has been carried out in accordance with the manufacturers' and NCC recommendations.

14th SERVICE

DATE:

RETAILERS STAMP:

I/We certify that an annual service has been carried out in accordance with the manufacturers' and NCC recommendations.



15th SERVICE

DATE:

RETAILERS STAMP:

I/We certify that an annual service has been carried out in accordance with the manufacturers' and NCC recommendations.

16th SERVICE

DATE:

RETAILERS STAMP:

I/We certify that an annual service has been carried out in accordance with the manufacturers' and NCC recommendations.

17th SERVICE

DATE:

RETAILERS STAMP:

I/We certify that an annual service has been carried out in accordance with the manufacturers' and NCC recommendations.

18th SERVICE

DATE:

RETAILERS STAMP:

I/We certify that an annual service has been carried out in accordance with the manufacturers' and NCC recommendations.

19th SERVICE

DATE:

RETAILERS STAMP:

I/We certify that an annual service has been carried out in accordance with the manufacturers' and NCC recommendations.

20th SERVICE

DATE:

RETAILERS STAMP:

I/We certify that an annual service has been carried out in accordance with the manufacturers' and NCC recommendations.

21th SERVICE

DATE:

RETAILERS STAMP:

I/We certify that an annual service has been carried out in accordance with the manufacturers' and NCC recommendations.

22th SERVICE

DATE:

RETAILERS STAMP:

I/We certify that an annual service has been carried out in accordance with the manufacturers' and NCC recommendations.



NOTIFICATION OF CHANGE OF OWNERSHIP

If you purchase this vehicle as a used vehicle it may be possible to transfer the unexpired term of the warranty cover (up to a maximum of six years commencing at the original date of purchase from new). Please refer to the warranty section of the handbook for terms and conditions.

Please complete the attached form and post it to us along with the following information:

- A copy of the V5 registration form
- A copy of the habitation service handbook displaying a complete and up to date service history*
- A cheque for £50 made payable to Elddis.

Transfer of ownership must be made within the first three months of any change of legal ownership in order for the warranty cover to remain valid.

Elddis Customer Care
Delves lane
Consett
County Durham
DH8 7PE
www.elddis.co.uk

This form is also available for you to print from our web site.

.....<

NOTIFICATION OF CHANGE OF OWNERSHIP

Previous owner details (if known):

Name:

Address:

.....

Post code:

Email:

New owner details:

Name:

Address:

.....

Post code:

Email:

Daytime telephone number: Date of purchase:

Details of Motorhome:

Range: Model:

Vehicle identification number (17 digits):

* In order for you warranty to remain valid, your motorhome must have been serviced annually by an Approved Retailer / Service Centre, NCC Approved Workshop or NCC equivalent standard as set out in this handbook.

If you do not want to receive information about products and services from Elddis, please tick.



NOTIFICATION OF CHANGE TO NAME AND ADDRESS

In order that we can provide you with the very best level of service we ask that you keep us informed of any changes to your contact details.

Should your details change please complete the online form on our website, in our 'Customers' section. Alternatively, please complete the attached form and post to us:

Elddis Customer Care
Delves Lane
Consett
County Durham
DH8 7PE
www.elddis.co.uk

.....✂.....

NOTIFICATION OF CHANGE TO NAME AND ADDRESS

Previous details:

Name:

Address:

.....

..... Post code:

Email:

New details:

Name:

Address:

.....

..... Post code:

Daytime telephone number: Date of purchase:

Email:

Details of your Motorhome:

Range: Model:

Vehicle identification number (17 digits):

If you do not want to receive information about products and services from Elddis, please tick.

**A**

- Alarm system 10-1
- Automatic Charging System 8-2

B

- Battery Installation 8-1
- Battery Maintenance 8-1
- Bed make up 9-35, 9-36
- Bicycle racks 3-2
- Bulb Ratings 8-2

C

- Care of your Motorhome 11-1
- Charging System 8-2

D

- Door flyscreen 9-24
- Doors 9-26

E

- Electrical System 8-1
- Electricity 6-1
 - 12v Systems 6-1
 - Connecting To Mains Supply .. 6-1
 - Disconnecting Mains Supply .. 6-2
 - Generator/Charger 6-1
 - Mains Supply 6-1
 - Overseas Electrical
 - Connection 6-2
 - Power Supply Charger 6-1
- Entertainment System 9-33
- Equipment list 15-1

G

- Gas 6-3
 - Connection 6-3
 - Hoses 6-4
 - Regulator 6-3
- Gas Regulator 6-4
- Gas Safety Advice 7-1
- Generators / Charger 8-1
- Glossary 18-1

I

- Insulation 14-1

L

- Levelling 5-1
- Loading 3-1

M

- Mains Unit 8-1
- Motorhome Construction
 - Main Components 14-1
- Motorhome Construction -
 - Main Components
 - Solid Construction
 - Body Shell 14-1
 - Windows 14-1

N

- Notification of Change of
 - Ownership 20-1
- Notification of Change to
 - name and address 21-1



R

RCD 8-2
Refrigerator 9-6

S

Safety, general 2-1
Security 10-1
Service records 19-4
Site Regulations 5-1
Storage
 Long Term & Winter 12-1

T

Taps 9-25
Toilet
 Thetford C260 9-27

V

Ventilation 2-2

W

Water System 6-4
Wheel changing 11-3
Windows 9-24
Wiring diagram 16-1



Elddis



The Explorer Group Limited Delves Lane, Consett, Co. Durham DH8 7PE

Telephone: 01207 699000 • Facsimile: 01207 699001 • www.explorer-group.co.uk

All the illustrations and descriptive matter in this guide are intended to give a general idea of the caravan. Changing market and supply situations may prevent the manufacturer from maintaining the exact specifications and details in this handbook and we therefore reserve the right to alter specifications and materials as conditions demand.

Retailers are independent of the manufacturer and have absolutely no authority to bind the manufacturer by any express or implied undertaking or representation.

ACCORDO - Model Year 2016