

WELCOME & INTRODUCTION	1-1	LPG Gas System.....	6-3
End Of Life Vehicle Directive	1-1	Gas Supply	6-4
Erwin Hymer Group UK Technical Approvals.....	1-2	Connection.....	6-4
GENERAL SAFETY	2-1	Changing a Gas Cylinder.....	6-4
Please read before using your new Motorhome.....	2-1	Gas Regulator (Whirlwind/Autoquest Apex)	6-4
Correct And Safe Use Of Storage Areas In Motorhomes	2-1	Gas Regulator (Avalon/Quantum).....	6-5
Ventilation	2-2	Road Safe Gas Regulator.....	6-5
High-Level Ventilation.....	2-2	High Pressure Gas Hoses.....	6-6
Low-Level Ventilation.....	2-2	Water System	6-7
Ventilation in Separate Bedrooms.....	2-2	Filling your fresh Water Tank.....	6-7
Gas Dispersal Holes	2-2	Waste Water Tank.....	6-7
Fire Safety	2-2	Draining Down Your Water System	6-7
Fire Extinguishers	2-2	ELECTRICAL SYSTEM	7-1
In Case Of Fire	2-2	230V System	7-1
Fire Retardant Foams.....	2-2	Electricity Mains Supply.....	7-1
Habitation Door.....	2-2	Power Distribution Unit (PDU).....	7-1
PREPARING FOR THE ROAD	3-1	12V System.....	7-2
Motorhome Weights Explained	3-1	Automatic Charging System	7-2
Mass in Running Order.....	3-1	DC to DC Battery Booster.....	7-2
Maximum Technically Permissible Laden Mass	3-1	Battery Installation	7-3
User Payload	3-1	Battery Volt and Charge	7-4
Loading.....	3-1	Maximum Power Ratings for Internal Lights (where fitted).....	7-5
Before Moving Off.....	3-1	Mains Unit Whirlwind/Autoquest Apex (Under counter fridge)	7-6
Pulling Off	3-2	Mains Unit Whirlwind/Autoquest Apex (Full Height Fridge).....	7-7
Bicycle Racks	3-2	Mains Unit Avalon/Quantum (Under Counter Fridge)	7-8
Tow Bars.....	3-2	Mains Unit Avalon/Quantum (Full Fridge Height)	7-9
MOTORWAY HANDLING	4-1	HOW TO USE YOUR MOTORHOMES EQUIPMENT	8-1
Best Practice	4-1	Main Entrance Door Handle Operation (Whirlwind/Autoquest Apex)	8-2
Speed Limits.....	4-1	How To Operate Your Motorhome Entrance Door (Avalon/Quantum)	8-3
Towing Your Motorhome.....	4-1	Control Panel (Whirlwind/Autoquest Apex)	8-4
ARRIVING ON SITE	5-1	Vegas Button Control Panel.....	8-4
Check Site Regulations.....	5-1	Control Panel (Avalon/Quantum).....	8-6
Selecting A Pitch.....	5-1	Whale Heat Control (Whirlwind/Autoquest Apex)	8-9
Lateral Levelling (Side To Side)	5-1	Maintenance / Repairs	8-14
Leveller Jack.....	5-1	Whale Heat Control Panel Operation	8-15
Ramp.....	5-1	Troubleshooting - Whale Heat Electric Power Management	8-17
GETTING STARTED	6-1	Control Panel	8-18
Electricity	6-1	Troubleshooting - Whale Heat Control	8-18
Electricity Mains Supply.....	6-1	Maintenance / Repairs	8-19
Connecting To Mains Supply On Arrival at Site	6-1	Operating Instructions - Drain Valve	8-20
Overseas Electrical Connection	6-2		
Gas Safety Advice	6-3		
Facts about LPG.....	6-3		
Awning Spaces. LPG and Appliance Exhaust.....	6-3		

CONTENTS

Winterising	8-20	Tank Stop Mode	8-44
Alde Heating (3030 Control Panel) (Avalon/Quantum	8-21	Setting the Cooling Capacity	8-44
Turning the Boiler On and Off	8-21	Troubleshooting	8-46
Status Screen	8-21	Microwave	8-50
Set the desired Temperature	8-22	Smoke Alarm	8-51
Hot Water	8-22	Carbon Monoxide Alarm	8-53
Energy Sources	8-23	Alarm Activation	8-55
Heating with Electricity	8-23	Alarm Silence	8-56
Heating with Gas	8-23	Alarm in Absence	8-56
High Altitude Mode	8-23	System Status Indicators	8-56
Settings Menu	8-24	Rooflights	8-57
Glycol fluid	8-25	The Heki 2 (where fitted)	8-57
Refill the heating system with Glycol Liquid	8-25	To Open To The Tilted Position:	8-57
Service Information & Reset	8-26	To Open In The Intermediate Position	8-57
Oven (All Ranges)	8-27	To Open In The Ventilation Position:	8-57
Safety	8-27	Closing The Blinds:	8-57
Before using the Appliance:	8-28	Opening The Blinds:	8-57
Dual Fuel only:	8-28	MPK Rooflight (where fitted)	8-58
Oven shelf: (Applies to K1520 only)	8-29	Midi Heki Rooflight (where fitted)	8-59
Cooling system: (Applies to K1520 only)	8-29	The Omnivert (12v) Rooflight (where fitted)	8-59
Maintenance and Cleaning	8-29	Door Flyscreen	8-59
Troubleshooting	8-30	Windows	8-60
K1520	8-31	Shower	8-60
Use of the Burners	8-31	Taps	8-60
Use of the Electric Hotplate (if applicable)	8-32	Kitchen Taps	8-60
Use of the Grill	8-32	Internal Doors	8-61
Use of the Oven	8-33	Toilet/Shower Room Doors	8-61
Safe Cooking	8-33	Other Internal Doors	8-61
Temperature Control	8-34	Paddle Latch	8-61
Refrigerator	8-35	Concealed Latch	8-61
Electrical Operation	8-36	Magnetic Catches (Where Fitted)	8-62
Gas Operation (Liquid gas)	8-36	Thetford C-260 Cassette Toilet Range ..	8-63
Setting of Cooling Compartment Temperature	8-36	Introduction	8-63
Mains Power (230V)	8-37	Preparing for Use (Standard)	8-63
Gas Operation (Liquid Gas)	8-37	Using the Toilet (Standard)	8-63
Door Locking	8-38	Emptying	8-64
Storing food in the cooling compartment ..	8-39	Emptying with Optional Features	8-65
Storing food in the freezer	8-39	Cleaning and Maintenance	8-66
Shutting off the freezer	8-39	Toilet Bowl	8-66
Winter operation	8-40	Waste Holding Tank	8-66
Failure display	8-40	Cleaning and Maintenance for Optional Features	8-67
Troubleshooting	8-41 – 8-42	Winter Operation	8-67
RML10.4S/RMD10.5X/RMS10.5XS (Where Fitted)	8-43	Storage	8-67
Safety when Operating	8-43	Toilet unit malfunctions	8-67
Operating and Display Elements	8-44	Teleco TV Aerial	8-69
Using the Refrigerator	8-44	How to use your TV Aerial	8-69
Tips for Optimal Refrigerator Operation	8-44	Digital TV set-up Guide	8-71
Operating the Refrigerator	8-44	Connect Aerial and Power	8-71
		Troubleshooting guide	8-72

CONTENTS

How To Make Up Your Beds (Whirlwind/Autoquest Apex).....	8-73
Lift Up Bed (196 only).....	8-74
How To Make Up Your Beds (Whirlwind/Autoquest Apex 105, 120) ...	8-76, 8-77
How To Make Up Your Beds (Avalon/Quantum).....	8-78
Whale Easi-Slide Socket	8-80
Safety Information.....	8-80
Safety	8-80
Mobile Internet (Option).....	8-82
Pop-up Wireless Charging and USB Device (Avalon/Quantum).....	8-85
ISOFIX Child Seat Restraint	8-86
Air Conditioning.....	8-87
Solar Panel Regulator	8-94
Bike Rack	8-99
Roll Out Awning	8-101
Rear View System (Avalon/Quantum) .	8-113
SECURITY	9-1
Tracker (Option).....	9-1
Motorhome Theft	9-1
VIN CHIP	9-1
CARE OF YOUR MOTORHOME	10-1
Exterior Cleaning	10-1
Glass Fibre Reinforced Plastic (GRP)	10-1
Acrylic Windows	10-1
Window Blinds & Flyscreens.....	10-1
ABS - Wheel Spats & Panels.....	10-1
Interior Walls	10-2
Furniture	10-2
Taking care of your Upholstery:	10-2
Washroom And Handbasin Fittings.....	10-2
Shower Trays	10-3
Water Systems	10-3
Water Containers	10-3
Internal Water Systems.....	10-3
Thetford Toilet.....	10-3
Changing a Wheel.....	10-4
Tyres & Tyre Pressures	10-4
Tyre Wear and Damage	10-4
Pre-season Water System Preparation (Whirlwind/Autoquest Apex)	10-5
Getting Ready for the Winter (Whirlwind/Autoquest Apex).....	10-6
Winterising the Alde Water System (Avalon/Quantum).....	10-7
LPG System – Post Delivery Inspection, Replacement and Maintenance.....	10-8
STORAGE.....	11-1
Long Term & Winter Storage	11-1
Motorhome Covers	11-1
Battery Maintenance.....	11-1
MOTORHOME HABITATION WARRANTY COVER.....	12-1
Non warranty repairs.....	12-4
Remedial Work.....	12-4
MOTORHOME CONSTRUCTION - MAIN COMPONENTS	13-1
Solid Construction Body Shell	13-1
Windows	13-1
Insulation.....	13-1
ELECTRICAL DRAWINGS	14-1
Whirlwind/Autoquest Apex.....	14-1
Avalon/Quantum	14-2
GENERAL QUESTIONS	15-1
GLOSSARY	16-1
ANNUAL HABITATION SERVICE RECORDS.....	17-1
NOTIFICATION OF CHANGE OF OWNERSHIP.....	18-1
NOTIFICATION OF CHANGE TO NAME AND ADDRESS	19-1
INDEX.....	20-1

WELCOME & INTRODUCTION

Thank you for selecting your new motorhome.

Before you drive off, please familiarise yourself with the motorhome and read this owners' handbook. This will help you to obtain the maximum pleasure from your vehicle and avoid endangering yourself and others, refer to the base vehicle user handbook supplied with your motorhome.

Additional information and detailed appliance instruction manuals are also contained in your Owner's Information Pack

Your new motorhome has been designed as a recreational vehicle and is intended for recreational use only. It is not intended for business use or for permanent habitation. Erwin Hymer Group UK accepts no liability if the motorhome is used for any purpose other than recreational/holiday use. Any use other than recreational/holiday use will invalidate your warranty.

Please note: All Erwin Hymer Group UK motorhomes are classified as Grade 3 and therefore meet with the thermal insulation and heat levels for specific climatic conditions as specified within the British and European Standard BS EN 1646 part 1.

By following the instructions provided in this handbook and maintaining your motorhome in a first class roadworthy condition, you are sure to have many years of carefree use. To ensure the very best quality and reliability all motorhome designs and new developments are rigorously tested. Therefore Erwin Hymer Group UK will accept no liability or uphold the warranty if the motorhome is altered or modified in any way.

IMPORTANT

The VIN number of your motorhome must be quoted in all correspondence, it can be found on a plate fixed next to the chassis plate within the engine compartment.

The vehicle VIN number should be quoted in any communications with the base vehicle manufacturer.

Changing market and supply situations may prevent us from maintaining the exact specification details in this guide and we therefore reserve the right to alter specifications as materials and conditions demand and if necessary supply an alternative.

Enjoy your new motorhome.

www.elddis.co.uk
www.buccaneer-rv.co.uk
www.xplore-rv.co.uk

Please note – telephone numbers quoted in the following sections may incur charges.

End Of Life Vehicle Directive

Your new motorhome fully complies with the European Directive on the End of Life Vehicles. In order to obtain information on how to dispose of your motorhome at the end of its life please visit the base vehicle manufacturer website. The base vehicle manufacturer website contains full details on all base vehicle manufacturer products together with details of their environmental and recycling policies.

Erwin Hymer Group UK Technical Approvals

All Erwin Hymer Group UK Motorhomes have been European Commission Whole Vehicle Type approved. In order to ensure your new motorhome is safe to use Erwin Hymer Group UK are members of and have been inspected by the following bodies.

NCC who operate a certification scheme to ensure compliance with the European safety standards for motorhomes.

Erwin Hymer Group UK has also obtained ISO 9001.2015 accreditation and this is periodically audited.

Please note: All motorhomes manufactured by Erwin Hymer Group UK are designated by their model year. For example, 2022 Model year runs from 1st September 2021 to 31st August 2022.

GENERAL SAFETY

Please read before using your new motorhome.

In order for you to get the most out of your new motorhome it is necessary for you to be aware of the following:

- (i) Do not obstruct ventilators (See Safety Section - Ventilation)
- (ii) Inspect the flexible gas hose regularly for deterioration and renew as necessary, with approved type, as and in any case no later than the expiry date stated on the hose.
- (iii) Never use portable cooking or heating equipment inside your motorhome. Do not use your fitted cooking equipment as heating at any time.
- (iv) Never allow modification to your gas or electrical system unless qualified persons carry them out. A Gas Safe Register™ approved gas fitter should carry out all modification to the gas system. Any modifications carried out on the electrical system should be carried out by a suitably qualified electrician.
- (v) Never exceed your motorhome's Maximum Technical Permissible Laden Mass.
- (vi) Never exceed the front or rear axle maximum load as specified by the weight plate under the bonnet.
- (vii) Pull out/lift up worktop extensions, where fitted, are only designed to take maximum weight of 6kgs.
- (viii) Please ensure extra care when young children use high level bunks and always use the safety nets and lift up flaps provided.
- (ix) Do not leave children under 14 years of age unattended in your motorhome.
- (x) With the exception of the Alde heating system (where fitted) ensure all gas appliances are turned off while you are travelling.
- (xi) If you suspect there is a gas leak please open all the windows then vacate the motorhome. Switch off the gas supply if it is safe to do so. Then contact your nearest Erwin Hymer Group UK Retailer to arrange for them to check the gas system.

Only those seats designated for travelling should be occupied when the motorhome is in motion.

- Please note that motorhomes are covered by the seat belt regulations. In the correct car seat for their height or weight until they reach 135 cm tall or their 12th birthday, whichever is first
- wearing a seat belt if they're 12 or 13 years old, or younger and over 135cm tall
- (xiii) Before travelling in your motorhome: Ensure all the tables have been stored in their designated table storage position.
- (xiv) Ensure you remove all items from the microwave before travelling.
- (xv) It is essential that you have securely closed and locked the habitation door before setting off on any journey.
- (xvi) Care is to be taken when mounting and dismounting the toilet due to its elevated height.
- (xvii) Where a dividing curtain is fitted or provided, please ensure when not in use it is stored in the position furthest away from any cooking equipment or in the storage housing if provided.

Correct And Safe Use Of Storage Areas In Motorhomes

The storage areas provided in your motorhome are designed solely for the purpose of carrying personal possessions; these areas must not be used:

- As a habitation area (e.g. living, sleeping or cooking).
- To carry passengers, animals or livestock.
- For the installation (or use) of any LPG gas operated appliances, (unless supplied fitted by the manufacturer).
- For carrying LPG gas bottle cylinders, (unless designated by the manufacturer).
- To carry any flammable liquids, (unless properly stored, sealed and secured).
- For the operation of an electrical generator.
- In such a way that the loading exceeds the payload limit, as defined by the manufacturer.
- Such that the weight distribution of the vehicle means non-compliance with the vehicle axle loads.

VENTILATION

All motorhomes manufactured by Erwin Hymer Group UK are ventilated at both high and low level in accordance with BS EN 721 Safety Ventilation. The fixed ventilation points fitted in your motorhome must not be blocked under any circumstances as your safety may depend upon them. It is advisable that the fixed ventilation points are checked and cleaned (where necessary) on a regular basis.

High-Level Ventilation

This is mainly provided by fixed ventilation within the fitted roof skylight. These roof skylights should be cleaned annually by use of a small brush to remove any dust that may have accumulated around the mesh fitted. On some roof skylights the mesh can be easily removed to aid cleaning. On fan-assisted roof skylights it is essential that the fan is switched off prior to cleaning.

High level ventilation may also be provided by additional fitted mushroom vents.

Low-Level Ventilation

All Erwin Hymer Group UK Motorhomes have fixed low level ventilation provided. These ventilators are covered with plastic covers designed to prevent them from being obstructed by items placed within the bed box. These covers can be removed by undoing the two screws in order to facilitate cleaning the ventilators, however these covers must be replaced once cleaning is completed.

It is essential for your safety that these ventilators are not blocked at any time.

Ventilation in Separate Bedrooms

In motorhomes with separated sleeping areas, separate ventilation is required and is provided via a roof skylight at high level and a ventilator at low level.

Gas Dispersal Holes

All appliances and gas unions have a gas dispersal hole within the same compartment. It is essential that these are not blocked or made ineffective.

FIRE SAFETY

Fire Extinguishers

It is recommended that one dry powder fire extinguisher complying with EN 3-7 of at least 1kg capacity or equivalent is provided by the main door, and a fire blanket next to the cooker. Familiarise yourself with the instruction on your fire extinguisher and the local fire precaution arrangements.

In Case Of Fire

- (i) Get everyone out of the motorhome as quickly as possible using whichever exit is quickest including windows. Do not stop to collect any personal items.
- (ii) Raise the alarm. Call the fire brigade.
- (iii) Turn off gas container valve if safe to do so.
- (iv) Retreat to a safe distance.

Fire Retardant Foams

All motorhomes are equipped with Polyurethane (PU) foam which are combustion modified foam cushions, foam mattresses. All furnishings and fabrics used by Erwin Hymer Group UK comply with the Furniture and Furnishings (Fire Safety) Regulations.

Habitation Door

Note: Please ensure you only remove the key from the door with the key in the vertical position (12 o'clock).

PREPARING FOR THE ROAD

Before venturing out on to the road with your motorhome, it is important that you prepare correctly.

MOTORHOME WEIGHTS EXPLAINED

Mass in Running Order

The weight of your motorhome as it leaves the factory, as new with standard fixtures and fittings, plus an allowance for the driver of 75kgs, the mass of the fuel when the tank is full and an allowance of 10kgs per gas bottle, the number of gas bottles equal to the number of connections provided at the regulator.

Maximum Technically Permissible Laden Mass

The maximum mass the vehicle can be when fully laden for use on the road.

User Payload

The load margin (payload), this represents the difference between the Mass in Running Order and the Maximum Technically Permissible Laden Mass. It shows the maximum weight that can be loaded into your motorhome, covering items such as food, crockery, cutlery, clothing, bedding, etc.

Loading

It should be noted that even weight distribution is a major factor in making your motorhome an easy and pleasant vehicle to drive. Care should therefore be taken in balancing the load, ensuring that heavy items are well spaced and are in as low a position as possible, for example, low cupboards and bed boxes.

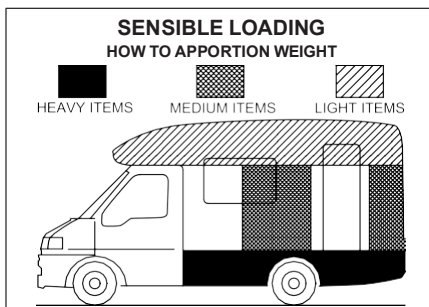

Note: Light items are considered as clothing and bedding. It is not recommended to travel with tinned items in overhead lockers.

IMPORTANT: Do not exceed maximum technical permissible laden mass for your motorhome.

BEFORE MOVING OFF

Whenever making a journey with your motorhome, either setting off on holiday or returning home, it is good practice to run through this simple checklist.

- (i) Close and secure all cupboards and drawers and secure any loose articles.
- (ii) Do not store tins, bottles, etc. in overhead lockers.
- (iii) **Close and secure all windows and roof lights.**
- (iv) Leave all curtains and blinds open to aid visibility.
- (v) Check that gas cylinders are securely fastened and that the valve on the gas cylinder is turned off. Also ensure that the gas locker door is securely locked.
- (vi) Turn off all gas appliances.
- (vii) Switch off 240volt supply at source; disconnect mains cable and store in an appropriate place.
- (viii) Check that the battery is secure and that the battery box door is locked.
- (ix) Ensure the fridge is on 12V operation and door lock is set. (Note: the electrical relays will allow the fridge to be run on the vehicle battery when the engine is running.)
- (x) Remove any external fresh water connections etc.
- (xi) Make sure any heavy articles are stored in accordance with the loading procedure.
- (xii) Lock habitation doors when travelling. We would recommend that all exterior doors, including the entrance door and access doors are firmly closed and locked prior to your departure.
- (xiii) Check your external rear view mirrors and adjust if necessary.

- (xiv) If a step is used, ensure it is put away before moving off.
- (xv) Your new Erwin Hymer Group UK motorhome has been designed to carry passengers in designated passenger seats only. The fitting of a 3-point seat belt can identify these seats. Any seat not fitted with a 3point seat belt is not designated as a passenger seat.
- (xvi) Ensure all tables have been stored in their designated table storage position.
- (xvii) Ensure you remove all items from the microwave (if fitted).
- (xviii) Check all the road lights are operational.
- (xix) Ensure the hob lid is in the closed position.

Pulling Off

- Pull away smoothly.
- Avoid wear and tear on clutch and transmission by taking extra care.
- Change gears smoothly.
- Try not to jerk the clutch.

Bicycle Racks

Your motorhome is fitted with bike rack rails. The rails are compatible with the Fiamma carry-bike pro M.

Fitting a bicycle rack to the rear panel of a motorhome will affect how weight is distributed. There are restraints to be aware of with such fitments.

The bike rack can carry a maximum of 60kgs.

The motorhome must also be balanced to take into account the new weight distribution. Weight must be distributed evenly.

Erwin Hymer Group UK cannot be held responsible for problems related to a bicycle rack fitted by a third party.

Tow Bars

Your new Erwin Hymer Group UK motorhome has been designed to accept a type approved tow bar. Full details on fitment are available upon request from Erwin Hymer Group UK.

MOTORWAY HANDLING

Best Practice

To gain the most enjoyment and ensure a long life for your motorhome, the following should be observed:

- Do not bump kerbs with wheels.
- When overtaking ensure sufficient clearance is given to other vehicles.
- Your Motorhome will not accelerate as quickly as a car, so take this into account when attempting to overtake other vehicles.
- Carry out all manoeuvres as smoothly as possible.
- Use the wing mirror to check your motorhome has cleared the other vehicle.
- Slow down and take care when driving over raised speed bumps, 'sleeping policemen' or when embarking/ disembarking ferries.
- In high or cross winds, travelling downhill or in conditions of poor visibility reduce your speed.
- High-sided vehicles can cause air buffeting so extra care must be taken when passing or being passed. Leave as much space as possible when overtaking these types of vehicles

Speed Limits

Be sure to observe all statutory speed limits and adapt your speed to take account of prevailing weather and road conditions.

Towing Your Motorhome

In the unlikely event that you have to tow your motorhome. Please refer to the base vehicle information for details on where to find the tow point and tow hook.

ARRIVING ON SITE

CHECK SITE REGULATIONS

On arrival at a campsite, you should always check the site regulations. This will help avoid any unnecessary conflict with site management and other site users.

SELECTING A PITCH

Carefully select where you wish to place your motorhome. The site should be as level as possible, preferably not under or near trees, well drained and away from possible boggy areas. Consider how you will move the motorhome when it is time to leave the site. On sloping ground it is better to pitch facing downhill, especially during wet weather.

LATERAL LEVELLING (SIDE TO SIDE)

A quick glance at your pitch should tell you if you are likely to need side to side levelling i.e. levelling across the axle. On uneven ground lateral levelling is accomplished by the use of a leveler jack or ramp and a spirit level placed 'across' the motorhome floor.

LEVELLER JACK

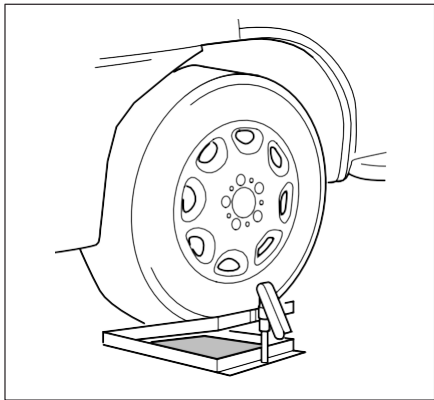

Place the leveller jack, folded flat, in front of the wheel that is to be raised to level the axle. Drive the motorhome onto the leveler jack and adjust the height until the spirit level shows that the motorhome is laterally level.

RAMP

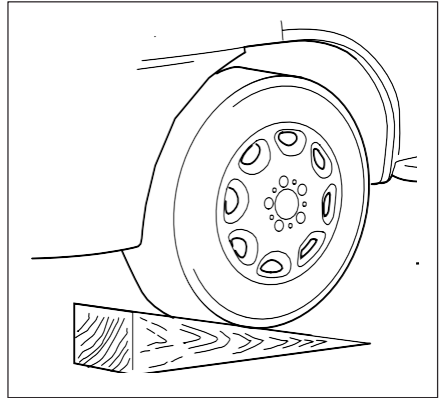

Reverse onto your pitch about a foot further back than you wish to end up. Then place the levelling ramp in front of the wheel that needs to be raised.

Place a spirit level parallel to the axle or just inside the motorhome door. It helps to have two people at this point. One should drive the motorhome very slowly forward moving the wheel up the ramp and the other should indicate when the spirit level bubble is in the middle.

Whichever method you use, once level, apply the motorhome handbrake and chock the motorhome wheel if necessary.

GETTING STARTED

You have arrived at your destination and now want to start to enjoy your new motorhome.

The following is a step by step guide to connecting your services and getting everything in your motorhome working.

ELECTRICITY

ELECTRICITY MAINS SUPPLY

Your motorhome's main electrical installation is designed to run on 230V at 50 hertz AC supply.

CONNECTING TO MAINS SUPPLY ON ARRIVAL AT SITE

Before connecting the motorhome installation to the mains supply, check that:

- (i) The mains supply is suitable for your installation and appliances, i.e. whether it is AC or DC and whether it is at the correct voltage and frequency.
- (ii) Your motorhome is properly earthed. Never accept a supply from a socket outlet or plug having only two pins, or from a lighting outlet.
- (iii) Any residual current device (earth leakage circuit breaker) in the mains supply to the motorhome has been tested within the last month. In case of doubt, consult the site owner or their agent.
- (iv) Make sure that the switch at the site supply point is off and that all electrical equipment in the motorhome is switched off by ensuring your motorhome mains isolating switch on the RCD is in the 'OFF' position.

Once the above checks have been made:

- (v) Remove any cover to the electricity inlet provided on the motorhome and insert the female connector of the flexible orange supply cable as shown.

Whirlwind/Autoquest Apex

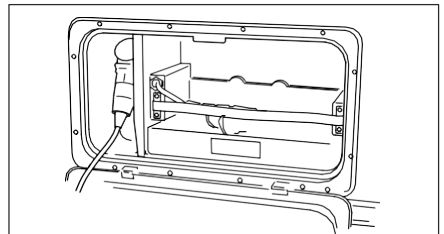

Avalon/Quantum

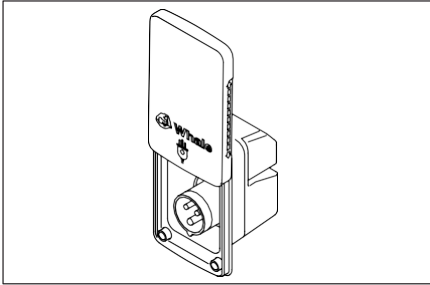

- (vi) Locate the site supply and remove any cover from the socket outlet provided at the supply point. Insert the male plug at the other end of the flexible orange

supply cable. Switch on the main switch at the site supply point (if appropriate).

- (vii) Place any surplus cable under the motorhome. Ensure that the surplus cable is not coiled up as it could overheat.
- (viii) The MCB main electricity supply switch should be put in the 'ON' position.
- (ix) Check the RCD is working by pressing the test button. Once pressed all electrical lights and appliances should cease to operate. Reset and then check the electrical system is operational.
- (x) Finally in order to get your 12V system operational, ensure the master 12V switch is in the 'ON' position.

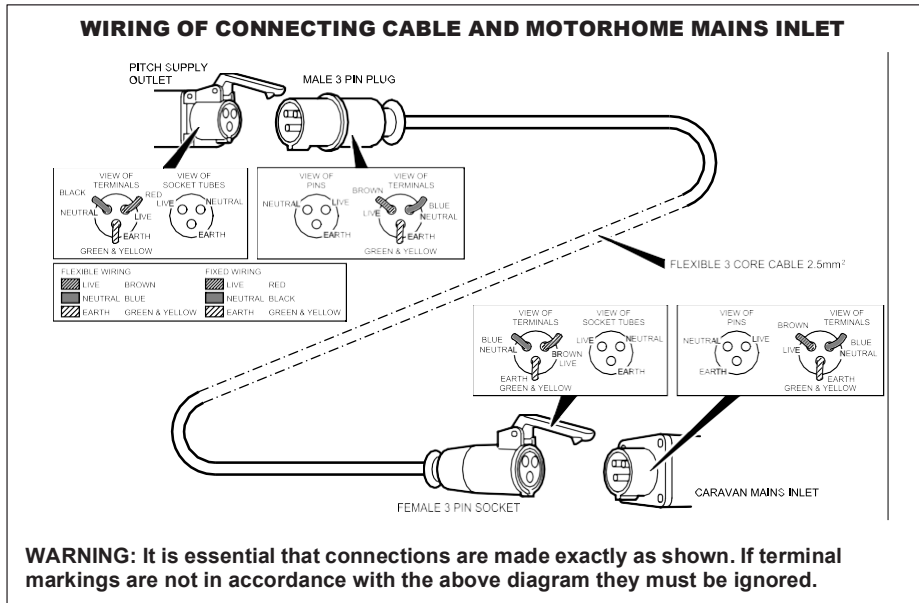

DISCONNECTING MAINS SUPPLY WHEN LEAVING SITE

- (i) Switch 'OFF' the RCD in the motorhomes distribution unit.
- (ii) Remove the male 3 pin plug from the site supply.
- (iii) Disconnect the female 3 pin plug from the motorhome and store the cable in an appropriate locker.

OVERSEAS ELECTRICAL CONNECTION

Please note: Connection to a mains voltage supply OVERSEAS requires particular attention.

Care must be taken when connecting supplies abroad since the supplies can be of REVERSE POLARITY.

The significance of REVERSE POLARITY is that when equipment is switched off, it may not be electrically isolated. The only certain way of making equipment safe is to unplug it.

A means of checking the polarity of the mains supply when overseas is recommended. There are several available proprietary makes of equipment for the purpose.

If it can be achieved, it is preferable to connect live to live and neutral to neutral to maintain full electrical protection.

CHECK all motorhome equipment is set-up to accept the site supply before actually switching on.

GAS SAFETY ADVICE

In the event of a suspected gas leak the gas must be turned off using the isolation valve on the gas bottle. A competent gas fitter should then check the system before it is used/reused.

Regularly check flexible gas hose, joints and connections for tightness. Finally, make sure that each gas appliance is working efficiently to the recommendations of the appliance manufacturers.

See Index - Ventilation

FACTS ABOUT LPG

- LPG is not poisonous.
- Bi-products of incomplete combustion are harmful to health.
- LPG is dangerous if all air and oxygen is excluded.
- LPG has been given a smell by the manufacturers in order to identify leaks.
- The gas is heavier than air and therefore sinks to the lowest point.

AWNING SPACES, LPG AND APPLIANCE EXHAUST

Using a refrigerator on gas which vents into an enclosed awning space must only be done if there is sufficient ventilation to prevent the build up of CO₂.

Space and Water heaters may produce sufficient amounts of CO₂ to pollute the awning space, if it is totally enclosed and therefore **MUST NOT BE** used on gas when an awning is attached.

Please note: Ventilation holes must be clear at all times.

LPG GAS SYSTEM

Erwin Hymer Group UK does not recommend the use of any external cylinders. All cylinders in use should be within the gas locker provided.

Please ensure that you have read the operating instructions for each gas appliance contained in your Owners Information Pack.

Please ensure that any gas hose left unconnected is protected from dirt or other foreign bodies entering the hose.

WARNINGS

- **Fresh air circulation should be allowed below the motorhome when appliances are in use and when flues terminate below the floor to allow free evacuation of the products of combustion. At least three sides of the underfloor space should always be kept open and unobstructed especially by snow. Do not make any additional openings in the floor.**
- **No appliance shall be used outside when connected to an internal outlet.**
- **Maintain adequate spacing of combustible materials from sources of heat or naked flame.**
- **Do not use additional independent gas appliances inside the motorhome.**

GAS SUPPLY

Your motorhome is designed to operate using either propane or butane liquefied petroleum gas at 30M/bar. Gas can be obtained from your motorhome dealer. Your motorhome is designed to accept a maximum 2 x 6-7kg gas bottles.





Connection

Make sure that heating and cooking appliances and gas cylinders are switched off.

Each gas appliance is connected to its own gas isolation valve. These are identified on the tap via a label. Below is a key to identify each label.

There will be a small label next to the bank of taps, which is also reproduced below.

To operate the tap the arrow on the tap shows the direction of flow for the gas.

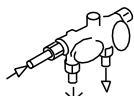
 Water Heater	 Cooking Appliance
 Space Heater	 Hob
 Refrigerator	 Gas On/Off

Changing a Gas Cylinder

Before commencing to change a gas cylinder ensure that the valve on the cylinder is turned fully off. Turn off all gas operated appliances.

Remove the gas hose from gas cylinder.

Before refitting a gas cylinder, ensure that all gas operated appliances are turned off - particularly after winterisation. Ensure all connections are secure.

When the cylinder is connected please ensure that the high pressure hose is not placed under any strain.

WARNING: If cylinders other than those recommended are used, ensure that the cylinders are adequately supported, do not block ventilation openings and care to be taken not to cause damage to fixtures and fittings located in the compartment.

Gas Regulator (Whirlwind/Autoquest Apex)

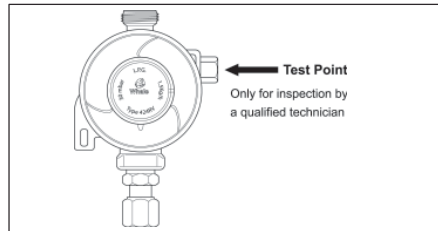

Your new motorhome has been fitted with a fully approved gas regulator designed to operate with both Butane and Propane gas at a gas pressure of 30mBar. Your regulator is fitted with a test point, which is accessed via the inlet at the side of the regulator. This access point is only for carrying out gas pressure tests and **must not** be used for any other purpose.

Please note: Only Gas Safe Register™ or STGW approved gas fitters can carry out any work on your motorhome gas installation.

This regulator is not designed for vehicle in motion.

Gas Regulator (Avalon/Quantum)

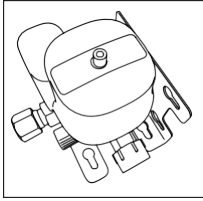

Your Motorhome is fitted with a Road safe gas regulator.

The operating instructions are given below.

Intended use

The Truma SecuMotion gas-pressure regulator is a device that ensures uniform gas pressure (30 mbar) with a permissible inlet pressure range of 0.3 - 16 bar.

SecuMotion regulates and monitors the consumption of liquid gas. If the specified consumption is exceeded or if the pressure at the regulator outlet falls below 27 mbar (due to gas pipe break, for example), the integrated gas flow monitor will shut off the flow of gas. A high pressure hose with a hose-break safety device is essential for connecting the SecuMotion gas pressure regulator to the gas cylinder.

Truma offers hoses with common connection fittings to enable use of gas cylinders with various valve connection sizes.

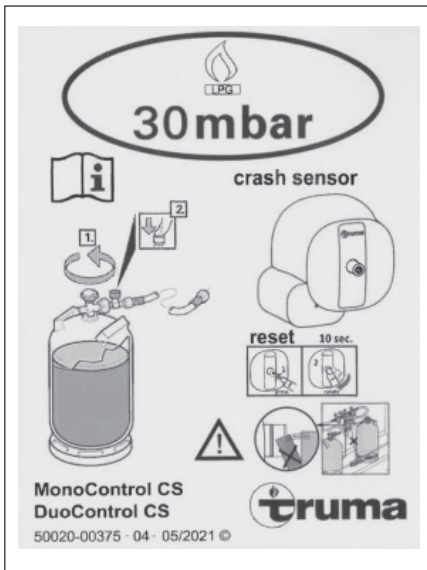

Your Motorhome has been supplied with a hose for connection to a propane gas bottle.

The integrated overpressure safety device complies with the requirements for a commercial safety device against impermissible pressure increases throughout Europe, a type tested liquefied-gas heating system **may be used** while driving (according to the EU directive 2001/56/EC) if the system includes a regulator with an appropriately configured gas installation.

Pressure regulating devices and hoses must be replaced with new ones no more than 10 years after their date of manufacture (every 8 years if used commercially). This is the responsibility of the operator.

ROAD SAFE GAS REGULATOR

Operating instructions

The use of upright gas cylinders from which gas is **taken in the gas phase** is mandatory for the operation of gas regulators, gas equipment and gas systems. Gas cylinders from which gas is taken in the liquid phase (e.g. for fork lifts) must not be used, since they would result in damage to the gas system.

Taking into operation

Open gas remote switch if present.

1. Open the cylinder's valve.
2. Firmly press the green reset button on the high pressure hose.
3. Press gas flow monitor reset button (green button) on gas pressure regulator **slowly**.
4. Release gas flow monitor reset button (green button) on gas pressure regulator **slowly** (3 seconds). If no pressure point is felt when the button is pressed again, the regulator is ready for operation (repeat procedure if necessary). Start the gas-burning devices if desired. If the gas cylinders are closed, SecuMotion may switch off after an extended period of no usage.

Changing a gas cylinder

Please use the included screwing tool to attach and remove the high pressure hoses. It will help you generate the necessary tightening torque and will prevent damage to the screw fittings, which may otherwise result from using an improper tool.

When the cylinder is connected please ensure that the high pressure hose is not placed under any strain.

Residual gas: No smoking! No open flames!

- Close the empty gas cylinder's valve.
- Remove the high pressure hose from the gas cylinder and remove the clip-on adapter, if present.
- Attach the high pressure hose to the full gas cylinder and apply the clip-on adapter, if present.
- Open the full cylinder's valve.
- Press the hose-break safety device and the gas-flow monitor (see "Taking into operation").

Anytime after making changes, check the hose connection to the cylinder valve for leaks (see "Checking for leaks in the high pressure area").

Exchanging hoses.

Please use the included screwing tool to attach and remove the high pressure hoses. It will help you generate the necessary tightening torque and will prevent damage to the screw fittings, which may otherwise result from using an improper tool.

Residual gas: No smoking! No open flames!

- Close the gas cylinder's valve.
- Remove the high pressure hose from the gas cylinder (or from the slip-on adapter) and from the regulator inlet.

When performing a hose change, please ensure that the white gasket provided with the hose (hose outlet - regulator inlet) is correctly installed and not damaged.

We recommend that the gasket (part no. 50020-76300) be replaced with every hose change.

- Screw country-specific high pressure hose to SecuMotion inlet and cylinder (or to adapter).

Open the gas cylinder's valve.

- Press the hose-break safety device and, if necessary, the gas-flow monitor (see "Taking into operation").

Anytime after making changes, check the hose connections to the cylinder valve and to the inlet of the SecuMotion gas-pressure regulator for leaks.

High Pressure Gas Hoses

You should only connect to this regulator using a length of approved high-pressure hose not exceeding 450mm from the gas cylinder to the regulator. These approved high-pressure hoses are available from your Erwin Hymer Group UK Retailer. These hoses are connected using screw thread fittings, which will make a seal if connected and tightened using a spanner. Once the hose is securely connected turn on the gas tap above the regulator, then turn on the gas bottle to allow gas to flow into the motorhome.

In order to make all your motorhome gas appliances operational it is necessary to open each appliance gas tap as detailed in previous column. All your gas appliances should now be operational. Instructions on how to use each appliance are detailed later in your handbook.

WARNING: Aerosols and highly flammable liquids must not be stored in the compartment behind, or adjacent to, any gas appliance. Some industrial LPG appliances operate at high pressure and require a 'high pressure' regulator. This often has an adjusting handle on it. NEVER use such a regulator on a motorhome.

Ventilation holes must be clear at all times.

WATER SYSTEM

Filling your fresh water tank

Your motorhome is fitted with a standard water inlet which can be filled using a hose pipe connected to a tap placed into the water filler point.

Please take care not to over fill your tank it is advised that someone monitors the water level in the tank while filling is in progress.

Waste Water Tank

Your new motorhome is also fitted with a waste water tank. All waste water excluding the toilet waste will run into the waste water tank. The level of water in the tank can be monitored using the control panel. Opening the grey waste outlet provided on the outside of the motorhome empties the tank. Open the tap when the outlet is over a drain and the water will run out of the tank.

Draining Down Your Water System

- (i) It is essential that you drain down your motorhome water system when it is not in use. This is most important during winter months to protect against frost damage
- (ii) Disconnect the water pump and switch off power supply.
- (iii) Open the safety drain valve on the water heater located next to the water heater.
- (iv) Open all taps and remove all plugs from sinks and showers. Lever operated taps should have the lever put into the up and central position.
- (v) Open both the blue and grey drain outlets on the outside of your motorhome.
- (vi) Adjust the level of the motorhome to ensure that the drain outlet is at the lowest point of the motorhome.

ELECTRICAL SYSTEM

Your motorhome's electrical system is comprised of both 230V circuits and 12V circuits. When connected to mains hook up your vehicle will take its power from this supply.

230V SYSTEM

ELECTRICITY MAINS SUPPLY

Your motorhome's main electrical installation is designed to run on 230V at 50 hertz AC supply.

WARNING: ALWAYS DISCONNECT THE MAINS SUPPLY BEFORE STARTING THE MOTORHOME ENGINE!

Power Distribution Unit (PDU)

Your motorhome is fitted with a power distribution unit (PDU) which is responsible for distributing power to the electrical outlets and appliances installed within the habitation area of the vehicle.

The individual 230V circuits are protected by means of Miniature Circuit Breakers (MCB) which provides overload protection to the relevant circuits. Additional protection for earth leakage is provided by the Residual Current Device (RCD), identified by the Main Isolation label.

For normal operation all switches on the unit need to be in the ON position.

In the event of an overload the MCB "trips" - automatically moves to the OFF position. After the overload has been removed the MCB can be re-set by switching to the ON position.

If an earth fault develops, or a person was to touch a live piece of equipment, the leakage of current to earth should immediately operate the RCD and "trip" the main switch, to the OFF position. This switch can only be re-set after elimination of the fault.

To reset, operate the switch as for MCBs. Whenever you connect to a site supply the RCD should be tested using the functional TEST button to ensure correct functionality.

NOTE: If a fault persists or in the event of difficulty consult an approved Electrical professional.

Simultaneous operation of all of the 230V mains electrical equipment may not be possible. A typical UK site mains hook-up point provides a maximum output of 16 amps and on some continental sites the available output may be as low as 5 amps. If your loading exceeds the site supply, it may trip the site circuit breaker. Please check the available mains output with your site operator. The following items need to be added together if used simultaneously.

230V mains equipment typical consumption figures:

- Refrigerator (Under counter) 0.50amps
- Refrigerator (Full height) 1.0amps
- Charger 0.50amps
- Water heater 3.9amps
- Blown air heaters 8.5amps
- Combi boiler (where fitted) 13amps
- Colour tv 3.33amps

12v System:

The 12V system is powered by means of an installed leisure battery or from the charger unit installed within the PDU.

The 12V circuits are provided with fault protection by means of the standard ATC/ATO automotive blade fuses.

When the ignition is switched on the 12V system in the motorhome is automatically switched off, and isolated. Meaning that the 12v system will not function.

NOTE: When the engine is running power is supplied to the refrigerator and the DC-DC booster.

AUTOMATIC CHARGING SYSTEM

The battery charger will operate automatically when the motorhome is connected to the mains outlet on a motorhome site. It is recommended that a leisure battery be always fitted to the motorhome when in use.

Note: (Avalon and Quantum models only): The charging unit charges the leisure battery and the vehicle battery.

(Autoquest/Whirlwind GT): The charging unit only charges the leisure battery and not the vehicle battery.

DC TO DC BATTERY BOOSTER (SCHAUDT WA 121525)

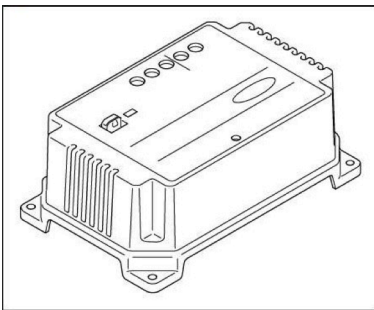

General

Your vehicle is fitted with a Schaudt DC booster unit which is fitted as the base vehicle has a 'smart alternator' installed.

The unit does not require any interaction from the end user or require any maintenance and will simply function as its intended, during the normal operation of the vehicle.

Function

The WA 121525 Booster is used for the optimum charging of leisure batteries such as lead-acid, led-gel, AGM.

The main purpose of the booster is to ensure the leisure battery remains charged whilst the vehicle is in motion. As the charge voltage for smart alternators varies greatly depending on the driving state. Without a booster fitted, the vehicle leisure batteries are at risk of discharge whilst the vehicle is in motion.

Location

The booster will be located within 1m of the vehicle's power distribution unit.

Please contact Erwin Hymer Group UK Ltd if any further information is required regarding this product.

Battery Installation

When installing the leisure battery please ensure that it is placed on the battery tray supplied with your motorhome. Then place the tray in the battery locker fitted to the side of your motorhome. Connect the battery to the clamp fittings connected to the connection leads within the battery box.

NOTE: The settings on battery related equipment such as the DC-DC booster are all pre-set to receive AGM type batteries.

We recommend that you refer to the NCC approved battery scheme, which can be found at www.thencc.org.uk.

Battery Maintenance

Storage

Ensure that the leisure battery is fully charged before placing the vehicle into storage.

Check the battery state every month, if the terminal voltage drops below 12.07V then recharging is necessary.

Charging should be carried out in a cool, dry well-ventilated area.

CAUTION: Do not place the battery onto cold surfaces such as concrete as this will affect the battery's ability to charge.

Points to remember

- Prolonged discharge causes harmful sulfation and may damage a battery.
- For peak performance never let a battery sit discharged for long periods of time.
- Over discharged batteries are permanently damaged and need to be replaced.

Note: Do not over discharge the battery. One of the most common causes of battery failure is when the battery is discharged below the recommended level of approximately 12.2v ref table. Discharging a battery below this figure will cause permanent damage. Overheating and gassing will occur when reconnected to the mains supply.

Whilst the charging voltage of the auxiliary battery is 13.8 volts, the units will not overcharge a battery in good condition. This, however, is not the case when a battery is faulty, as increased gassing and battery fluid loss can occur when attempting to recharge the battery.

	12 Volt Battery	State of Charge
Good	12.7V	100%
	12.5V	90%
OK	12.42V	80%
	12.32V	
	12.20V	60%
	12.06V	50%
Warning	11.9V	
	11.75V	30%
	11.58V	
Damaged	11.31V	10%
	10.5V	0%

Good: the battery is in good condition and not in need of charging

OK: nothing to worry about but put the battery on charge as soon as you can

Warning: get the battery on charge as soon as you can. Leave it and the battery will be damaged, possibly beyond repair.

Damaged: Replace battery

The battery charger that is fitted is designed to 'top up' the charge of your auxiliary (leisure) battery to an appropriate level it is not designed to charge a fully discharged (flat) battery.

Internal Lighting

Your new motorhome is fitted with all LED lighting.

MAXIMUM POWER RATINGS FOR INTERNAL LIGHTS (WHERE FITTED)

Type of Light	Maximum Rating (WATTS)
Downlights	1.2
Reading Lights	1.2
Small spotlights	0.36
Awning Light	5

LED tape is used as backlit mood lighting. The wattage varies from 4.8 to 9.6W depending on the location within the vehicle.

NOTE: All LED lights can only be replaced with a new complete unit and not a replacement bulb.

CAUTION: It is recommended to set the position of the reading light before switching on. Do not look directly at LED lights

GENERATOR/CHARGER

All electrical equipment fitted in your new motorhome can be run from either a controlled generator or charger whose output is maintained between 12volts and 14volts.

When connecting to a generator, always switch off the RCD, start the generator and allow running for a few minutes to stabilise. When this has happened, switch the RCD to the ON position.

PERIODIC INSPECTION

At least once every 3 years, the Motorhome electrical installation should be inspected and tested and a report on its condition obtained, as prescribed in British Standard BS7671.

**MAINS UNIT
WHIRLWIND/AUTOQUEST APEX
(UNDER COUNTER FRIDGE)**

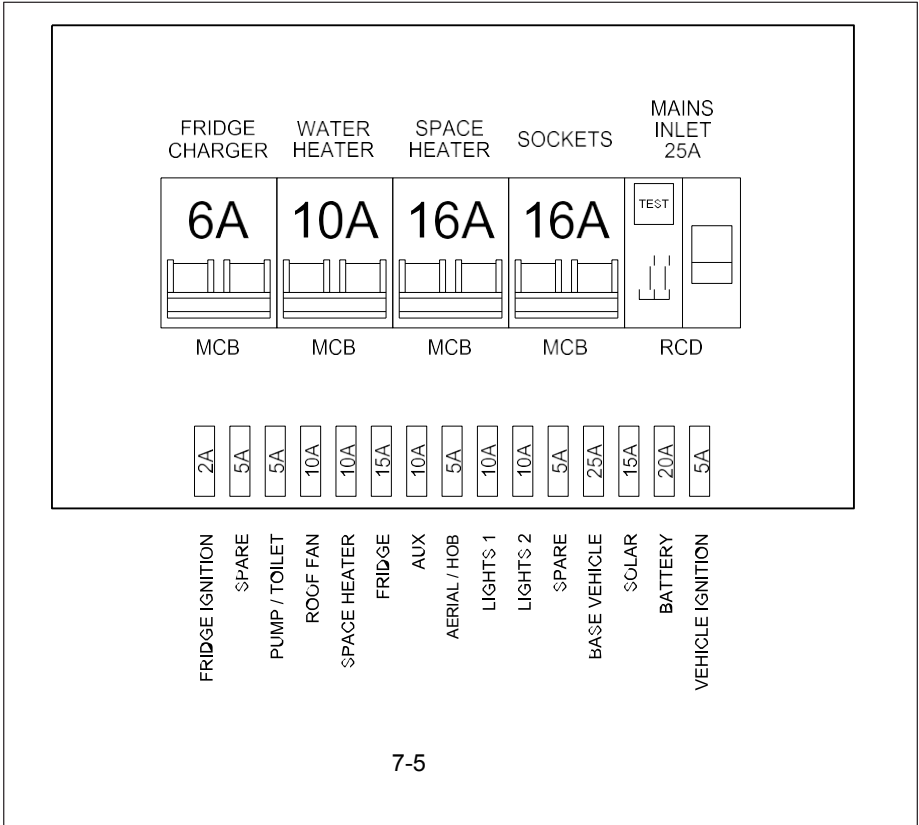

**MAINS UNIT
WHIRLWIND/AUTOQUEST APEX
(FULL HEIGHT FRIDGE)**

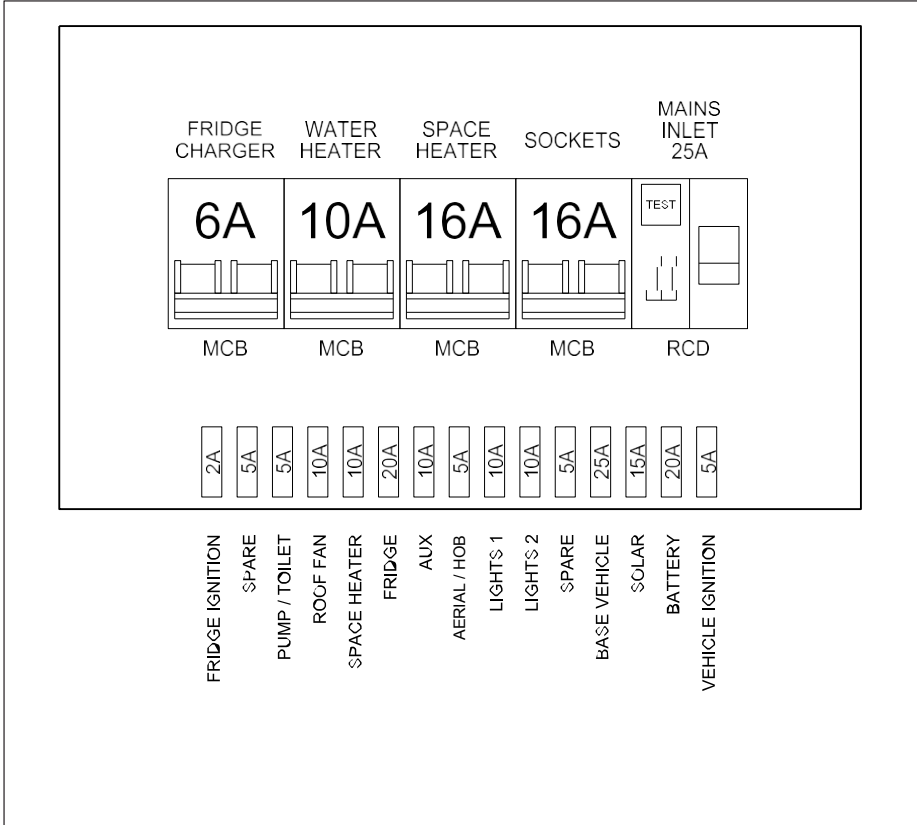

**MAINS UNIT
AVALON/QUANTUM (UNDER COUNTER FRIDGE)**

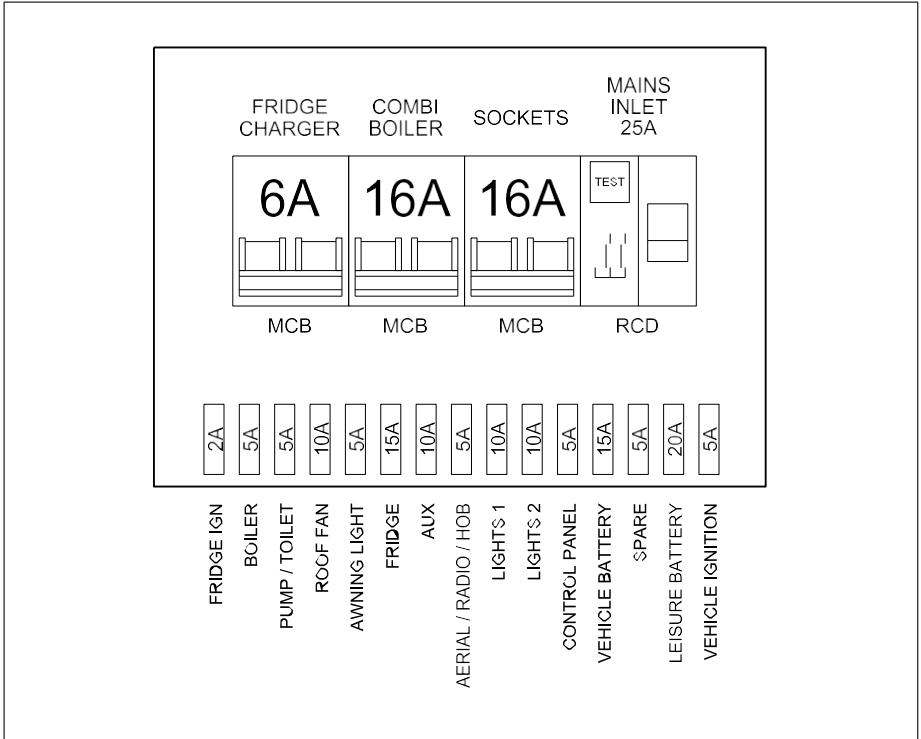

**MAINS UNIT
AVALON/QUANTUM (FULL HEIGHT FRIDGE)**

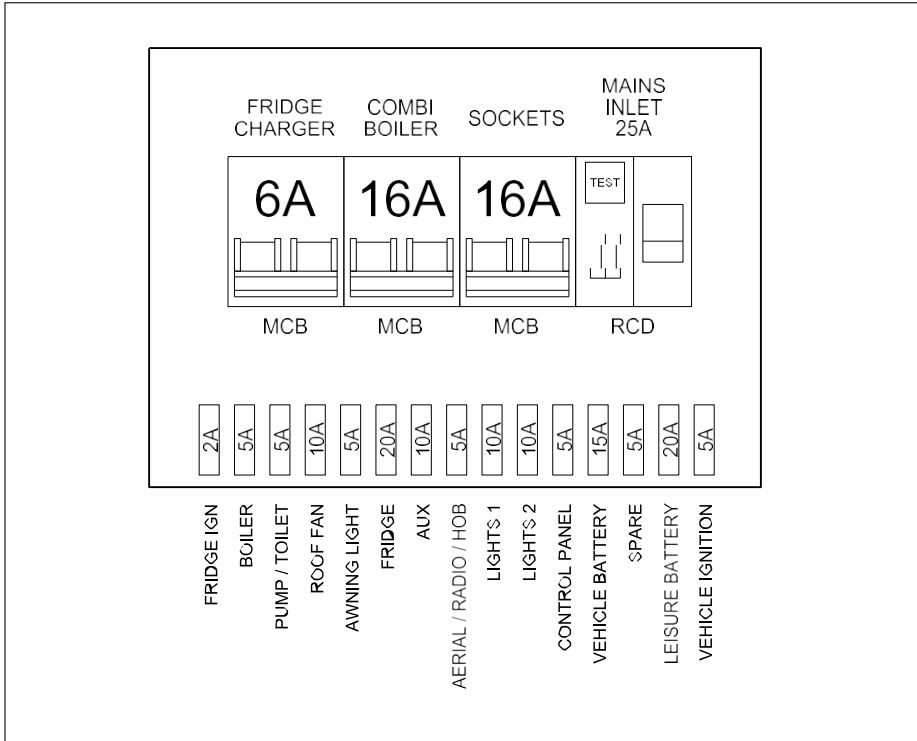

HOW TO USE YOUR MOTORHOME'S EQUIPMENT

Within this section of your motorhomes handbook we will give you brief details on how to operate all of the motorhomes equipment from the gas cooking equipment to the window blinds. For further details on the major equipment within your motorhome please read the individual appliance instructions contained with your user information pack.

Please note: Before attempting to use any gas equipment please ensure that the gas bottle is connected securely to the motorhomes regulator via a high pressure gas hose and the bottle valve is in the on position. Also ensure the appliance isolation valves are in the on position as shown in the gas system section.

Please note: Before attempting to use any electrical appliance please ensure that you have connected the mains connection cable to a mains hook up and that the mains isolation switch is in the on position. Ensure the 12V master switch is in the ON position. This is found in the side of the unit next to the entrance door.

MAIN ENTRANCE DOOR HANDLE OPERATION (WHIRLWIND AUTOQUEST APEX)

Your new Motorhome will be fitted with the following type of door handle and it is operated as described below.

Figure 1 shows the internal lever in the unlocked position. In order to open the door, press the lever down and the door will release open.

In order to close and lock the door, pull the door closed with moderate force, once the door has fixed in the closed position, push the lever up into the position shown in Figure

2. For the door to remain locked the lever must remain in the position shown.

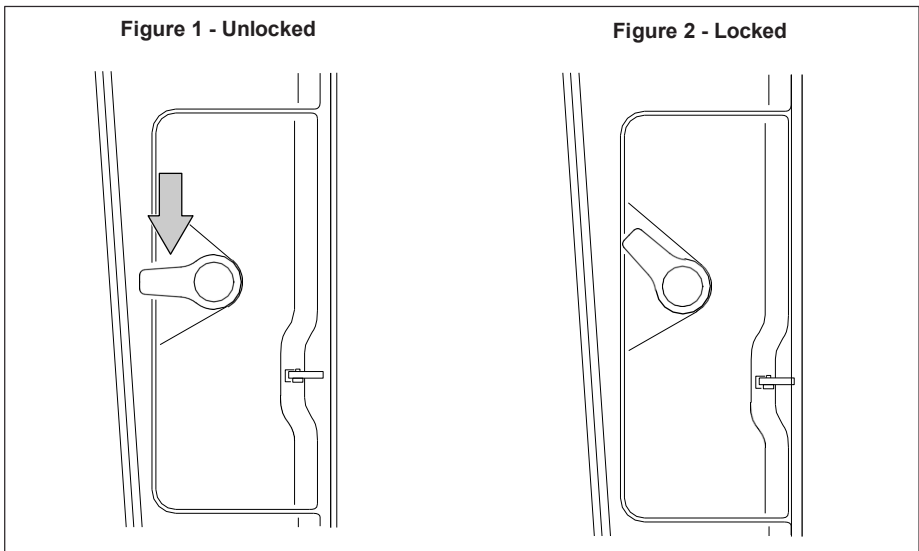

Please Note: Under no circumstance should the main door be operated when the vehicle is in motion. Should the door open during transit, please pull the motorhome over before operating the door.

HOW TO USE YOUR MOTORHOME'S EQUIPMENT

HOW TO OPERATE YOUR MOTORHOME ENTRANCE DOOR (AVALON/QUANTUM)

From the Outside

It is recommended that you always lock and unlock your Avalon/Quantum habitation door via the use of the key fob.

Once you have unlocked the entrance door, to open the door pull the lever shown opposite.

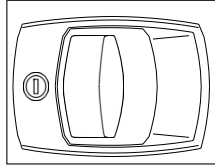

From the inside

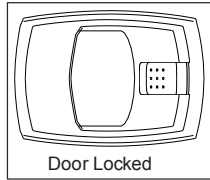
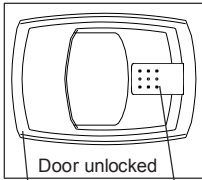

Large Lever

Locking Button

Opening the door

Pull the large lever towards you and if locked, the locking button will release. Pull the large lever towards you again and the door will open.

To close and lock your door

Pull the door closed to ensure it is fully latched so that no visible light can be seen past the door seal.

Now depress the locking button which can be found in the centre of the handle.

To check the door is locked, try pushing the door open without using the handle.

It is important that the locking button is in the locked position before you start your journey.

Do not attempt to open or close the door while the vehicle is in motion.

CONTROL PANEL (WHIRLWIND/AUTOQUEST APEX)

Vegas Button Control Panel

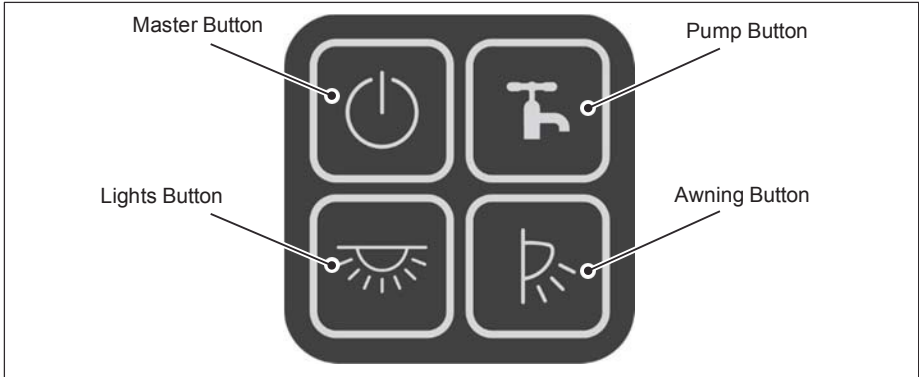

Master Button

When the Master Button is pressed, the control panel will switch power to all non-essential accessories.

- Some features, such as lights, will need the Master Button to be switched on to work.

Lights Button

When the Lights Button is pressed, the control panel will switch power to all the interior lights.

- The Master Button must be switched on for this button to affect the lights.

Pump Button

When the Pump Button is pressed, the control panel will switch power to the water pumps.

- Holding down the Pump Button forces the internal pump to run regardless of tank level. This is to purge the water system.

Awning Button

When the Awning Button is pressed the control panel will switch power to the exterior awning light.

- The Master Button must be enabled to control the awning light.

Vegas Voltmeter with Water Level Panel:

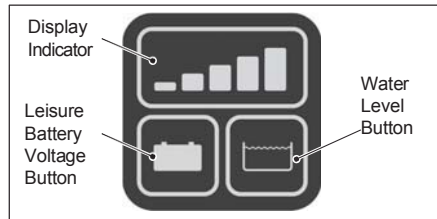

Display Indicator

The Display indicator on the Vegas Voltmeter Panel is used to display the Leisure Battery voltage and the Water level, depending on which button is pressed. Also depending on the model, it will display sensor alerts.

Display Alerts

- If a waste tank is fitted, the lowest indicator (Red) will illuminate when the waste tank is full.
- When the pump is running the 5th indicator (Green) will illuminate to indicate that the pump is currently running.

Note that when either the water level button or the battery voltage button is being held down, the Waste Full and Pump Running signals are not displayed on the panel.

HOW TO USE YOUR MOTORHOME'S EQUIPMENT

Leisure Battery Voltage Button

When the Leisure Battery Voltage Button is pressed, the Display Indicator will illuminate and display the voltage level of the Leisure Battery.

Voltmeter Voltage	Colour
12.20v	Red
12.32v	Amber
12.45v	Amber
12.57v	Green
12.70v	Green

Note: The voltage display should be used as a guide only and there is a degree of tolerance depending on the current load demand of the battery due to expected voltage drop between the voltmeter gauge and the battery itself.

Water Level Button

Your motorhome is fitted with a BCA 5Prong Probe System, which does not require calibration to work as intended.

When using the 5-Prong Probe System, pressing the Water Level Button will immediately take a reading and display the water level. Holding this button down takes a new reading every 5 seconds and will update the display accordingly. If the button is pressed and released within the 5 second timer, the panel will simply take and display a new water level measurement.

Water Level	Colour
20% or Lower	Red
21 %	Amber
41 - 60%	Amber
61 - 80%	Green
81 - 100%	Green

Note: The water level reading should be used as a guide only and there is a degree of tolerance depending on water type and temperature.

HOW TO USE YOUR MOTORHOME'S EQUIPMENT

CONTROL PANEL (AVALON/QUANTUM)

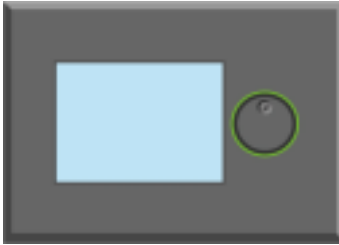

Overview

The control panel provides the user with a central point to check*:

- Leisure battery voltage
- Vehicle battery voltage
- Leisure battery current
- Vehicle battery current
- Load current
- Mains current
- Solar current
- Internal temperature
- External temperature
- Water level
- Waste level
- Pump source

The control panel also provides the user with the ability to*:

- Switch ON/OFF all non-essential electrical appliances/accessories
- Switch ON/OFF the lights
- Switch ON/OFF the pump
- Change the pump mode
- Switch off the awning light
- Switch over the battery supply from Leisure to Vehicle
- Charge the Vehicle battery when a mains 230V connection is present
- Calibrate the Water/Waste tanks
- Interface with ALDE heating (Compatible with ALDE 3020/3030 heater systems)
- Bluetooth connectivity (When the BCA Bluetooth Adapter is fitted)

The control panel also notifies the warnings depending on the status of the Leisure vehicle*:

- Battery over-voltage (Leisure & Vehicle)
- Battery under-voltage (Leisure & Vehicle)
- Low/empty water level
- Full waste tank
- Fuse blown
- Bluetooth LIN error
- ALDE LIN error
- Pump Running
- Thermistor faults (open & closed)
- Ignition signal present warning
- High Mains Current warning

*Depending on the specific configuration of the Leisure Vehicle, some of these functions will be disabled due to a lack of corresponding peripherals, for example, the Pump Select option will not be present in a vehicle with only a single pump.

Control Panel Interface

Each page can be controlled through the capacitive touch screen or via the rotary encoder.





A clock screen is the main screen on the Arizona control panel. It is the default screen which is seen after switching on the panel. The clock screen contains the following buttons:





Home button will take the user back to the home screen.

HOW TO USE YOUR MOTORHOME'S EQUIPMENT

 Master button will switch on the master. The Master needs to be on if the user wants to operate the pump, lights and other features in the vehicle.

 Light button will switch on the light circuits (Only if the Master is on).

 Awning light button will switch on the awning light (Independent of the Master).

 Pump button will enable/disable the pump (Only if the Master is on). When the pump is running this icon will display with a green box around it. When the pump stops running this green box will disappear.

Water Level

Pressing the  on the main menu screen will take you to the fresh-water screen which displays the current water level percentage (only when the master is on).

A low water level warning comes up on this screen and in the notification bar on the clock screen when the water level falls below a set value (default 10%) to indicate that the fresh-water tank is close to being empty.

Waste Water Level

Pressing the wastewater button , the screen will change to the wastewater screen. The wastewater screen displays the current waste level percentage (only when the master is on). The indicator level on the right goes up and down with the waste value

A high water level warning comes up on this screen and in the notification bar on the clock screen when the wastewater level rises above a set value (default is 90%) to indicate that the wastewater tank is close to being full.

Internal Temperature

Pressing the  button on the main home screen takes the user to the Internal Temperature Screen, on this screen the vehicle's internal temperature is displayed at the bottom, if there are any errors with the sensor then some red text will display to inform the user.

Battery Voltage Screen

Pressing the  button will take you to the leisure battery voltage screen which shows the current value of the voltage of the leisure battery.

When pressing the vehicle button , the screen will change to the vehicle battery voltage screen.





If battery select is enabled on this vehicle, there will be a small lightning bolt icon next to either this Leisure Battery icon or the Vehicle Battery icon, this indicates which is currently set as the power source.

If battery select is enabled, to switch the power source from the Leisure Battery to the Vehicle Battery first tap the vehicle icon to switch to the Vehicle Battery Voltage Screen, then tap the same button again and the lightning bolt should swap from the Leisure Battery to the Vehicle Battery, this swaps the power source. To change back to Leisure Battery press the Leisure Battery button to go back to the Leisure Battery Voltage screen, then press the button again to swap back to Leisure Battery.

Battery Current Screen

Pressing the  button on the main screen takes you to the Leisure Battery Current screen, this screen shows the amount of current being used or charging the Leisure Battery.



As the figure above shows if the current goes above a set value (default 18.0A) then a High Leisure Current warning will occur to indicate that a large amount of current is being drawn from the Leisure Battery. This will also display a warning icon on the notification bar on the clock screen.

Any of the , , , and  current screens can be accessed from each other with the 4 icons on the bottom of each of these screens.

Pressing the  button on any of the current screens takes you to the Load Current screen, this screen shows the amount of current being used or charging the Vehicle Battery. As the figure above shows if the current goes above a set value (default



20.0A) then a High Load Current warning will occur to indicate that a large amount of current is being drawn from the Vehicle Battery. This will also display a warning icon on the notification bar on the clock screen. Pressing the  button on any of the current screens takes you to the Mains Current screen, this screen shows the amount of current being used by the 230v system. As the figure above shows if the current goes above a set value (default 10.0A) then a High Mains Current warning will occur to indicate that a large amount of current is being drawn from the site mains supply. This will also display a warning icon on the notification bar on the clock screen. If too much power is drawn from the site mains supply it could trip the supply breakers and cause a power interruption.

Solar Panel

Pressing the  button will take you to the solar panel screen which displays the current value of the generating current from the solar panel connected to the rest of the vehicle's electrical system.  Home button will take the user back to the home screen (Figure 4.1.1: Home Screen).

If the solar panel is drawing over a set value (default 10.0A) then a high solar current warning will display on this page and on the notification bar to inform the user that their solar panel system is providing a very high current which may cause the solar fuse to blow.

Notification Screen

The notification button on the main has 3 different icons that may be displayed on the home screen, the  icon is for the notification screen when there are no warnings, notifications or errors to view, when the icon is  (Yellow Triangle) this image it means that there are notifications to check, this icon  (Red Triangle) means that there are warnings or errors that need checking.

If multiple notifications are displayed on this page, then using the touch screen the user can swipe up or down to view the additional notifications or warnings.



Pump Settings

Pressing the  button on the home screen will take the user to the Pump Settings Screen, on this screen if the vehicle has multiple pumps then the user can press the "I/E" button to switch between the internal pump and the external pump.

Setting Screens

Pressing the  button on the home screen will take the user to the Setting Screens

Setting the time:

The plus  and the minus  icons are used to increase or decrease the hours (left number) and the minutes (right number).

Warranty

If you believe there is a problem with your control panel, please contact your dealer who will be able to help.

HOW TO USE YOUR MOTORHOME'S EQUIPMENT

WHALE HEAT CONTROL (WHIRLWIND/AUTOQUEST APEX)

Instructions for Use



Icon	Description
	Gas heating button
	Gas heating standby indicator
	Gas heating on
	Frost protection mode (approx 5°C)
	Night time mode (approx 16°C)
	Increase temperature button
	Decrease temperature button
	Lockout indicator
	Electric heating button
	Electric heating standby indicator
	0.75kW electric
	1.50kW electric
	3.00kW electric
	External control from alternative source available*
	External control from alternative source active*
	Reset button

*Not available on all models. External control will allow control of the heater via an alternative source. Please refer to your vehicle handbook for more information.

HOW TO USE YOUR MOTORHOME'S EQUIPMENT

1. Select Temperature

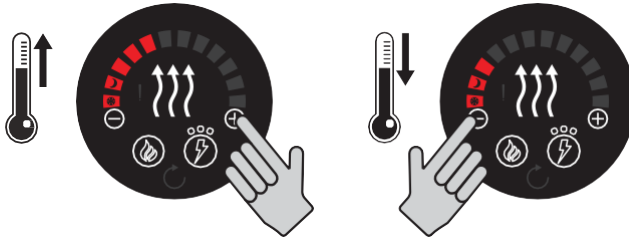

2. Activate Gas Power

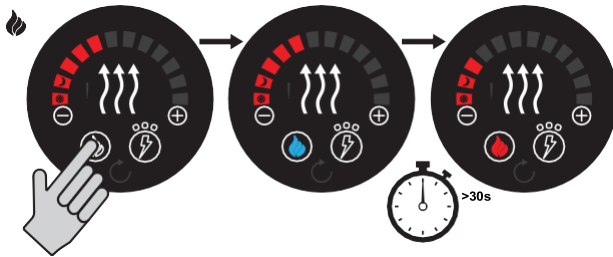

And/Or



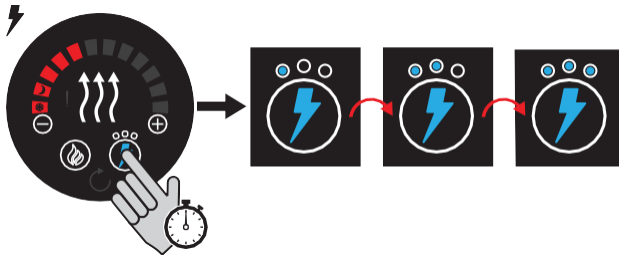

3a. Select Electric Setting

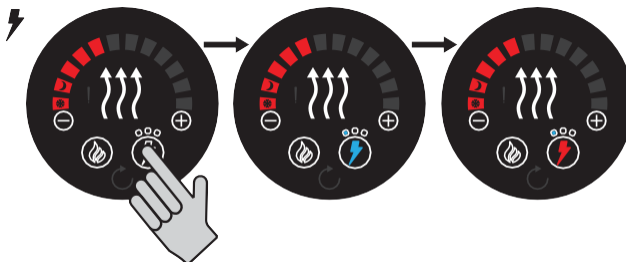



3b. Activate Electric Power

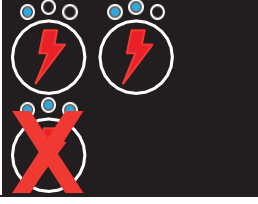

HOW TO USE YOUR MOTORHOME'S EQUIPMENT

Usable Electric Settings		
6A 0.75kW 230V a.c.		
10A 1.50kW 230V a.c.		
16A 3.00kW 230V a.c.		

Troubleshooting - Whale Heat Control

Step 1 - Show Lockout	
	
Step 2 - Identify Lockout	Step 3 - Recommended Action
1 	Inadequate gas supply 1. Check gas 2. 30mbar LPG 3. Go to step 4
2 	Overheat 1. Check air vents and ducts are not restricted 2. Wait 10 mins for heater to cool down 3. Go to step 4

HOW TO USE YOUR MOTORHOME'S EQUIPMENT

3



Inadequate supply voltage

10.5 - 15.9V d.c. Heater inoperable under 10.1V





$\geq 10.5 / \leq 15.9V$ d.c. ✓

$< 10.5 / > 15.9V$ d.c. ✗

Go to step 4

HOW TO USE YOUR MOTORHOME'S EQUIPMENT

Troubleshooting - Whale Heat Control (continued)

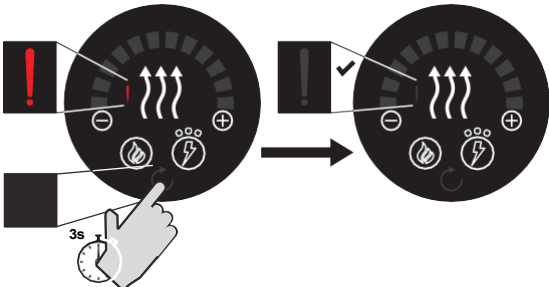
Step 2 - Identify Lockout	Step 3 - Recommended Action
<p>4</p> 	<p>Flue blockage</p> <ol style="list-style-type: none"> 1. Check flues for blockages 2. Go to step 4
<p>5</p> 	<p>Internal fault</p> <ol style="list-style-type: none"> 1. Call Whale support +44 (0)345 9090 911 For Europe, please see enclosed Webasto- Service information. 2. Go to step 4.
<p>6</p> 	<p>Control panel fault</p> <ol style="list-style-type: none"> 1. Power off 2. Power on
<p>7</p> 	<p>Multiple faults</p> <ol style="list-style-type: none"> 1. Power off 2. Check heater for recurring faults 3. Power on 4. Go to step 4.
<p>Step 4 - Clear Lockout</p>	
	

If problems persist, please contact Whale Support on +44 (0)345 9090 911. For Europe, please see enclosed Webasto-Service Information.

Maintenance / Repairs

The vehicle owner must arrange for the appliance to be serviced at least every 2 years from date of purchase, including its gas supply and ducting for the products of combustion (BS EN 624).

All maintenance and repairs must be carried out by a registered gas engineer at a Whale Approved Service Centre or by a member of the Whale Service Engineer Network.

For installation or service information, contact Whale Support.

Tel: +44 (0)345 9090 911

Email: Info@whalepumps.com

For Europe, please see enclosed Webasto-Service information.

Guarantee claims, warranty claims and acceptance of liability will be ruled out in the event of the following:

- Modifications to the appliance (including accessories)
- Modifications to the exhaust duct or combustion intake
- Use of replacement and accessory parts other than original Whale parts
- Failure to follow the installation and operating instructions
- Use of the appliance for non-leisure purposes

The heat exchanger **must be** replaced with a Whale original spare part every 10 years from date of registration. See the data label on the heater for the first time it was put into service.

Disposal

This product must be disposed of in accordance with the regulations of the respective country in which it is used. National regulations and laws must be observed.

Please note: The appliance **must be** installed and serviced in accordance with any relevant regulations in the country where the appliance is installed.

If the electrical supply cord is damaged, it must be replaced by the manufacturer, its service agents or similarly qualified persons in order to avoid a hazard (BS EN 60335-1).

HOW TO USE YOUR MOTORHOME'S EQUIPMENT

Whale Heat Control Panel Operation



Icon	Description
	Gas heating button
	Gas heating standby indicator
	Gas heating on
	Frost protection mode
	Eco mode
	Increase temperature button
	Decrease temperature button
	Lockout indicator
	Electric heating button
	Electric heating standby indicator
	0.38kW electric
	0.75kW electric
	1.50kW electric
	External control from alternative source available*
	External control from alternative source active*
	Reset button

*Not available on all models. External control will allow control of the heater via an alternative source.

Please refer to your vehicle handbook for more information.

HOW TO USE YOUR MOTORHOME'S EQUIPMENT

Select Temperature



Activate Gas Power

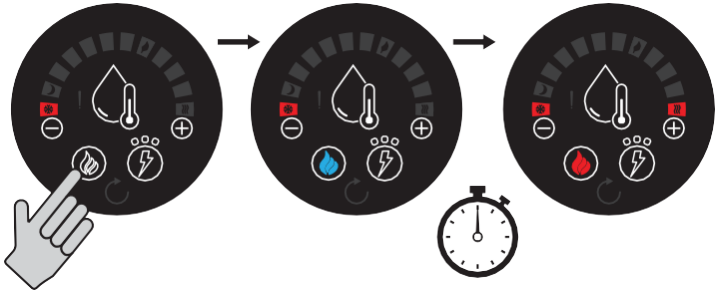

Activate Electric Power

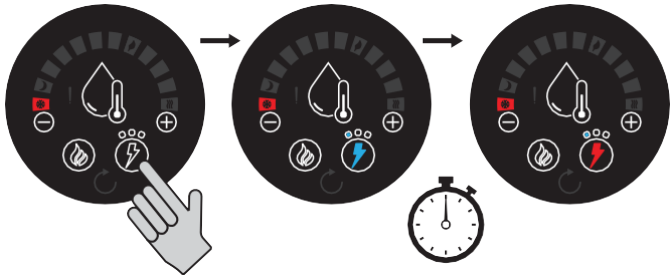

Select Electric Setting

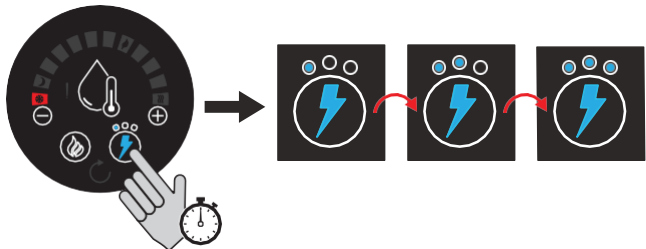

HOW TO USE YOUR MOTORHOME'S EQUIPMENT

Water Temperature Display

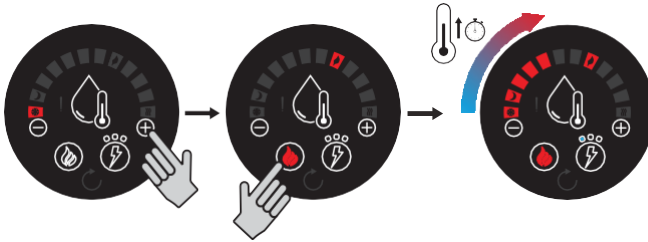

*Not available on all models. Electric settings only available on Gas & Electric Heat Control Panel models.







Usable Electric Settings		
1.6A 0.4kW 230V a.c.		
3.3A 0.75kW 230V a.c.		
6.5A 1.50kW 230V a.c.		

Electric Power Management

For dual Heat Control Panel variants, when selecting a high electric setting on the space or water heater, the control panel may automatically step down the other Heat Control Panel to a lower electric setting or turn off if at risk of exceeding 16A. The last heater selected has AC mains priority.

HOW TO USE YOUR MOTORHOME'S EQUIPMENT

Troubleshooting - Whale Heat Control Panel

Step 1 - Show Lockout	
	
Step 2 - Identify Lockout	Step 3 - Recommended Action
1	 <p>Fault type #1 - Inadequate gas supply</p> <ol style="list-style-type: none"> 1. Check gas 2. Temp <5°C, use Propane rather than Butane 3. Check flue for blockages 4. Go to step 4
2-3	 <p>Fault type #2-3 - Overheat Fault</p> <ol style="list-style-type: none"> 1. Check heater is completely full of water 2. Run pump with one hot tap open until water flows smoothly 3. Go to step 4
4	 <p>Fault type #4 - Low Voltage Fault</p> <p>10.5 - 15.9V d.c. Heater inoperable under 10.1V $\geq 10.5 / \leq 15.9V$ d.c. ✓ $< 10.5 / > 15.9V$ d.c. ✗</p> <p>Go to step 4</p>
5	 <p>Fault type #5 - Air Pressure Fault</p> <ol style="list-style-type: none"> 1. Check flues for blockages 2. Go to step 4
6-11	 <p>Fault type #6-11 - Internal Fault</p> <ol style="list-style-type: none"> 3. Go to step 4 4. Call Whale Support +44 (0)345 9090 911
12	 <p>Fault type #12</p> <ol style="list-style-type: none"> 1. Power off 2. Check Heater for recurring faults 3. Power On 4. Go to step 4

HOW TO USE YOUR MOTORHOME'S EQUIPMENT

Step 4 - Clear Lockout

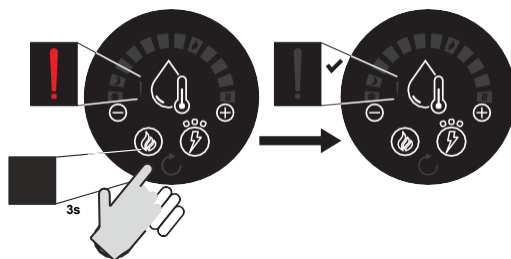

If problems persist, please contact Whale Support on +44 (0)345 9090 911. For Europe, please see enclosed Webasto-Service Information.

Maintenance / Repairs

To clean and sterilise inside the Water Heater use diluted sterilising fluid and fully rinse through with clean water afterwards. The outside of the appliance should not normally require cleaning. If it does, isolate the electrical supplies and wipe down with a soft, damp cloth only. Do not use abrasive cleaners. Allow to fully dry before reconnecting the electrical supplies. If de-scaling of this appliance is required, this can be done using a domestic liquid de-scaling product and fully rinse through with clean water afterwards. Cleaning and user maintenance must not be carried out by children without supervision.

The Whale Water Heater **must be** checked periodically by a Whale Approved Service Centre/ Technician, or competent person, at least annually. This **must be** completed according to the practice in the country where it is used and according to the Whale instructions. Whale recommends annual testing of gas soundness and combustion by an accredited LPG engineer. The appliance contains ESD sensitive components and therefore **must only** be opened by a Whale Approved Service Centre/Technician. To contact Whale support telephone: +44 (0)345 9090 911.

HOW TO USE YOUR MOTORHOME'S EQUIPMENT

Operating Instructions - Drain Valve

The Water Heater must be drained before travelling or if it is not being used for a period of more than 3 days, or if there is a danger of freezing (unless Frost Protection setting is active). Check the heater has fully drained if there is a risk of freezing. The drain valve is located at the top of the water heater, beside the cold and hot water inlet. To operate the drain valve, turn the yellow lever clockwise 90 degrees.

If the plumbing system in the vehicle causes air locking preventing the water heater from draining, consideration should be given to fitting a vacuum relief valve, Whale Part # AK1228.

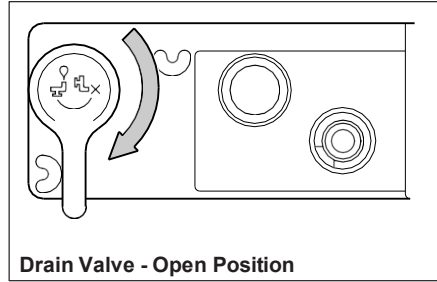
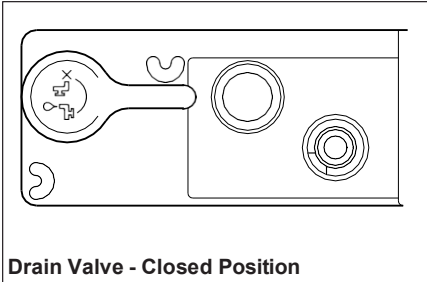

Winterising

If the Water Heater is not going to be used for more than 3 days, disable the Water Heater on the control panel, isolate the gas supply by ensuring the gas shut off valve to the Water Heater is closed and that the gas supply is turned off (if no other gas appliances require a continued supply). The Water Heater must be fully drained to avoid risk of freezing.

General Safety Note: The operating pressure of the gas supply to the Water Heater must be either 28-30mBar Butane or Propane.

Maintenance

To clean and sterilise inside the Water Heater use diluted sterilising fluid and fully rinse through with clean water afterwards. The outside of the appliance should not normally require cleaning. If it does, isolate the electrical supplies and wipe down with a soft, damp cloth only. Do not use abrasive cleaners. Allow to fully dry before reconnecting the electrical supplies. If descaling of this appliance is required, this can be done using a domestic liquid descaling product and fully rinse through with clean water afterwards. Cleaning and user maintenance must not be carried out by children without supervision.

Please Note: Water will drip from the discharge pipe of the pressure-relief valve during heating up. The pressure relief valve must be operated regularly (at least twice a year) by turning the yellow lever in the anti-clockwise direction, to remove lime deposits and to ensure that it is not blocked.

The Whale Heater must be checked periodically by a Whale Approved Service Centre/Technician, or a competent person, at least annually. This must be completed according to the practice in the country where it is used and according to the Whale instructions. Whale recommends annual testing of gas soundness and combustion by an accredited LPG engineer. The appliance contains ESD sensitive components and therefore must only be opened by a Whale Approved Service Centre/Technician.

ALDE HEATING (3030 CONTROL PANEL) (AVALON/QUANTUM)

Turning the boiler on and off

Start the system by pressing the On/Off button on the control panel (Fig. 1). The start image is displayed (Fig. 2) and the system starts with the last selected settings. When the heating system and control panel are on, a green diode lights up on the On/Off button.

To turn off the heating system, press the on/off button. The control panel and LED switch off.



Fig 1. System switched off, LED off



Fig 2. System starts, LED lights up

Note: If the “Status page” is set to “Dark”, the Control Panel goes dark when it enters sleep mode, but lights up when you touch the screen.

Status Screen

When the control panel enters sleep mode, the status screen appears. Tap the respective symbol on the status screen to reach its submenu. Press the “MENU” button to reach the Settings menu. Features marked with asterisks (*) are accessories.

Symbol description of the top row of the status screen (Fig. 3)

	Operating messages. Displayed if temporary service interruption occurs, this is not an error. Await. See Operating messages.
	Information. Flashes when there is an information message.
	230V. Electricity (230V) is connected to the boiler.
	Day Mode. Appears when the feature is on and turns green when it is active.
	Night Mode. Appears when the feature is on and turns green when it is active.
	LPG bottle full/empty*. Appears if a DuoControl is installed. Black bottle = Gas available. Red bottle = One bottle empty.
	EisEx*. Appears if EisEx is turned on and turns green when active.
	Engine heating*. Shown if the engine heater is installed and turned on and turns green when active.
	Anti-bacteria. The boiler's automatic bacterial elimination setting is running.
	High altitude mode. Flashes if the high altitude mode is active.
	Alde AquaClear UV-C*. Water filter.



Fig 3. Top row of status screen





	Indoor temperature shows the current temperature and whether the circulation pump is active (O). Tap the icon to change the desired temperature.
	Zone icons (dual zones). Displays the current temperature and whether the circulation pump is active in the zone (O). Tap the icon to change the desired temperature.
	Light*. Start, turn off, or dim the AC lighting (only with Truma AC)
	Energy. Shows the energy source used; the flame turns red when gas is in use and the flash turns yellow when electricity is in use. Tap the icon to select and prioritise energy source and to set load monitor* and high altitude mode.
	Hot water. Indicates whether hot water production is on, "boost" or turned off. Press the respective controls to start/switch off or increase hot water production. The thermometer fills up entirely when the hot water reaches boost temperature. See Hot water section.
	Outdoor temperature*. If an outdoor sensor is installed, the current outdoor temperature is displayed.



Fig 4. Main menus on the Status screen

Set the desired temperature

The temperature can be set from +5°C to 30°C in increments of 0.5°C. To set the temperature, press "Indoor" (single zone)/ "Respective zone" (dual zone). The temperature shown (Fig. 5) reflects the temperature currently set.

- To raise the temperature, press the plus button to the right of the temperature.
- Lower the temperature by pressing the minus button, to the left of the temperature.

You can leave the menu by clicking the Back arrow in the upper left part, or by pressing the "MENU" button once; the heating system works directly to reach the set temperature.



Fig 5. Set temperature

WARNING:

Scalding Hazard

When the hot water and glycol mixture in the boiler are heated at the same time, the hot water can become very hot in the event of a significant heating requirement.

Hot Water

In the boiler there is a built-in water heater with a capacity of about 8.5 litres. The boiler can be used even without fresh water being in the heater. There are three different settings for hot water: no hot water, normal operation and boost (prioritised hot water) Fig. 6

- No hot water or normal operation. Press the on/off button on the screen under hot water to switch between no hot water production and normal hot water production.



Fig 6. Set up hot water production

HOW TO USE YOUR MOTORHOME'S EQUIPMENT

- “Boost”, (prioritised hot water production). Tap the slider to the right of the text that reads “Boost 30 minutes”. The boiler will now prioritise the production of hot water for 30 minutes. After 30 minutes have passed, the boiler returns to its previous setting. Prioritised hot water production is recommended for increased hot water demand.

Energy sources

The boiler can be powered either by gas or electricity or both at the same time. The fastest heating is obtained by using both energy sources at the same time as the overall power available will be greater. Hence, more power, equals faster heating. It is also possible to prioritise which energy source to use, when both gas and electricity are switched on; in the event of high heat demand, both are activated. When the boiler approaches the set temperature, energy consumption is gradually reduced.



Fig 7. Choice of energy sources

Heating with electricity

The consumption selected in the menu is the maximum consumption permitted, i.e. the boiler does not use more power than is required, even if e.g. 3kW is selected in the Control Panel.

- Tap the “Max electricity” menu bar ⚡ to open the electric power settings menu.
- Increase or decrease the maximum permissible electrical power between 0-3 kW using the plus and minus buttons. 0 kW equals electric operation being switched off.
- Confirm your selection by pressing the “Set” button. Press “Cancel” to cancel.

Heating with gas

Tap the slider on the “Gas” menu bar 🔥 to start and shut off gas operation. (Fig 7).

High altitude mode

High altitude mode is only to be used if the boiler will be powered by LPG at altitudes exceeding 1000m above sea level. For high-altitude LPG operation, use propane to ensure stable combustion. Varied operating conditions at high altitudes may cause the boiler to not always reach full gas operation. Tap the slider on the “High altitude mood” menu bar ⚡ to start and turn off throttle. (Fig. 7)

HOW TO USE YOUR MOTORHOME'S EQUIPMENT

Settings menu

To reach the Settings menu from sleep/standby screen, press the "MENU" button. Features marked with asterisks(*) are accessories. The Settings menu provides the following features:





The Settings menu (Fig. 8)	
	Night Mode. Automatically changes select features during the night. Choose the time interval and whether it should be done every night or a specific night each week. The following can be changed: temperature, status screen light, putting AC* into night operation and changing AC sensors, turning off hot water production and underfloor heating*.
	Day Mode: Automatically changes select features throughout the day. Choose the time interval and whether it should be done every night or a specific night each week. The following can be changed: temperature and hot water production.
	AC* (Truma only). Start or turn off automatic climate setting (=AC and the heating system work together); for dual-zone installation, choose which zone the AC should follow.
	Underfloor heating*. Underfloor heating. Turn the underfloor heating on and off. Select continuous operation of the underfloor heating by activating "Continuous".
	Engine pre-heat*. Heat the engine using the Alde heating system. Start or turn off the function, select the start time and the engine heating duration.



Fig. 8 Settings menu





The Settings menu (Fig. 9)	
	EisEx, defroster for gas regulator. Prevents ice formation in the regulator during winter. Select on or off, and select whether EisEx should automatically turn on when it is cold. Automatic switch-on requires an outdoor sensor to be installed.
	Delayed start, automatic boiler start. Start or turn off the feature, select start and end time. For the function to work, the boiler must be switched off.
	External start. The function is used when starting the boiler from outside. When external startup is enabled, the panel should be turned off. External start has three modes: Off, External start and 230V. Off. The function is turned off. External start* The function is used when starting the boiler with external start, by switching the "Ext Start" connector on the boiler's circuit board. When the External Start function is activated, the control panel should be turned off but 12V is connected. 230V. The function is used to start the boiler by connecting 230V to the vehicle. When the 230V function is activated, the control panel should be switched off but 12V connected. Some vehicles may be equipped with their own solution (winter coupling).
	Temp sensor calib. offset for temperature sensor. If you feel that the temperature sensor should be slightly adjusted, the temperature can be adjusted by $\pm 5^{\circ}\text{C}$. Also applies to outdoor temperature sensor.



Fig. 9 Settings menu

The Settings menu (Fig. 9) continued	
	Display. Select panel brightness: Low, Medium or High. You can also choose whether the status screen should be Normal, Inverted or Dark. If Dark is selected, the panel will go dark after 30 seconds and will light up again if touched.





The Settings menu (Fig. 10)	
	Sound. Start or turn off button and warning/notification sounds.
	Language. Change the language in the Control Panel menus; available languages are: English, German and French.
	Service. Displays values from the heating system; these are updated continuously and describe the current status of the boiler. See Service Menu & Reset.
	System configuration, enable installed accessories and features. Here, you will find all accessories or functions that can be connected to the Alde Heating System; tick the features that are installed in the heating system to enable their use.
	Reset. Resets the panel to factory setting. The accessories/ features selected under System Configuration are not affected.



Fig. 10 Settings menu

Glycol fluid

The system must be filled with a fluid mixture consisting of distilled water and glycol. We recommend using a high quality premixed glycol (with inhibitors) intended for aluminium heating systems. When using concentrated glycol, the mixture must consist of 60% distilled water, or water with no salt content and 40% glycol. The use of tap water may cause corrosion and affect the warranty.

If the system is exposed to temperatures lower than -25°C , glycol content must be increased, but must not exceed 50%.

Note: If the glycol fluid is not replaced at appropriate intervals, there is a risk of frost damage, corrosion, bacterial growth and/or overheating.

The glycol mixture must be changed every two years, as properties such as corrosion protection degrade. If Alde Premium Antifreeze is used, the replacement period can be extended to max. 5 years of normal use.

Refill the heating system with glycol liquid Glycol content should be checked at the expansion vessel using a glycol tester before refill, to ensure that the concentration of glycol in the liquid is not too high. If the liquid level has dropped for reasons other than evaporation, check all joints, rubber hoses, drain taps and air screws for leakage before filling.

The glycol system is manually replenished in the expansion vessel. When manually filling, slowly pour the glycol mixture into the expansion vessel. The level must be approx. 1cm above the MIN. line (Fig. 11) when the system is cold.

If there are 2 zones, both zones must be vented in the system after filling. Top up if the glycol level drops after venting. Vent a newly-filled heating system regularly.

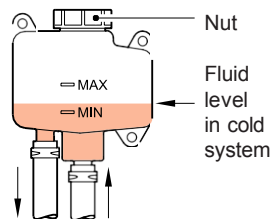

Fig. 11 Expansion Vessel

Service Information & Reset

Tap "Service Information" to get to the service menu (Fig. 12). Here, you will see values from the heating system (Fig. 13); the values are updated continuously.

Touch "Reset" (Fig. 12) to reset the Control Panel to factory settings. After resetting, the system will be set as follows:

- Heater - Off mode/Boiler - Off
- Max. electricity - 1 kW/Max. electricity - 1 kW
- Gas heating - On mode
- Target temperature - 22.0°C/Temperature setting - 22.0°C
- Hot water - In normal mode

All other functions will be switched off. The accessories/functions selected under "System configuration" are not affected by resetting.



Service and Reset



Service page 1

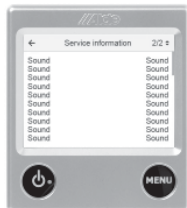

Service page 2

Fig. 12 Control Panel menus

Fig. 13 Service Information

For further information please refer to the Manufacturers operating instructions which are supplied with your vehicle.

HOW TO USE YOUR MOTORHOME'S EQUIPMENT

OVEN (ALL RANGES)

Safety

- This appliance may be used by children aged 8 years or older and persons with reduced physical, sensory or mental capabilities and/or lack of experience and knowledge only if they are supervised or have been given instructions on the safe use of this appliance and understand the potential hazards.
- Keep children younger than 8 years away from the appliance, except under constant supervision.
- Do not allow children to play with the appliance.
- Do not allow children to clean or maintain this equipment unattended.
- Use only parts supplied by the manufacturer.
- Do not change or adjust anything on the appliance, unless the change is authorised by the manufacturer or its representative.
- If the power cord is damaged, it must be replaced by the manufacturer, its service agent or similarly qualified persons in order to avoid a hazard.
- Use the appliance for cooking only and not for anything else, for example room heating. This can lead to carbon monoxide poisoning and overheating. The manufacturer cannot be held liable for damage resulting from improper use or incorrect setting of the controls.
- This appliance is not intended to be operated by means of an external timer or separate remote-control system.
- The use of this gas cooking appliance results in the production of heat, moisture and products of combustion in the room in which it is installed. Ensure the room has sufficient ventilation when the appliance is in use. During prolonged use, additional ventilation may be needed by opening a window or increasing the extraction force of the hood.

Never extinguish a cooking fire with water. Turn the burner off and cover the flame with a lid or a fire blanket.

- The appliance and its accessible parts become hot during use. Care should be taken to avoid touching heating elements.
- The cooking process must be supervised. A short term cooking process must be supervised continuously. Unattended cooking on a hob with fat or oil can result in fire. Do not leave the appliance unattended when in use.
- The use of inappropriate hob guards can cause accidents.
- Danger of fire, do not store items on the cooking surface of the hob.
- The burners and pan supports are hot during and after use. Allow all parts to cool before touching them, as this can cause serious injury.
- The food shelves and trays in the appliance are hot during and after use. Allow all parts to cool before touching them, as this can cause serious injury. Always use oven gloves when removing the shelves and trays.
- Do not store items in the appliance.
- Do not put heavy objects on the open appliance door.
- The appliance and accessible parts become hot when the grill is in use. Young children should be kept away.
- **CAUTION:** hot surfaces. Refer to manual for grill operation. Grill door must be open when grill is in use.

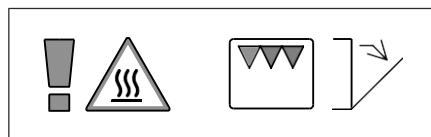

- In the event that abnormal drift in cooking temperature of the oven is observed, have the thermostat checked by a qualified service engineer.

HOW TO USE YOUR MOTORHOME'S EQUIPMENT

- Care should be taken not to overload the oven, allowing adequate spacing to ensure free circulation of heat.
- Do not use steam cleaners or pressure washers to clean the appliance. See Maintenance and Cleaning for instructions.
- Do not allow oil or fat to build up on the appliance. Clean the appliance after each use.
- Before cleaning or maintenance work the appliance must be left to cool and be disconnected from the gas and electrical supplies.
- The glass lid may snap shut towards the end of lowering due to the travel-lock action of the hinges. Make sure all fingers are clear of the appliance when closing the lid.
- Do not use harsh abrasive cleaners or sharp metal scrapers to clean the surface of the glass, since they can scratch the glass surface which may result in shattering of the glass.
- Remove any spillage from the glass lid before opening the lid.
- Do not shut the glass lid when the burners are lit or still warm.



Before using the appliance:

- Ensure that all packaging materials have been removed.
- Clean the appliance with warm water and household detergent and dry carefully with a soft cloth.
- Ensure that the gas supply is connected and turned on.
- Ensure that the appliance is connected to the 12V DC battery for the cooling fans and spark ignition.
- Ensure that the pan supports are positioned properly.
- Ignite the gas burners and let them burn to expel odours and vapours first.
- Ignite the burner and heat the grill for about 20 minutes to eliminate any residual factory lubricants that might impart unpleasant smells to the food being cooked. Smoke may occur during this procedure. Open any windows and turn on mechanical ventilators to help remove the smoke.
- Ignite the burner and heat the oven for about 30 minutes at 200°C to eliminate any residual factory lubricants that might impart unpleasant smells to cooked food. Smoke may occur during this procedure. Open any windows and turn on mechanical ventilators to help remove the smoke.

Dual Fuel only:

- Ensure the electricity is connected and switched on.
- Prime the hotplate by switching on the hotplate for a short period, without a pan, to harden and burn off the coating. Use a medium to high setting for 3-5 minutes. Allow adequate ventilation to disperse any smoke that occurs during this process. Allow the hotplate to cool.
- Season the hotplate by heating the hotplate for 30 seconds on a medium setting and then switching off. Pour a minimal amount of unsalted vegetable oil onto a clean dry cloth or paper towel and apply a thin coat of oil to the hotplate

HOW TO USE YOUR MOTORHOME'S EQUIPMENT

surface. Wipe off any excess oil, then heat the hotplate on a medium setting for 1 minute. Occasional seasoning will help to maintain the hotplate's appearance.

Only use LPG (Liquefied Petroleum Gas). The appliance operates on propane or butane. Propane is preferred over butane, because butane provides poor performance at an ambient temperature below 10°C and cannot be used at an ambient temperature below 5°C.



Oven shelf: (Applies to K1520 only)

- The oven shelf allows good circulation at the rear of the oven.
- A raised bar at the rear of the shelf prevents trays or dishes making contact with the back of the oven.
- To remove a shelf, pull it forward until it stops, raise at the front and remove.
- The oven shelf allows good circulation at the rear of the oven.

Only use LPG (Liquefied Petroleum Gas). The appliance operates on propane or butane. Propane is preferred over butane, because butane provides poor performance at an ambient temperature below 10°C and cannot be used at an ambient temperature below 5°C.



Cooling system: (Applies to K1520 only)

This appliance is fitted with an automated cooling system.

- The cooling fan will automatically switch on a few minutes after the grill and/or oven is turned on and will remain on even after the appliance has been switched off.
- The fan will automatically switch off a few minutes after the appliance has been switched off, when the appliance has cooled sufficiently.
- When either the grill or oven is first lit or after switching off, the cooling fan may operate intermittently, this is normal.

Maintenance and cleaning

Theford recommends an annual inspection service by an approved service centre. Between annual servicing, clean the appliance regularly after use. Before any cleaning work is started, the appliance should have been left to cool and be disconnected from the gas and/or electrical supplies.

- Always remove any spills or contamination immediately after use with soap and hot water. Towel dry the surface with a soft cloth.
- Use a non-abrasive multi-purpose cream cleaner and a nylon scourer pad to clean more stubborn dirt or grease.
- Use a proprietary stainless steel cleaner or polish to remove superficial surface scratching.
- Do not use abrasive cleaners, metal scouring pads or hard brushes. They could damage the appliance.
- If you clean the burner rings, ensure that the holes are not clogged.
- Do not use harsh abrasive cleaners or sharp metal scrapers to clean the glass surface, since they can scratch the glass surface which may result in shattering of the glass.
- Do not leave wet cloths, cleaning pads, residues of food or cleaning products or other dirt to dry on the surface. It can cause pitting, marking or even rusting.
- Always clean in the direction of the brushed finish and not across the grain.
- Cleaning agents containing bleach should not be left in contact with stainless steel.
- Mineral content in water (such as iron or limescale) can affect the appearance of the metal.
- Remove any spillage from the glass lid before opening the lid.
- The control knobs can be removed for cleaning. The knobs are easy to replace.

HOW TO USE YOUR MOTORHOME'S EQUIPMENT

Troubleshooting

Problem	Possible cause	Solution
Burners do not burn or burn unevenly	Gas bottle is empty Gas tap is closed Burner caps are not correctly positioned Burners are wet or clogged	Change gas bottle Open tap Allow caps to cool, then reposition them Dry or clean burners
Spark ignition does not spark	12V DC battery is discharged Connections are loose Ignition points are wet or dirty	Charge battery Secure connections Dry or clean ignition points
Control knobs do not function	Knobs are mounted incorrectly	Install knobs correctly

If you cannot solve a problem, contact the authorised local Service Centre or Thetford Customer Service in your country.

HOW TO USE YOUR MOTORHOME'S EQUIPMENT

K1520

Main Components

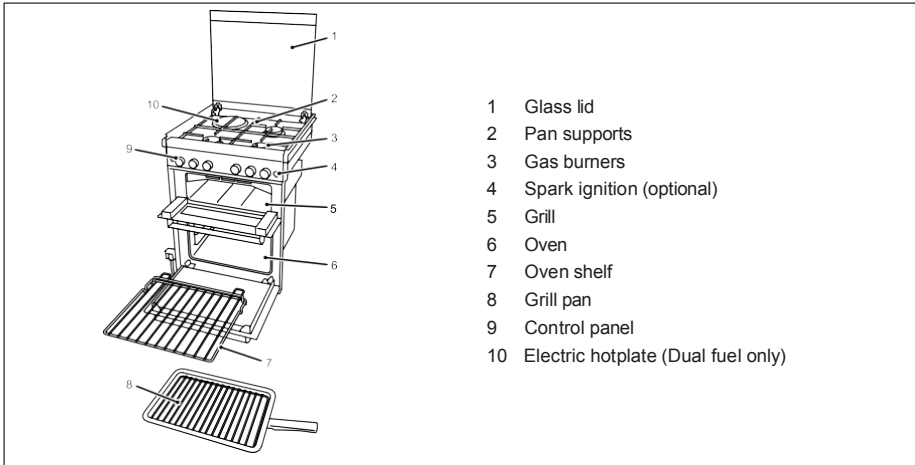

The types of burners may vary depending on the type of appliance. Refer to Technical specifications for further details.

Use of the burners

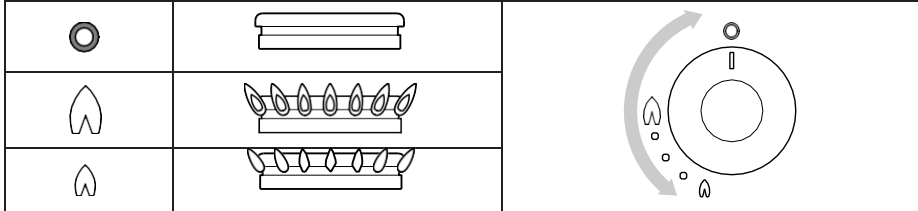

For the exact location of the control knobs, see Main components.

Turning on:

- Push and turn the control knob.
- Turn the control knob anti-clockwise to the full rate position.
 - For spark ignition models: Push the ignition button.
 - For non-ignition models: Hold a lit match or gas match to the burners.
- Keep the control knob pressed for about 10-15 seconds and then release it.
- Adjust the height of the flame.



If the burner accidentally extinguishes turn the control knob to the 0 position and wait at least 1 minute before re-igniting the burner.



If the burner has not lit within 15 seconds turn the control knob back to the 0 position and release it. Wait at least 1 minute and repeat the steps above to turn on the appliance.

Turning off:

- Turn the control knob clockwise to the 0 position to turn off the burner.



Always make sure the control knob is in the 0 position when you have finished using the gas burners.



Do not shut the glass lid when the burners are lit or still warm.

Use of the electric hotplate (if applicable)

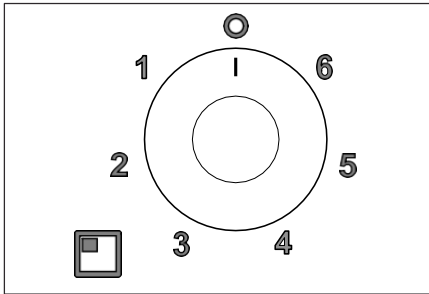

For the exact location of the control knob, see Main Components:

Turning on:

- Rotate the control knob either clockwise or anti-clockwise to the required position (1-6).

For maximum efficiency, a correctly sized pan with a flat heavy gauge base should be used. The pan size should be the same or slightly larger than the hotplate (up to 1"/2.5cm oversize).

Turning off:

- Turn the control knob to the 0 position to turn off the hotplate.



Always make sure the control knob is in the off position when you have finished using the hotplate.



Do not shut the glass lid when the hotplate is turned on or still warm.

Use of the grill

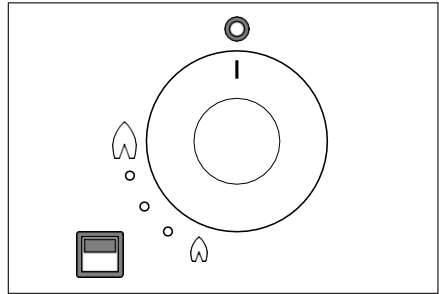

For the exact location of the control knob, see Main components.

Turning on:

- Open the door and push the control knob.
- Continue pressing the control knob and turn it anti-clockwise to the full rate position.
 - For spark ignition models: Push the ignition button.
 - For non-ignition models: Hold a lit match or gas match to the burner.
- Keep the control knob pressed for about 10-15 seconds and then release it.
- Adjust the required heat setting.
- Depending on the food to be cooked, the correct grilling height can be achieved by inverting the pan trivet into either the high or low position.
- The grill pan supplied is multi-functional, for use in grill or oven and the handle design allows removal or insertion whilst the pan is in use. Always remove the handle when the pan is in use.



The grill door must remain open when lighting and using the grill.



If the burner accidentally extinguishes, turn the control knob to the 0 position and wait at least 1 minute before re-igniting the burner.



If the burner has not lit within 15 seconds turn the control knob back to the 0 position and release it. Wait at least 1 minute and repeat the steps above to turn on the appliance.

HOW TO USE YOUR MOTORHOME'S EQUIPMENT

- Although the grill heats up quickly, it is recommended that a few minutes preheat be allowed. A 12 Volt cooling fan operates automatically above the grill cavity.
- It is normal for the flames on this burner to develop yellow tips as the grill heats up.

Turning off:

- Turn the control knob clockwise to the 0 position to turn off the grill.



Always make sure the control knob is in the 0 position when you have finished using the grill.

Use of the oven

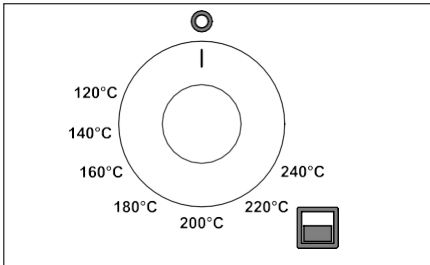

For the exact location of the control knob, see:

Turning on:

- Open the door and push in the control knob.
- Continue pressing the knob and turn it anti-clockwise to the full rate position. (240°C, gas mark 7/9).
 - For spark ignition models: Push the ignition button.
 - For non-ignition models: Hold a lit match or gas match to the burner.
- Keep the control knob pressed for about 10-15 seconds and then release it.
- Adjust the required heat setting.
- Place the oven shelf in the required position and close the door.



Ignition must always be carried out with the oven door open.



If the burner accidentally extinguishes turn the control knob to the 0 position and wait at least 1 minute before re-igniting the burner.



If the burner was not lit within 15 seconds turn the control knob back to the 0 position and release it. Wait at least 1 minute and repeat the steps above to turn on the appliance.

Although the oven heats up quickly, a 10-minute preheat is recommended. The oven should reach full temperature in about 15-20 minutes.

Turning off:

- Turn the control knob clockwise to the 0 position to turn off the burner.



Always make sure the control knob is in the 0 position and the oven door is closed when you have finished using the oven.

Safe cooking

- Do not allow cooking vessels to overlap the edges of the appliance - use the correct sizes of pans and position them centrally over the burners.

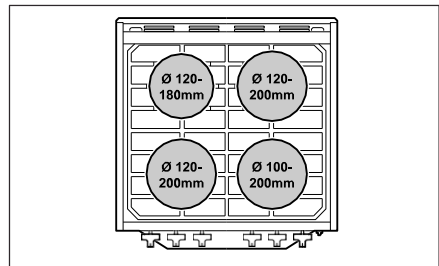
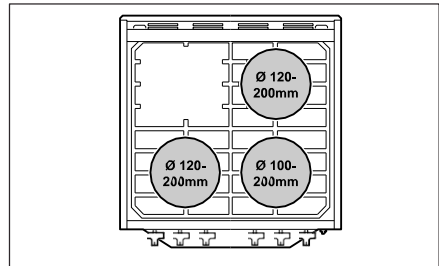

HOW TO USE YOUR MOTORHOME'S EQUIPMENT

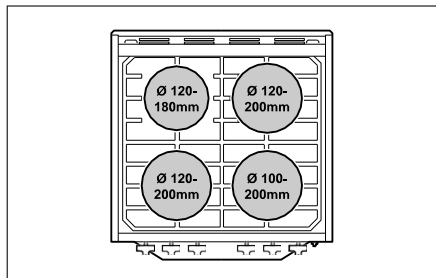

- Ensure that there is at least a 10mm gap between the pans and the edges of the hob.
- Turn the pans so that the handles do not overhang the front of the appliance.
- Ensure that the flame of the gas burner heats the bottom of the pan, not the sides.
- The pans and trays supplied with this appliance are the maximum sizes. Do not use larger pans and trays. They may

restrict good circulation of heat, which may increase cooking times.

- Do not leave the appliance unattended when in use.
- Do not use the appliance while the vehicle is moving.
- Turn the control knob back to the 0 position after cooking.
- Keep the appliance clean and prevent accumulation of grease and food scraps.



Never cover slots or holes in the appliance and never cover a shelf with materials such as aluminium foil. That restricts the airflow and may cause carbon monoxide poisoning.





The food shelves and trays in the appliance are hot during and after use. Allow all parts to cool before touching them, as this can cause serious injury. Always use oven gloves when removing the shelves and trays.

Temperature control

The temperature in the oven is controlled by a thermostatic gas tap and is variable over the range 130°C to 240°C.

The table provides a guide to the approximate temperatures at each of the shelf positions with respect to the gas mark setting. Good use can be made of the temperature variation between the shelf positions, as several dishes requiring different temperatures may be cooked at the same time. In this way maximum benefit can be obtained from the gas used to heat the oven.

Table 1: Temperature zones

Gas Mark				Dish
1/4 - 1/2	90°C	110°C	130°C	Meringues
1	110°C	130°C	150°C	Stewed fruit
2	120°C	140°C	160°C	Rich fruit cake, rice pudding
3	130°C	150°C	170°C	Baked custard, shortbread finger
4	140°C	160°C	185°C	Victoria sponge
5	155°C	180°C	200°C	Whisked sponges, ginger nuts
6	170°C	190°C	215°C	Short crust pastry
7	185°C	210°C	230°C	Bread, scones, flaky pastry
8	200°C	220°C	245°C	Puff pastry
9	200°C	220°C	245°C	Puff pastry



Care should be taken not to overload the oven, allow adequate spacing to ensure free circulation of heat.



When roasting with aluminium foil ensure the foil does not impair circulation of heat or block any oven flue outlet.

REFRIGERATOR

(RM 8400/RMS 8400 WHERE FITTED)

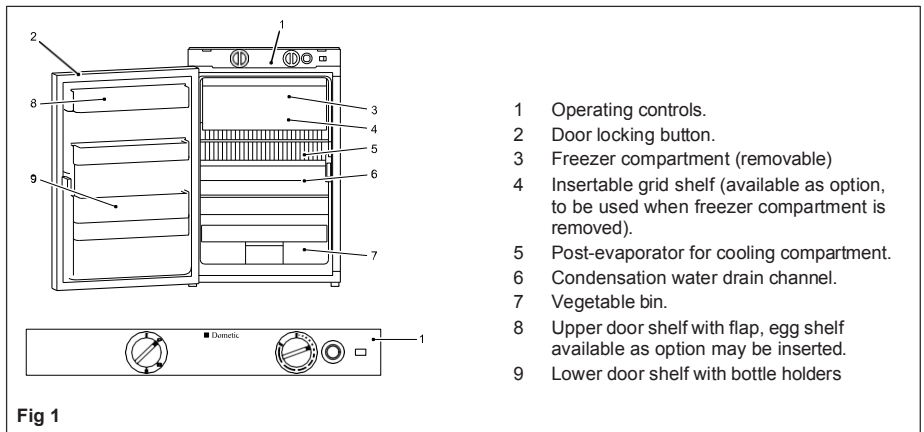

The refrigerator is equipped to operate on three power modes:

- Mains voltage (230V AC)
- Direct current voltage (12V DC)
- Gas (liquid gas, propane/butane)

Select the desired power mode by the energy selector switch (battery igniter type models) or the energy selector button (MES, AES). Appliances with automatic energy selection (AES) are additionally provided with "automatic mode" function. Then the AES system automatically selects the best energy source for each particular situation.

The cooling unit is silent in operation.

When the appliance is first put into operation, there may be a mild odour which will disappear after a few hours.

The refrigerator will take several hours to reach its operating temperature in the cooling compartment. The freezer compartment should be cold about one hour after switching on the refrigerator.

Cleaning

Before starting up the refrigerator, it is recommended that you clean it inside and repeat this at regular intervals.

Use a soft cloth and lukewarm water with a mild detergent. Then wipe out the appliance with clean water and dry thoroughly.

To avoid material alterations, do not use soap or hard, abrasive or soda-based cleaning agents. Do not allow the door seal to come into contact with oil or grease.

Maintenance

In compliance with applicable regulations, please note that the gas unit and the connected ventilation ducts must be checked by an authorised technical personnel after first use and after every other year for compliance with the European Standard EN 1949. A test certificate has to be issued. **It is the user's responsibility to arrange this test.**

The gas burner must be inspected and cleaned as necessary, at least once a year. When using liquefied petroleum gas (tank or refill cylinders) the maintenance interval is reduced to half-yearly or quarterly.

Keep the evidence of maintenance work carried out on your refrigerator.

HOW TO USE YOUR MOTORHOME'S EQUIPMENT

Work on gas and electrical equipment shall be carried out by qualified personnel only.

It is recommended that this is carried out by an authorised customer services department.

We recommend maintenance following an extended shutdown of the vehicle. Please contact our customer services.

Electrical operation

12V voltage (on-board power supply)

CAUTION: The refrigerator should only be used in 12V DC operation while the vehicle's engine is running, otherwise the on-board battery would be discharged within a few hours!

Appliances with battery igniter (manual energy selection)

Electrical operation

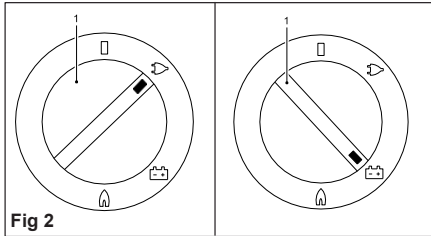



Switch on the appliance by turning the energy selection switch (1) clockwise to position:

 230V operation,

 12V operation

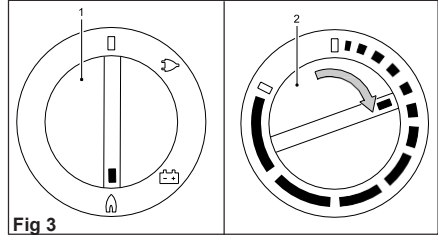
Gas operation (Liquid gas)



1. Turn the rotary selector switch (1) to position 
2. Turn the temperature selector (2) clockwise and push. Keep the controller button depressed.

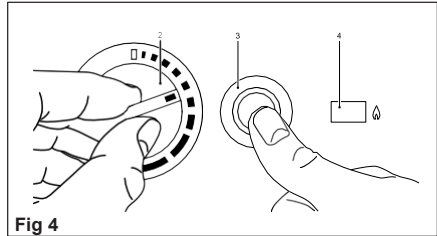

3. Then, press knob (3) of battery igniter down and keep it depressed. The ignition process is activated automatically.
4. Once the flame ignites, the pointer of galvanometer (4) begins moving into the green range. The refrigerator is operational. Keep knob (2) depressed for approx. 15 seconds and finally release it.

Setting of cooling compartment temperature

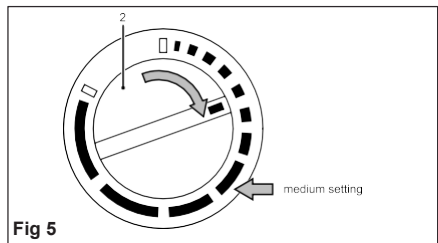

Select the desired cooling compartment temperature by turning the rotary knob (2).

HOW TO USE YOUR MOTORHOME'S EQUIPMENT

The scale starts with **MIN** position (small bar = highest temperature) and climbs up to **MAX** position (large bar = lowest temperature).

Note: The temperature levels do not relate to absolute temperature values.

12V: The refrigerator operates without thermostatic control (continuous operation).

Mains power (230V)

CAUTION: This option should only be selected where the supply voltage of the connection for power supply corresponds to the value specified on the data plate. Any difference in values may result in damage to the appliance.

Gas operation (Liquid gas)

- The refrigerator must be operated using liquid gas (propane, butane) (no natural gas or town gas).
- When using LPG gas, please consider that the burner needs cleaning at shorter intervals due to the gas combustion method (2-3 times per year recommended).
- In Europe, gas operation is permitted while travelling only on the condition that the gas system of the vehicle is equipped with a hose rupture protection. The national regulations of the respective country must be observed.
- For physical reasons, gas ignition faults could occur starting from an altitude above sea level of approx. 3280 ft. / 1000m (No malfunction).
- On the initial refrigerator start-up or after a cylinder change, air may be trapped in the gas line. To purge the air from the lines, switch on the refrigerator and any other gas appliances (e.g. stove) for a short time. The gas ignites without delay.
- Each refrigerator with manual ignition is equipped with an automatic flame safety valve which interrupts the gas supply automatically after approx. 30 seconds when the flame has extinguished.

WARNING: As a basic rule, gas operation is prohibited in petrol stations!

Prior to starting the refrigerator in gas mode:

- Open the gas cylinder valve.
- Open the shut-off valve for gas supply to the refrigerator.

Explanation of operating controls

Manual energy selection/manual ignition battery igniter:

- 1 = Power On switch/Energy selector switch
- 2 = Temperature controller
- 3 = Battery igniter (gas)
- 4 = Flame indicator (galvanised)

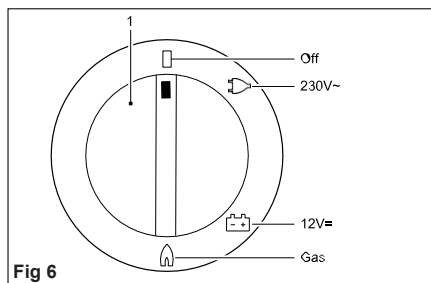

Fig 6

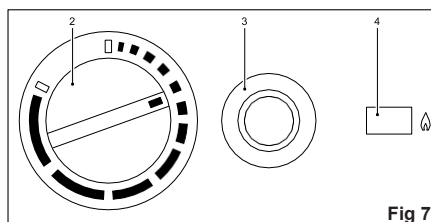

Fig 7

HOW TO USE YOUR MOTORHOME'S EQUIPMENT

Door locking

Open the door by pressing the locking button and pull open.

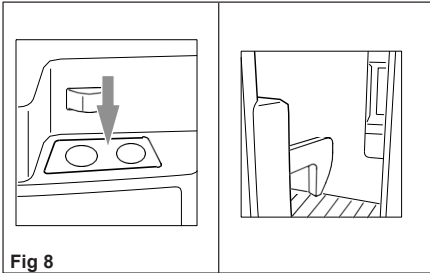

Fig 8

Shut the door again by pushing it to close. The snapping into the lock can be heard.

Note: If the vehicle is stationary for a long period, the locking hook may be clamped by means of a lockbar. The door may now be opened by just pulling it without need of pressing the locking button. See below.

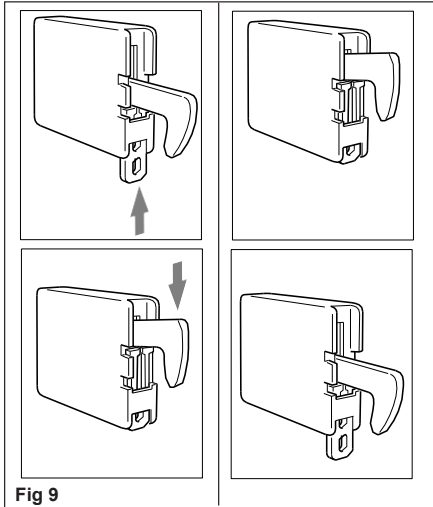

Fig 9

CAUTION: As a basic rule, shut and lock the door before starting your journey.

Positioning the shelves

The shelves may be pulled out by smoothly lifting them, and may be positioned as desired.

Removable freezer compartment

The freezer compartment may be removed to enlarge the cooling compartment.

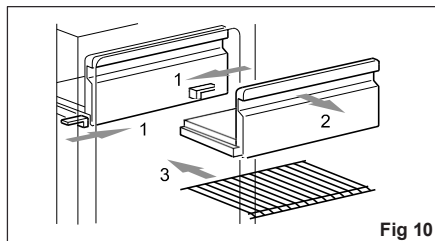

Fig 10

Unlock the freezer compartment on both sides (1)

Pull the freezer compartment out (2) and store safely.

An additional shelf (3) may be installed, if required. This may be obtained from Dometic.

Storing food in the cooling compartment

- Switch the refrigerator on approx 12 hours before filling
- Always store pre-cooled food. Make sure that food is well cooled when it is bought and also when transporting it – use insulated cool bags.
- Keep the door open for the minimum time possible.
- Food must be packed, in closed containers or wrapped in foil, and stored separately from each other, to prevent drying out or odours.
- Allow foods that have been warmed to cool down before storing.
- Ensure that air circulation of the cooling unit is not obstructed. Keep the ventilation grilles free from obstructions.

Storing food in the freezer compartment

- Do not keep carbonated drinks in the freezer.
- The freezer compartment is suitable for making ice cubes and for short term storage of frozen foods. It is not suitable as a means of freezing foods.

Note: When ambient temperatures are lower than +10°C and the refrigerator is exposed to these temperatures for extended periods an even regulation of freezer temperature cannot be guaranteed for system-related reasons. This can cause the temperature in the freezer to rise and stored goods to melt.

Making ice cubes

Ice cubes are best made over night, when the refrigerator has less work to do and has more reserves.

Defrosting

In time, frost builds up on the fins inside the refrigerator. A layer of frost thicker on one side may occur but does not mean a malfunction. When this layer of frost is about

3mm thick, the refrigerator should be defrosted. To do this:

- Switch off the refrigerator as described later.
- Remove all food and the ice cube tray.
- Leave the door open to allow air to enter and prevent formation of mildew.
- After defrosting (freezer compartment and fins free of frost), wipe both cooling compartments dry with a cloth.

Note: Water thawing in the main compartment of the refrigerator runs into a container at the back of the refrigerator, from where it evaporates.

CAUTION: The layer of ice must never be removed forcibly, nor may defrosting be accelerated using a heat source.

Shutting off the refrigerator

Press the mode button (1) and keep pressed for 2 seconds. The display will disappear and the appliance is fully switched off.

Release the locking mechanism of the door lock by pushing it and shift it to the front. If the door is shut in this position, a small gap is maintained to prevent the formation of mildew.

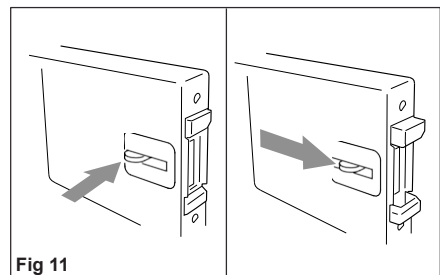

If the refrigerator is taken out of service for an extended period, close the isolation tap and the gas cylinder valve.

HOW TO USE YOUR MOTORHOME'S EQUIPMENT





Winter operation

In winter, check that the ventilation grilles and the exhaust duct have not been blocked by snow, leaves etc. When the outside temperature falls below +10°C the winter covers should be fitted. This protects the unit from excessively cold air which could have adverse effects on the performance of the unit.

Note: The winter covers should also be attached if the vehicle is taken out of service for an extended period, or while it is being cleaned on the outside.

Failure display

Your refrigerator will indicate a malfunction by flashing of the failure indicator LED (4) and one of the other display lights. The chart below shows the meaning of these.

Display:	Failure:
 LED is flashing	230V mode: "230V" not available or voltage too low
 LED is flashing	12V mode: "12V" not available or voltage too low
 LED is flashing	GAS/Auto mode: Flame not ignited
All temperature setting LEDs are flashing	Temperature sensor defective, refrigerator work on mid temperature setting
 LED + all temperature	230V - Heating element defective
 LED + all temperature	12V - Heating element defective setting LEDs are flashing

Troubleshooting

Before contacting your dealer or authorised service centre, please check whether:

- The instructions for correct operation of the refrigerator have been observed.
- The refrigerator is standing level.
- It is possible to operate the refrigerator with any available power source.

Failure: The refrigerator does not cool sufficiently

<i>Possible cause</i>	<i>Action you can take</i>
<ul style="list-style-type: none">• Inadequate ventilation to the unit.	<ul style="list-style-type: none">• Check that the ventilation grilles are not covered.
<ul style="list-style-type: none">• Thermostat setting is too low.	<ul style="list-style-type: none">• Set thermostat to a higher level.
<ul style="list-style-type: none">• The condenser is heavily frosted.	<ul style="list-style-type: none">• Check that the refrigerator door closes properly.
<ul style="list-style-type: none">• Too much warm food has been stored storage. within short period of time.	<ul style="list-style-type: none">• Allow warm food to cool down before
<ul style="list-style-type: none">• The appliance has been running for only works a short period of time.	<ul style="list-style-type: none">• Check whether the cooling compartment after approx. 4-5 hours.
<ul style="list-style-type: none">• Ambient temperatures too high.	<ul style="list-style-type: none">• Regularly remove ventilation grilles.

Failure: The refrigerator does not cool in gas operation mode

<i>Possible cause</i>	<i>Action you can take</i>
<ul style="list-style-type: none">• Gas cylinder empty.	<ul style="list-style-type: none">• Change gas cylinder.
<ul style="list-style-type: none">• Is the upstream shut-off device open?	<ul style="list-style-type: none">• Open shut-off device.
<ul style="list-style-type: none">• Air in the gas pipe?	<ul style="list-style-type: none">• Switch off the appliance and start again. Repeat this procedure 3-4 times, if necessary.

Failure: The refrigerator does not cool in 12V operation

<i>Possible cause</i>	<i>Action you can take</i>
<ul style="list-style-type: none">• On-board fuse defective.	<ul style="list-style-type: none">• Fit new fuse.
<ul style="list-style-type: none">• On-board battery discharged.	<ul style="list-style-type: none">• Check battery, charge it.
<ul style="list-style-type: none">• Engine not running.	<ul style="list-style-type: none">• Start engine.
<ul style="list-style-type: none">• Heating element defective (please also Customer refer to failure indication).	<ul style="list-style-type: none">• Please inform the Dometic Services.

HOW TO USE YOUR MOTORHOME'S EQUIPMENT

Troubleshooting (continued)

Failure: The refrigerator does not cool in 230V operation

Possible cause

Action you can take

- | | |
|------------------------------------------------------------------------|------------------------------------------------|
| • On-board fuse defective. | • Fit new fuse. |
| • Vehicle not connected to mains supply voltage. | • Make a connection to a mains power supply. |
| • Heating element defective (please also refer to failure indication). | • Please inform the Dometic Customer Services. |
-

HOW TO USE YOUR MOTORHOME'S EQUIPMENT

RML10.4S/RMD10.5X/RMS10.5XS (Where Fitted)

Safety when operating

CAUTION: Failure to obey these cautions could result in minor or moderate injury.

Health Hazard

- Make sure that you only put items in the device which may be chilled at the selected temperature.
- Opening the door for long periods can cause significant increase of the temperature in the compartments of the device.
- Food may only be stored in its original packaging or in suitable containers.
- Store raw meat and fish in suitable containers in the device, so that it is not in contact with or drip onto other food.
- If the device is left empty for long periods:
 - Switch off the device.
 - Defrost the device.
 - Clean and dry the device.
 - Leave the door open to prevent mould developing within the device.

Risk of Injury

- The device door or the freezer door can completely detach from the device if used incorrectly. Push the doors closed until you hear a clear click at the top and bottom.
- Do not lean on the open device door.

Damage Hazard

- If the door is not locked correctly on the opposite side, push on that side at the top and bottom until it locks in place.
- Only store heavy objects such as bottles or cans in the device door, in the vegetable compartment or on the bottom shelf.

Intended Use

The device is suitable for:

- Installation in caravans and motorhomes.
- Cooling, deep-freezing and storing food.

The device is **not** suitable for:

- Storing medications
- Storing corrosive substances or substances that contain solvents
- Quick-freezing food

The refrigerator is an absorber refrigerator and is designed for operation









- on a DC power supply (12V)
- on an AC power supply
- with liquefied gas (propane or butane)

The refrigerator has an automatic operating mode that selects the most economical type of energy connected. The refrigerator unit operates silently.

HOW TO USE YOUR MOTORHOME'S EQUIPMENT

Operating and display elements

The LED display features the following operating and display elements

Symbol	Description
	ON/OFF button
	Fault indicator
	Operation with DC power
	Operation with gas
	Operation with AC power
A	Automatic mode
	Temperature indicator
	Energy selection button
	Temperature selection button

Using the refrigerator

Note:

- Before starting your new refrigerator for the first time, clean it inside and outside with a damp cloth for hygiene reasons.
- When using the refrigerator for the first time, there may be a mild odour which will disappear after a few hours. Air out the living space well.
- Park the vehicle so that it is level, especially when starting up and filling the refrigerator before setting off on a journey.
- The cooling capacity can be affected by:
 - the ambient temperature (e.g. when the vehicle is exposed to direct sunlight)
 - the amount of food to be refrigerated
 - how often you open the door



Tips for optimal refrigerator operation

- Do not store goods in the refrigerator for the first 12 hours after start-up.
- Protect the interior of the vehicle from warming up excessively (e.g. sunshades in the windows, air conditioner).

Protect the refrigerator from direct sunlight (e.g. sunshades in the windows).

Operating the refrigerator

Controls

- Repeatedly press , until the LED indicates the desired operating mode.
- Repeatedly press  until the desired temperature level is set.

Tank stop mode

WARNING: Turn off the refrigerator or select a different operating mode if refuelling takes longer than 15 minutes.

If the vehicle's ignition is switched off, the refrigerator will switch to tank stop mode for safety reasons. This blocks gas operation for 15 minutes. The refrigerator then automatically switches back to the standard automatic mode.

Setting the cooling capacity

Note: For ambient temperatures of +15°C to +25°C, select the average cooling capacity.

Set the cooling capacity:

Repeatedly press  until the desired temperature level is selected.

HOW TO USE YOUR MOTORHOME'S EQUIPMENT

Troubleshooting

Fault	Possible cause	Suggested remedy
In AC power mode: The refrigerator does not work.	The fuse in the AC power supply is defective.	Replace the fuse.
	The vehicle is not connected to the AC power supply.	Connect the vehicle to the AC power supply.
	The AC heating element is defective.	Contact an authorised customer service point.
In DC power mode: The refrigerator does not work.	The fuse in the DC cable is defective.	The fuse on the relay must be replaced. Contact an authorised customer service point.
	The vehicle fuse has blown.	Replace the vehicle fuse. (Please refer to the operating manual of your vehicle).
	The vehicle battery is discharged.	Test the battery and charge it.
	The ignition is not switched on.	Switch on the ignition.
	The DC heating element is defective.	Contact an authorised customer service point.
In gas mode: The refrigerator does not work.	The gas cylinder is empty.	Replace the gas cylinder.
	The gas valve is closed.	Turn the valve to open.
	Air is in the gas line.	Switch the refrigerator off and on again. Repeat the procedure three or four times if necessary. If installed, switch on the stove and repeat the process on the refrigerator if necessary.
In automatic mode: The refrigerator is being operated with gas although it is connected to the AC power supply.	The grid voltage is too low.	The refrigerator automatically switches back to AC power supply as soon as the grid voltage is sufficient again.

HOW TO USE YOUR MOTORHOME'S EQUIPMENT

Troubleshooting

Fault	Possible cause	Suggested remedy
The refrigerator is not cooling adequately.	The ventilation around the cooling unit is not sufficient.	Check that the ventilation grille is not obstructed.
	The evaporator is iced up.	Check whether the refrigerator door closes properly. Make sure that the refrigerator seal fits correctly and is not damaged. Defrost the refrigerator.
	The temperature is set too high.	Set a lower temperature.
	The ambient temperature is too high.	Remove the ventilation grille for a while so that warm air can escape quicker.
	Too much food was placed in the refrigerator at the same time.	Remove some of the food.
	Too much warm food was placed in the refrigerator at the same time.	Remove the warm food and leave it to cool down before putting it in again.
	The refrigerator has not been operating for very long.	Check the temperature again after four or five hours.

Fault messages and signal tones

All faults are indicated by a warning symbol, a fault ID and a beep. The beeping lasts for 2 minutes and is repeated every 30 minutes until the error has been rectified.





If multiple faults occur, the display shows the most recent fault. The underlying faults are displayed after the last fault has been confirmed.

In the event of a fault, the LED warning symbol () in the display lights up continuously and the LEDs flash according to the fault.

HOW TO USE YOUR MOTORHOME'S EQUIPMENT

Warning type fault messages

All faults of the WARNING type are reset automatically once the fault has been rectified.

Fault	Solution
 Defective temperature sensor in the refrigerator compartment	Contact an authorised customer service point.
 AC power not connected or AC voltage <190V	Connect the refrigerator to AC power or select a different energy type, e.g. gas or DC power
 DC power not connected.	Connect the refrigerator to DC power or select a different energy type, e.g. gas or AC power.
 DC overvoltage (>16V)	Reduce the DC supply voltage.
 Tank stop mode: Gas operation is blocked for 15 minutes.	Wait 15 minutes or switch to another operating mode.
Beep The door has been open for more than 2 minutes.	Close the door.















Error type fault messages

All faults of the ERROR type must be reset manually:



Press  for 2 seconds

- ✓ A beep sounds
- ✓ The error has been reset.

HOW TO USE YOUR MOTORHOME'S EQUIPMENT

	Fault	Solution
	No connection between power module and display	Contact an authorised customer service point.
 	No cooling capacity in gas mode	Check if the device is at an angle and adjust it so it is level, if necessary. Reset the error. Contact customer service if this error occurs again.
 	No cooling capacity in AC power mode	Check if the device is at an angle and adjust it so it is level, if necessary. Reset the error. Contact customer service if this error occurs again.
 	No cooling capacity in DC power mode	Check if the device is at an angle and adjust it so it is level, if necessary. Reset the error. Contact customer service if this error occurs again.
 	Gas valve test error	Gas operation is not possible. Reset the error. Contact customer service if this error occurs again.
 	Internal communication error	Gas operation is not possible. Reset the error. Contact customer service if this error occurs again.
 	In stand-alone gas mode: The battery charge of the battery packs is too low	Insert new batteries and then reset the error.
	Gas lock after 3 ignition attempts	Ignition is not possible. The gas cylinder is empty. Replace the gas cylinder. Reset the error.

HOW TO USE YOUR MOTORHOME'S EQUIPMENT

Fault	Solution
 <p>Gas lock, internal error in the power module.</p>	<p>Reset the error.</p> <p>Contact customer service if this error occurs again.</p>
 <p>Ground contact, gas valve</p>	<p>Reset the error.</p> <p>Contact customer service if this error occurs again.</p>
 <p>Ground contact, ignition electrode</p>	<p>Reset the error.</p> <p>Contact customer service if this error occurs again.</p>

Cleaning and maintenance

WARNING: Always disconnect the refrigerator from the energy supply before cleaning and servicing it.

Note: When cleaning, never use sharp cleaning agents or hard or pointed tools to remove layers of ice or to loosen objects which have frozen in place.

- Clean the refrigerator regularly and when it gets dirty use a damp cloth.
- Make sure that no water drips into the seals. This can damage the electronics.
- Wipe the refrigerator dry with a cloth after cleaning.
- Check the condensate drain regularly. Clean the condensate drain when necessary. If it is blocked, the condensate collects on the bottom of the refrigerator.
- Make sure that the ventilation grilles in the outer wall of the motorhome and the refrigerator roof ventilator are free from dust and pollutants. This ensures that the heat generated during operation can dissipate, the refrigerator is not damaged and the cooling capacity is not reduced.

Cleaning the gas burner

WARNING:

- **Allow the burner to cool down before cleaning it.**
- **Do not modify the gas equipment.**

Note:

- Dirt in the gas burner is indicated by poor ignition or deflagrations.
- The manufacturer also recommends cleaning the burner after it has not been used for an extended period and at least once a year.
- When using liquefied petroleum gas, the cleaning interval is reduced to half yearly or quarterly, depending on the level of dirt.

Maintenance

WARNING: Work on gas and electrical installations may only be performed by qualified technicians.

- Have the gas system and connected flues inspected before starting up the device for the first time and by an authorised professional every two years to ensure they comply with the national safety requirements.
- Keep a record of any maintenance performed.

HOW TO USE YOUR MOTORHOME'S EQUIPMENT

MICROWAVE (Where fitted)

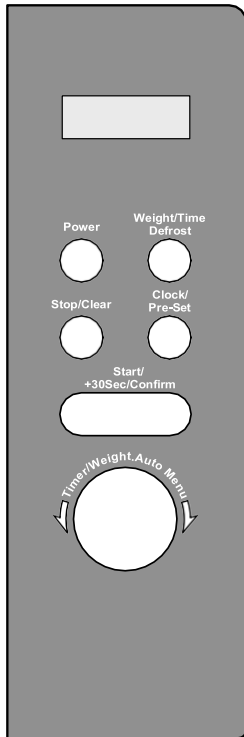

MENU ACTION SCREEN Cooking time, power, auto and the clock time are displayed.

POWER Press to select the power level for microwave cooking.

WEIGHT/TIME DEFROST Press this button to input weight for defrosting.

CLOCK/PRE-SET Press this button to input weight for defrosting.

STOP/CLEAR Press to stop the cooking process.

TIMER/WEIGHT . AUTO MENU Rotate to select the cooking time and the auto menus.

START/+30SEC/CONFIRM Press this button to start the cooking process and confirm when programming.

DOOR OPEN Pull the handle to open the door.

Microwave cooking

- 1 Press the "POWER" button once and "P100" will display and flash.
- 2 Turn the "TIMER/WEIGHT" to select the microwave power. "P100", "P90", "P80", "P70", "P60", "P50", "P40", "P30", "P20", "P10" and "P00" will display in order.
- 3 Press "START/+30 SEC" to confirm.
- 4 Turn the "TIMER/WEIGHT" dial to adjust the cooking time. (The time setting should be between 0:05-95:00).
- 5 Press "START/+30 SEC" to start the cooking process.

Press power button	Cooking power
P100	100%
P90	90%
P80	80%
P70	70%
P60	60%
P50	50%
P40	40%
P30	30%
P20	20%
P10	10%
P00	0%

To stop the cooking process at any time press the "STOP/CLEAR" button.

For further appliance information please refer to microwave user manual.

HOW TO USE YOUR MOTORHOME'S EQUIPMENT

SMOKE ALARM

Operation

Normal Condition

The red LED on the front should flash every 40 seconds to show that the alarm is active.

Lower Power Pack Condition

IMPORTANT: Your smoke alarm requires the power pack to have sufficient capacity of power to operate correctly.

Should your smoke alarm enter a low power pack condition, the unit will emit an audible 'chirp' once every 40 seconds. When this occurs, we recommend you replace the alarm immediately. Your smoke alarm will continue to warn of this low power pack for at least 7 days, however, failure to change the alarm after this time would mean your smoke alarm may have insufficient power to alert you in a real fire situation. When the alarm is removed from the base plate the power pack will automatically deactivate and the low power warning chirp should stop, allowing you to dispose of the alarm.

Low Battery Warning Silence

This feature can temporarily silence the low battery chirp for 8 hours which is particularly useful if the warning begins during the night. This feature may be repeated up to 10 times, but is not a substitute for replacing the smoke alarm.

Alarm Test

The alarm must be properly attached to the base plate before it can be tested.

- Press the test button in the centre and release.

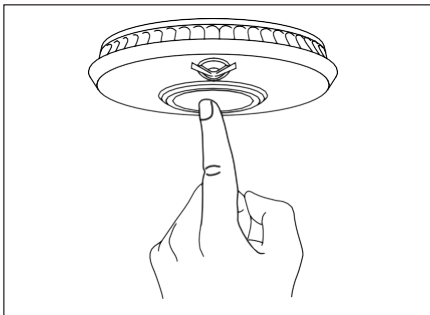

- The unit will give an audible alarm consisting of 2 cycles of 3 loud beeps, then stop automatically.

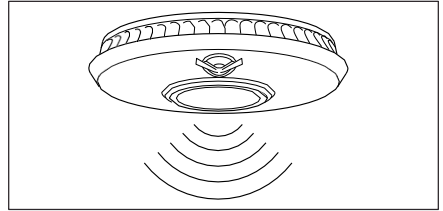

- The red LED on your alarm will flash rapidly during the audible signal.

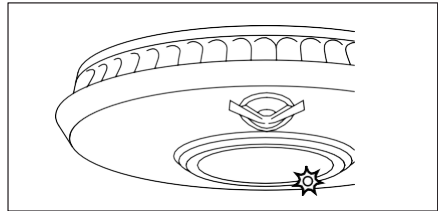

Note: The test button accurately tests the alarm's smoke sensing circuit, there is no need to test your alarm with smoke. If your smoke alarm fails to give an audible test signal, please refer immediately to the trouble shooting guide at the end of this manual.

WARNING: You should test your smoke alarm every week.

HOW TO USE YOUR MOTORHOME'S EQUIPMENT

ALARM SMART SILENCE™

DANGER: If your smoke alarm emits the full alarm signal and you are not testing the unit, the smoke alarm is warning you of a potentially dangerous situation that requires your immediate attention. Only use the alarm silence function after making sure that there is no ongoing fire emergency situation. Do not block the vents on the alarm or disable the smoke alarm in any way, as this will remove your protection. Smoke alarms can sometimes react to cooking fumes or other non emergency situations. Your smoke alarm features "Smart Silence" technology. In the event of a known false alarm your smoke alarm can be temporarily silenced by pressing the central test button. Your alarm will automatically return to full sensitivity within 10 minutes.

Note: If the level of smoke reaching the alarm is very high, the alarm silence will be overridden and the alarm will continue to sound.

- Press and release the silence button, the alarm sound will shortly stop.

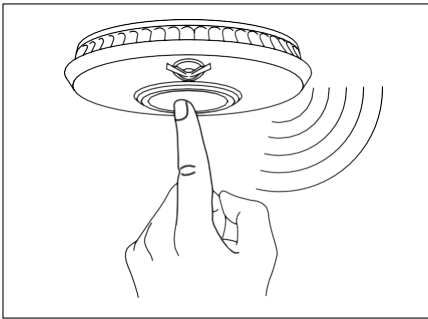

- Your alarm will silence and enter into a reduced sensitivity reset cycle for approximately 10 minutes.

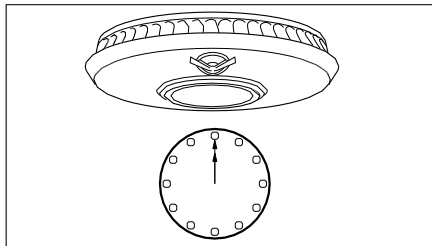

During the reduced sensitivity reset cycle, the red LED on your alarm will continue to flash more rapidly than normal, approximately once every second.

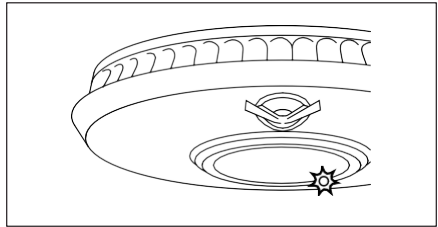

- Your alarm will automatically return to full sensitivity on completion of the reset cycle and the red LED will revert to flashing once every 40 seconds.

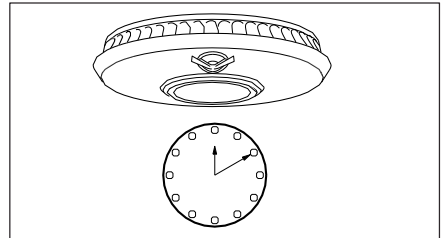

DANGER: Never ignore any alarm. Ignoring the alarm may result in injury or death. If your smoke alarm activates and alarms and you are not absolutely certain of the source of the smoke, get everyone out of the caravan immediately.

LOW BATTERY WARNING SILENCE

Low battery warnings often start at night or when it may be inconvenient to replace your alarm. You can silence the audible chirp for a period of 8 hours by pressing the test button. Your smoke alarm will still detect smoke during this time of low battery warning silence. However, it is recommended that you replace your alarm immediately and certainly within 7 days, as your alarm may then have insufficient power to warn you of a real fire situation after this time.

WARNING: Your smoke alarm cannot be silenced if the chirp is indicating a fault. In this instance, the unit should be replaced immediately to ensure protection in the event of a fire.

HOW TO USE YOUR MOTORHOME'S EQUIPMENT

MAINTENANCE

Your smoke alarm has been designed to be as maintenance-free as possible, however there are several things you must do to keep it working properly.

CAUTION: Your smoke alarm is a sealed electrical device and no attempt should be made to open the case. Attempting to open the case will invalidate your warranty.

Testing

Test your smoke alarm once every week see 'Alarm Test'. Any test failures should be reported to the Technical Support Team.

Cleaning

As a minimum your smoke alarm should be cleaned once every 3 months using your vacuum cleaner fitted with the soft brush attachment.

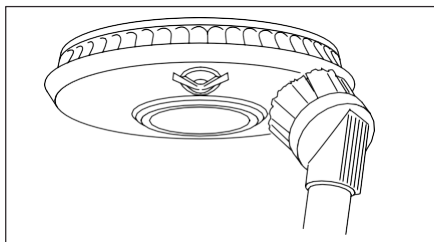

WARNING: Your smoke alarm may false alarm when it is being cleaned using a vacuum cleaner.

IMPORTANT: Do not use solvents or cleaners on your smoke alarm, as they may cause damage to the sensor or circuitry. The unit can be wiped with a slightly damp cloth.

CAUTION: Do not paint the smoke alarm as this may block the openings and prevent smoke from entering the sensor.

CARBON MONOXIDE ALARM

Carbon monoxide and how it can affect you and your family

Carbon monoxide is a dangerous poisonous gas that kills hundreds of people each year and injures many more. It is often referred to as the silent killer because it has no odour or taste and cannot be seen. Like oxygen, CO enters the body through the lungs during the normal breathing process. It competes with oxygen by replacing it in the red blood cells, thereby reducing the flow of oxygen to the heart, brain and other vital organs. In high concentrations, CO can kill in minutes.

Many cases of reported carbon monoxide poisoning indicate that while victims are aware they are not feeling well, they become disorientated and unable to save themselves by either exiting the building or calling for assistance. Exposure during sleep is particularly dangerous because the victim does not wake up.

Symptoms of CO poisoning

The following symptoms may be related to CO poisoning which all household members should be made aware of:

- Mild Exposure: Slight headache, nausea, vomiting, fatigue (often described as 'flu-like' symptoms).
- Medium Exposure: Severe throbbing headache, drowsiness, confusion, fast heart rate.
- Extreme Exposure: Unconsciousness, convulsions, cardiorespiratory failure, death.

Your CO detector monitors the level of CO as parts per million (ppm) in the atmosphere surrounding the detector.

- 35ppm The maximum allowable concentration for continuous exposure for healthy adults in any 8 hour period, as recommended by the Occupational Safety and Health Administration (OSHA).
- 200ppm Slight headache, fatigue, dizziness, nausea after 2-3 hours.
- 400ppm Frontal headaches within 1-2 hours, life threatening after 3 hours.

HOW TO USE YOUR MOTORHOME'S EQUIPMENT

800ppm Dizziness, nausea and convulsions within 45 minutes.
Unconsciousness within 2 hours.
Death within 2-3 hours.

Should you suspect CO may be affecting you or your family, open the doors and windows of your caravan to ventilate, turn off your appliances and evacuate the premises. At this time the authorities should be contacted to locate the source of the carbon monoxide before re-entering the caravan. Medical attention should be sought for anyone suffering the effects of CO poisoning.

Common sources of CO

- Oil and gas boilers
- Portable generators
- Oil or solid fuel cookers
- Barbecues
- Clogged chimneys
- Wood or gas fireplaces
- Cigarette smoke
- Gas appliances
- Any fossil fuel-burning appliance

WARNING: This carbon monoxide detector is not a combustible gas detector, nor a smoke detector. Please install the proper detectors to detect combustible gases, or smoke.

This CO detector should not be seen as a substitute for the proper installation, use and maintenance of fuel-burning appliances (including appropriate ventilation and exhaust systems), nor the sweeping of chimneys.

WARNING: Variables relating to your fuel-burning appliances can change at any point eg. the flue or chimney could suddenly become blocked or damaged, appliances may stop running correctly or circumstances in neighbouring properties may change resulting in the presence of carbon monoxide. For this and other reasons do not use this carbon monoxide detector on an intermittent basis, or as a portable detector or an intermittent basis, or as a portable detector for trying to trace one source of the spillage of combustion products from fuel-burning appliances or from chimneys.

Do not:

- IGNORE ANY WARNING FROM YOUR CO DETECTOR!
- Burn charcoal inside your home, caravan, tent or cabin.
- Install, convert or service fuel-burning appliances without proper knowledge, skill and expertise.
- Use a gas cooker for heating a room.
- Operate unvented gas burning appliances using paraffin or natural gas in closed rooms.
- Operate petrol-powered engines indoors or in confined areas.
- Barbecue indoors, or in an attached garage.
- Ignore a safety device when it shuts an appliance off.

Always:

- Buy appliances accepted by a recognised testing laboratory.
- Install appliances according to the manufacturer's instructions.
- Have appliance installations carried out by professionals (for gas appliances engineers should be registered on the Gas Safe register).
- Have your appliances checked regularly by a qualified service engineer.
- Have your chimneys and flues cleaned professionally every year.
- Make regular visual inspections of all fuel-burning appliances.
- Open windows when a fireplace or oil/solid fuel cooker is in use.
- Only install CO detectors that meet the requirements of EN 50291-1:2018 and EN 50291-2:2019 in your home.
- Be aware of CO poisoning symptoms.
- Educate yourself and your family on the sources and symptoms of CO poisoning and how to use your carbon monoxide detector.

HOW TO USE YOUR MOTORHOME'S EQUIPMENT

ALARM ACTIVATION

To activate your CO alarm, pull the disabling tab out of the device.

Wait up to 1 minute for the green LED to flash to confirm the device is active.

Press the Test/🔊× button to test the alarm. The alarm will sound. (The alarm will not sound before the 1 minute activation period is complete).

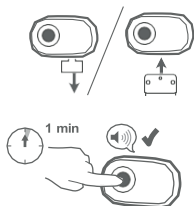

ALARM SILENCE

WARNING: If the cause of an alarm is unknown, ventilate and evacuate your property before using this feature.

Press the Test/🔊× button.

The sounder will stop and enter into Silence mode for 5 minutes.

Note: The alarm will not silence if more than 150ppm has been detected.

Silence mode can only be activated once (until CO returns to negligible levels).

Once the Silence mode is enabled, if the CO level rises above 150ppm the device will exit Silence mode and continue to sound.

After 5 minutes if the CO level is still high, the device will continue to sound.

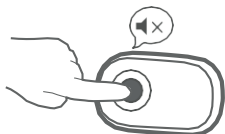

Understanding the products indicators

The higher the concentration of carbon monoxide detected by the detector, the quicker it will respond. When sufficient carbon monoxide is detected a loud audible signal (85 dB at 3m) will be emitted and the Alarm LED will flash red once every second.

The alarm will sound:

- Between 60 and 90 minutes when exposed to 50ppm of CO.
- Between 10 and 40 minutes when exposed to 100ppm of CO.
- Within 3 minutes when exposed to 300ppm or more of CO.

ALARM IN ABSENCE

When a CO alarm has occurred in your absence, your device will notify you so that you can take appropriate action at the earliest opportunity.

If the device is not silenced during an alarm, it will continue to sound until the CO level has reduced to below 50ppm.

After which, the device will flash the red warning light twice every 20 seconds to indicate that dangerous CO levels have been detected in your absence.

The red warning light will continue to flash for 7 days if the Test/🔊× button is not used to cancel it.

Red flash: 🌞 --> 🌞

MAINTENANCE

Test the alarm every month. Press the Test button. The alarm will sound.

If the alarm does not sound. Contact Technical Support.

Note: The above method fully tests all elements of the alarm. Additional, but not essential testing may be conducted using the Sense-CO Test mode and CO gas.

To ensure your alarm is tested correctly using low concentrations of test CO gas, please follow these instructions.

1. To activate Sense CO testing, triple press your alarm test button. **Please note:** The request to enter Sense CO mode will timeout after two minutes if no further action is taken.
2. Once Sense CO is activated, the CO acquisition task is performed constantly. The yellow 'ventilate' LED light will flash once per second and the unit will provide indications if the CO level is >30ppm during the following two minutes.

HOW TO USE YOUR MOTORHOME'S EQUIPMENT

3. If levels of CO are detected, the alarm will sound four loud beeps, with a five second gap between each beep, before another four loud beeps.

As motorhomes have an increased risk of carbon monoxide ingress through air vents due to the nearby presence of other vehicles, engines, generators or barbecues, this method of testing is highly recommended for the industry.

Please do not use any other test method than what is detailed in the product manual.

Do not tamper with the alarm as this could cause electric shock or malfunction.

CAUTION: Sensor testing should only be performed by a responsible adult. This test should only be performed annually.

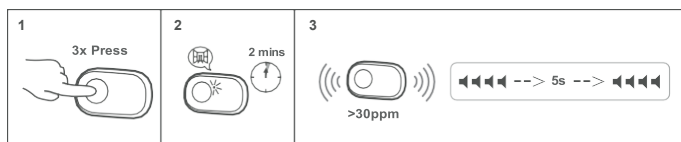

Vaccum your alarm every 3 months. Do not use cleaners or solvents.

Do not paint the alarm.

Replace the alarm every 10 years.

The replacement date can be found next the 'REPLACE BY' marking on the alarm.

SYSTEM STATUS INDICATORS

Your CO alarm constantly checks the accuracy of its sensor and circuitry. All alarms must indicate when there is a fault or if the battery power is low (identified by the ! icon).

If any of the settings are found to be incorrect or if the batteries become low, the device will sound an audible chirp and display an amber flash pattern for up to 30 days.

IMPORTANT: This does not mean that the alarm has detected carbon monoxide. If there is a fault, your CO alarm will display the following fault indication patterns.

	Audible pattern	Amber LED/LCD	Action required
Low battery	1 beep/min	1 amber flash/min	Replace the batteries
Fault	2 rapid beeps/min	2 rapid amber flashes/min	May not detect CO - replace immediately
End of life	3 rapid beeps/min	3 rapid amber flashes/min	May not detect CO - replace immediately

If your alarm is within warranty, contact Technical Support.

Your CO alarm must be replaced immediately if there is a fault or the device indicates End of Life. An alarm with a fault or signalling End of Life may not detect a CO leak.

SLEEP EASY™ SILENCE FEATURE

If a low battery warning 'chirp' occurs at night, it may be inconvenient to replace the batteries or alarm. You can silence the 'chirp' by pressing the Test/⊗ button. The alarm will silence for 8 hours and the amber LED will continue to flash.

Note: You can silence your device a maximum of 10 times.

If your alarm is an FA3313 and is signalling low batteries, replace the batteries as soon as possible.

Once the batteries have been replaced, the Sleep Easy feature will be disabled for 30 days.

Note: During Sleep Easy mode the unit still detects CO and will alert you to any new faults.



ROOFLIGHTS

Your motorhome is fitted with at least one type of the following roof lights:

The Heki 2 (Where Fitted)

To Open To The Tilted Position:

- (i) Press the knob in the toggle catches on either side of the rooflight and turn through approx. 90°.
- (ii) Grasp the metal bar in the middle, snap it out of its holder, swivel down and press the rooflight upwards. (The rooflight is held by the two gas springs after approx. 150mm).
- (iii) Swivel the metal bar towards the rooflight and snap into its holder.
- (iv) To close the rooflight, proceed with steps (i to iii) in reverse order.

To Open In The Intermediate Position:

- (i) Open the toggle catches on either side of the rooflight.
- (ii) Grasp the metal bar in the middle; snap it out of its holder, swivel down and press the rooflight outwards. Rooflight is opened automatically after approx. 150mm by the two gas springs).
- (iii) Open both fasteners and swivel the metal strap towards the intermediate position and pull the rooflight down until the metal strap is stopped by the fasteners.
- (iv) To close, proceed with steps (i to iii) in reverse order.

To Open In The Ventilation Position:

- (i) Open the toggle catches on either side of the rooflight.
- (ii) Using both hands on the two toggle catches, press the rooflight up about 2cm and fasten the toggle catches in the corresponding setting.
- (iii) To close, proceed with steps (i-ii) in reverse order.

Closing The Blinds:

- (i) Take hold of the end rod (without rocker) in the recessed grip and engage in the opposite end rod (with rocker).
- (ii) Select the required position (blind/flyscreen) by moving both joined end rods together.

CAUTION: In extremely bright sunshine, the blind must only be closed two-thirds, and the rooflight must be set in the continuous airing position.

Opening The Blinds:

- (i) Move blind (end rod with rocker) right to the outside.
- (ii) Hold the recessed grip with one hand; with the other hand, press the rocker and move the blind back (do not let it recoil).

CAUTIONS:

- Do not stand on the acrylic rooflight.
- Close HEKI 2 completely before moving off.
- Do not leave your Motorhome when HEKI 2 is open.
- Please consult your supplying dealer if you have any problems or defects.
- Remove any snow/ice or dirt before opening the roof.
- Do not open when it rains or when there is a strong wind.

MPK Rooflight (Where Fitted)

Operation

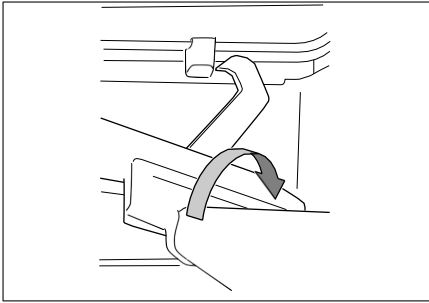

To open the rooflight, both pleated blinds must be open.

Grip the crossbar in the middle and turn it towards the opening side. Now the rooflight can be opened by pushing the crossbar. As soon as you release the crossbar, the opening mechanism snaps into this position.

To close the rooflight, turn it again and push it back in the opposite direction. When the end position is reached, the rooflight is locked automatically.

- Keep the pleated blinds open when driving to avoid driving noise and damage from the airstream.
- To avoid heat accumulation do not close blind completely during the day. Open both pleats when not using the vehicle.

Cleaning

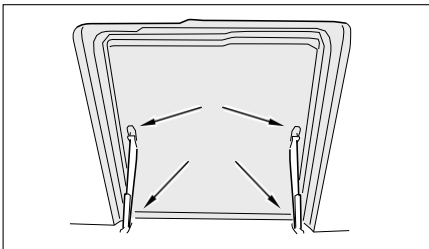

For easier cleaning, the dome can be removed from the inner frame by releasing the four plastic split pins.

Do not loosen any screws that are used to fasten the dome or the opening mechanism.

Use only clear water and a soft sponge.

Solvents may attack the plastic and make it brittle.

After cleaning, maintain the sliding surfaces with a thin layer of Vaseline or WD40. This makes the extension mechanism glide more easily. The rubber seals can be maintained with talcum powder.

Pay attention that the pins positively click into the locked position when re-installing the dome. The lever arm pins should be re-installed with the flat side towards the dome.

Clean the pleated blinds with a soft brush, dry cloth or feather duster.

We strongly advise against wet cleaning, as this can damage the insect screen and blackout pleated blind.

Midi Heki Rooflight (Where Fitted)

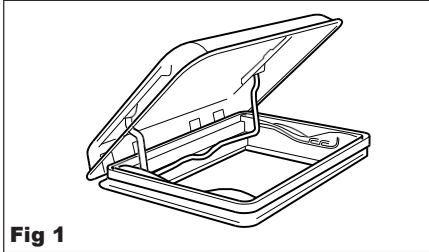

Fig 1

- (i) To open, push the large central button (Fig 2).

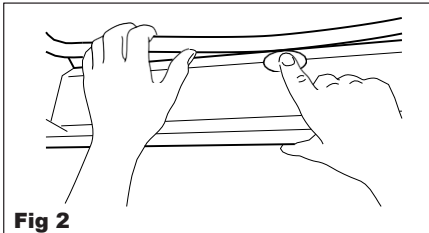

Fig 2

- (ii) Whilst depressed, slide the bar to the desired position and locate into the stops provided (Fig 3).

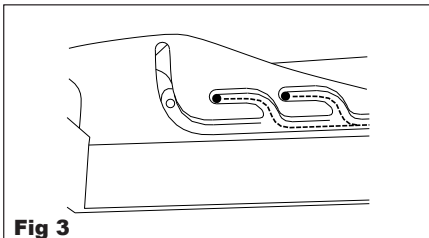
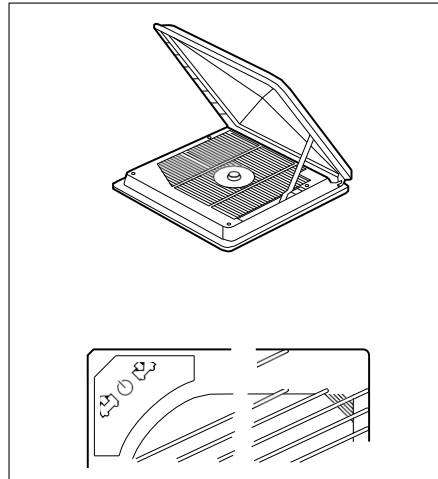

Fig 3

The Omnivent (12v) Rooflight (Where Fitted)



The Omnivent is a double-glazed roof light constructed from a synthetic ultra-violet screened material. Its side-operating mechanism allows a completely free central opening with built-in fixed ventilation when closed. It operates as an extractor fan and air intake fan.

Please note: Do not change the direction of the fan unless it has been switched off 'O' position and the blades have stopped rotating.

DOOR FLYSCREEN

The exterior door flyscreen can be opened or closed from both inside and outside of the Motorhome and does not restrict door openings.

When opening or closing the door flyscreen use the finger grip provided.

HOW TO USE YOUR MOTORHOME'S EQUIPMENT

WINDOWS

Your new Motorhome will be fitted with Polyplastic opening windows.

Polyplastic Window Opening

- (i) In order to open the Polyplastic window it is only necessary to move the catch upwards and release the catch from the backing plate.
- (ii) The Polyplastic window should remain in the open position once opened, however if it does not then tighten the friction control on the window stays to increase the holding force.
- (iii) The Polyplastic window is also fitted with a night ventilation position where the catch is set to the centre position on the backing plate; in this position it may be possible for rain to enter the motorhome in adverse conditions.

SHOWER

Using your Motorhome Shower

To safely enjoy showering in your new motorhome, the following guidelines should be used.

- Advise others that you are planning to have a shower and that they should not use other taps whilst you are showering.
- Ensure there is a sufficient supply of cold water available.
- Divert the shower head or move to the side, turn on the shower, carefully test the temperature with your hand and regulate the temperature as necessary before standing underneath the shower.
- Supervise closely the young, elderly and those with reduced mentally or sensory impairment.

CAUTION: Water may be very hot.

TAPS

Kitchen Taps

Your new motorhome will be fitted with a mixer tap.

CAUTION: The water temperature could be very high so do not lift the lever with the tap turned to the full left position. For winter storage and to prevent frost damage the tap swivel must be left in the centre up position.

Washroom Taps And Showers

Your motorhome will be supplied with either a vanity mixer tap or separate shower mixer, or with a combined mixer tap with retractable shower head.

Note:

- The water temperature could be very high so do not lift the lever with the tap turned to the full left position.
- For winter storage and to prevent frost damage the tap swivel must be left in the centre up position.

HOW TO USE YOUR MOTORHOME'S EQUIPMENT

INTERNAL DOORS

Toilet/Shower Room Doors

Operation from within the shower room

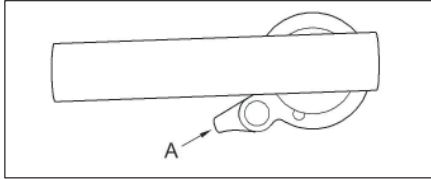

To lock the door, push the small lever down (identified in the drawing as A) then to unlock, push this lever back to the original position.

Operation from outside the shower room

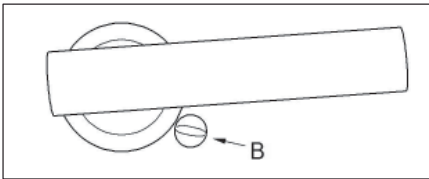

To open and close the door, push the lever down.

If the door is locked and needs to be opened, it can be opened by inserting a coin into the lower slot (identified in the drawing B) and turning the slot.

Other Internal Doors

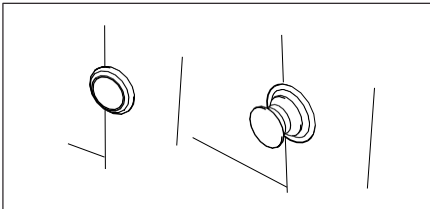

Other internal doors such as the wardrobe and table storage locker are fitted with a 2-position button lock. Push the button to lock the door and the button should remain flush with the door. Push the button again to release and the button should then protrude from the door surface.

Paddle Latch

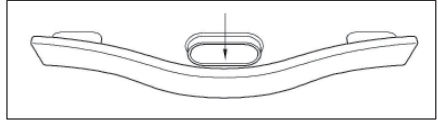

To open the locker, push the paddle downwards and pull the handle towards you.

Concealed Latch

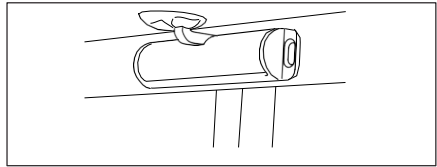

To open the locker, press the latch and pull the door towards you.

HOW TO USE YOUR MOTORHOME'S EQUIPMENT

Magnetic Catches (Where Fitted)

Magnetic catches work on contact with the metal plate on the rear of the door. Simply close the door until the magnet engages and holds the metal plate.

Pulling the door towards you with a moderate force will be sufficient to disengage the magnetic catch and open the door.

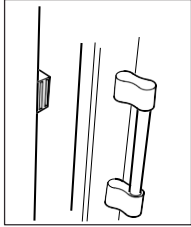

HOW TO USE YOUR MOTORHOME'S EQUIPMENT

THETFORD C-260 CASSETTE TOILET RANGE

Introduction

The Thetford Cassette Toilet is a high quality product. The toilet forms an integral part of your motorhome bathroom, thanks to its functional design which combines modern styling and ease of use. The C-260 Cassette Toilet is manufactured from high quality synthetic materials which makes it a durable, user and maintenance friendly toilet.

The toilet is made up of two parts: a permanently fixed part and a Waste Holding Tank that is accessible from the outside. The removable Waste Holding Tank is located under the toilet bowl and can be removed via a door on the outside of the motorhome. The Thetford Cassette Toilet is the solution to the sanitary problem in your motorhome!

The operating instructions cover Thetford Cassette Toilet models C-260S, C-260CS (models connected to the vehicle's central water tank) and C-260CWE (model with its own flush-water tank). There are differences in the use of these models. Please ensure that you follow the instructions that apply to your toilet model.

Preparing for use (standard)

1. Open the access door on the outside of your motorhome.
2. Remove the Waste Holding Tank by pulling the safety catch (which holds the tank in place) upwards.
3. Pull the Waste Holding Tank outward to the stop. Tip it slightly and take the tank fully out.
4. Place the tank upright and turn the rotating emptying spout upwards. The emptying spout ensures that the tank can be easily and hygienically emptied.
5. Remove the cap, with the measuring cup inside, from the emptying spout and pour the correct dosage of Thetford toilet fluid (see product label) into the holding tank. This avoids unpleasant smells and keeps the inside of the tank clean. Next add approximately 2 litres of water - enough to ensure that the bottom of the Waste Holding Tank is covered. Far more

information on Thetford toilet fluids, see last page of this manual. Screw the cap back onto the emptying spout and turn back to its original position.

Note: The Emptying Spout Measuring Cap is supplied in the same packaging as this manual.

WARNING: Never add toilet fluid directly via the blade or the toilet bowl as this could damage the lip seal of the Waste Holding Tank. Always pour the fluids via the emptying spout.

6. Slide the Waste Holding Tank back into its original position via the access door. Make sure that it is secured with the safety catch. Close the access door and lock it. Your Thetford toilet is now ready to use.

WARNING: Never use force if you cannot get the tank back into place easily. This may cause serious damage. If blockage occurs, always check if the blade handle is in the correct (closed) position.

7. For toilets with own Flush-Water Tank: Open the water filling door and fill the flush-water tank with the correct dosage of Aqua Rinse. This Thetford toilet fluid keeps the flush water fresh and improves the flushing. Next, fill up the flush-water tank with clean water (approximately 8 litres) using a ferry can or hose. Your toilet is now ready to use.

Preparing for use with Optional Features

8. Automatic Ventilator: Open the access door on the outside of your motorhome and remove the Waste Holding Tank (as described above).
9. Remove the filter housing cover and if no filter is present, place a new filter into the filter housing. Peel off the sticker lids on the filter. Place back the cover of the filter housing.

Using the toilet (standard)

10. Turn the bowl to the desired position with the lid closed and using both hands.
11. To activate the control panel, press the flush-button once. The control panel display will stay activated for

HOW TO USE YOUR MOTORHOME'S EQUIPMENT

Standard	Optional features
<p>Note: Optional features can be bought from Thetford dealerships.</p>	

Control panel (with optional features)	PARTS
	<ul style="list-style-type: none"> a) Removable Seat and Lid b) Swivelling Toilet Bowl c) Blade Handle d) Flush Button e) Waste Holding Tank Level Indicator f) Water Filling Door (only if toilet has own flush-water tank) g) Rotating Emptying Spout h) Automatic Pressure Release Vent i) Sliding Cover j) Removable Mechanism k) Vent Plunger l) Pull-out Handle m) Wheels n) Blade Opener o) Access Door to Waste Holding Tank <p>Optional Features</p> <ul style="list-style-type: none"> p) Electric Blade q) Automatic Ventilator r) Waste Pump-Out System s) Waste Holding Tank Multi-Level Indicator t) Flush-Water Tank Level Indicator (only if toilet has its own flush-water tank)

HOW TO USE YOUR MOTORHOME'S EQUIPMENT

approximately 5 minutes. Run some water into the bowl by pressing the flush button again briefly.

- The toilet may be used with the blade open or closed. To open the blade, slide the blade handle under the toilet bowl sideways. After use, open the blade (if still closed) and flush the toilet by pressing the flush button for several seconds (if necessary re-activate the control panel). Close the blade after use.

WARNING: If your toilet has its own flush-water tank, please make sure that you do not travel with a flush-water tank that is too full. Do not travel with water in the toilet bowl. Failure to adhere to this notice may result in water damage to your motorhome.

Using the toilet with Optional Features

- Electric Blade:** Push the electric blade button on the control display to electrically open or close the blade. In the case of failure, you can manually open or close the blade by sliding the small handle under the toilet bowl sideways.
- Automatic Ventilator:** The ventilator automatically starts when the control panel is activated (by pressing the flush button) and will automatically shut off after approximately 5 minutes. The Automatic Ventilator Indicator will flash until automatic shut-off occurs. If you want to stop the ventilator, press the Automatic Ventilator button. If you want to re-start the ventilator, press the button again (the LED will start flashing again).
- Flush Water Tank Level Indicator** (only for toilets with own flush-water tank): When the Flush Water Tank Level Indicator lights up, refill the flush-water tank, as only about 1.5 litres of water is left in the tank, which is sufficient for approximately 2 flushes.

Emptying

The Waste Holding Tank has a capacity of 18 litres and requires emptying when the red light (LED) on the toilet control display lights up, when the Waste Holding Tank only has

capacity for approximately 2 more litres, which is no more than two to three further uses.

Make sure that the blade is closed. Open the access door located outside the vehicle, pull the safety catch upwards and remove the Waste Holding Tank.

- Place the Waste Holding Tank in an upright position (Pull-Out Handle at the top, Wheels at the bottom). Slide the handle sideways - to the front of the tank - until it snaps out of its locked position.
- Pull the handle up and wheel the Waste Holding Tank to an authorised waste disposal point.
- Push the handle back into its locked position. Turn the emptying spout upwards and remove the cap from the spout. Hold the Waste Holding Tank in such a way that during emptying you can operate the vent plunger with your thumb. To empty the tank without splashing, depress the vent plunger while emptying the tank. After emptying, rinse the tank and blade thoroughly with water.

WARNING: Do not seriously shake the tank or use high pressure water cleaners. This may cause damage to the tank's interior.

Note: The vent plunger should only be depressed once the emptying spout is pointing downwards. Prepare the toilet for re-use if required. Slide the Waste Holding Tank into the toilet and close the access door.

Emptying with Optional Features

- Waste Holding Tank Multi-Level Indicator:** The lower lamp indicates that the Waste Holding Tank is almost empty; the middle lamp indicates that it is more than half full; when the upper lamp lights up, the tank needs emptying as it can only take 2 - 3 further uses.

Note: The Waste Holding Tank Level Indicator will flash when the holding tank is not present. In this case the toilet will not flush.

20. **Waste Pump-Out System:** When activating the control panel this feature automatically lights up. When the Waste Holding Tank Level Indicator illuminates, press the Waste Pump-Out button to pump out the waste from the holding tank into the vehicle's waste tank. The button will flash while the waste is being pumped and will stop automatically (after approximately 5 minutes) when all waste has been transferred. If the vehicle's waste tank is full, the Waste Pump-Out light will flash rapidly and no pump-out will be possible until the central tank is emptied. (Check the level of the vehicle's waste tank on the vehicle's central console). After the Waste Holding Tank has been emptied, there will be approximately 1.5 litres of waste left in the tank. This is normal. Add 2 litres of water and a correct dosage of Thetford toilet fluids to the Waste Holding Tank.

CAUTION: It is vital that the correct amount of toilet fluid is added to ensure the proper breakdown of the waste in the holding tank. Only use the system when the tank is full. Using the system too often on an empty tank can cause damage to the pump, which could cause the system to fail.

Cleaning and Maintenance

The toilet should be cleaned and maintained regularly, depending on the amount of use. To clean Thetford toilets, we advise using water and Thetford Bathroom Cleaner.

Note: Never use bleach, vinegar or other powerful household cleaners that contain these substances. These may cause permanent damage to the seals and other toilet components.

Toilet Bowl

- Squirt Thetford Bathroom Cleaner into the toilet bowl.
- Flush the toilet bowl with water and wipe down the rest of the toilet with a damp cloth.
- Clean seat and lid The seat and lid can easily be removed: Lift the seat and lid assembly and pull the round pins (inside the assembly) outwards from the pin

holes. After cleaning, replace the seat and lid by positioning the round pins in front of the pin holes and push the lid and seat downwards.

- To keep your flush water fresh and to prevent deposits from forming in your toilet bowl, add a correct dosage of Aqua Rinse in your flush water tank, if present, on your toilet.

Tip! For a really shining toilet, dry with a soft dry cloth after cleaning.

Waste Holding Tank

To keep your Waste Holding Tank fresh and clean, Thetford has developed a number of different toilet fluids. Thetford toilet fluids suppress smells, reduce formation of gas, promote breakdown of toilet waste and increase the life span of a mobile toilet. We advise a thorough cleaning of the Waste Holding Tank once each season. Next to using Thetford's Cassette Tank Cleaner, the powerful cleaning agent for the periodical cleaning of the Waste Holding Tank of your toilet, we suggest the following: -

- Remove the removable mechanism from the Waste Holding Tank by turning it anti-clockwise and rinse it under a tap.
- Remove the cover plate from the Automatic Pressure Release Vent by prising it up using a small screwdriver. Use one hand to push the Automatic Pressure Release Vent open while holding the float of the Automatic Pressure Release Vent on the inside of the tank with the other hand. Push the float upwards, turn it 180 degrees and remove it from below. Remove the rubber seal underneath the float. Rinse the float and rubber seal under a tap. Replace the rubber seal and float for the Automatic Pressure Release Vent using the same method in reverse.

The rubber seals in the toilet (the lip seal, the mechanism seal, the automatic pressure release vent seal and the cap seal) should be regularly cleaned with water and treated with Thetford High Grade Seal Lubricant. This will ensure that the seals remain flexible and in good condition. If the toilet is not to be used

HOW TO USE YOUR MOTORHOME'S EQUIPMENT

for any length of time, it is important to treat the seals with Thetford High Grade Seal Lubricant after cleaning.

Note: Never use Vaseline or any vegetable oil except olive oil. These may cause leakage or malfunction. The lip seal is a part of the toilet that is subject to wear. Depending upon the extent and manner of use, the seals will become less effective and will need replacing periodically.

Cleaning and Maintenance for Optional Features

- **Automatic Ventilation:** The filter of the Automatic Ventilation needs to be renewed periodically. After approximately 4 full weeks of use, the filter loses its absorption power.
- **Pump-Out Waste System:** To ensure optimal functionality of the Pump-Out Waste System, periodical maintenance of the tube and pump is recommended. After emptying the Waste Holding Tank completely, fill it with clean water and empty it again. This will clean the pump and the hose. Do this once every 3 weeks when on holiday. This should ensure proper operation of the system.

Winter operation

You can use your Thetford Cassette Toilet as normal in cold weather as long as the toilet is situated in a heated location. If there is a risk of freezing we advise that the toilet is drained by following the instructions under 'Storage'. For environmental reasons the use of antifreeze, such as that used in car radiators, is not recommended.

Storage

It is important that you follow the instructions below if you do not expect to use your Thetford toilet for a long (winter) period.

- Activate the Control Panel by pressing the flush button. Open the blade and press the flush button until water stops flowing into the bowl. Close the blade. Open the access door on the outside of your motorhome and empty the Waste Holding Tank at an authorised waste dump. Follow the instructions for cleaning

and maintenance. To allow the Waste Holding Tank to dry, do not place the cap back on the emptying spout of the tank.

21. If the toilet has its own flush-water tank, place a sufficiently large bowl under the drain tube to catch the remaining water from the flush-water tank and remove the drain plug. When no more water exits, put the drain plug on the drain tube, put it back in its original position and close the access door. If the toilet is connected to the vehicle's water tank, please follow your vehicle's instructions for draining the central water system. If your toilet is optionally featured with a Waste Pump-Out System, take out the Waste Holding Tank and completely clean it (see Cleaning and Maintenance). After cleaning, fill it with water, put it back and empty it via the waste pump-out system. Repeat this twice.

Toilet unit malfunctions

Contact your dealer or a Thetford Service Centre.

We advise draining the fresh water tank prior to travelling. Antifreeze should not be required if the motorhome is heated. If you do wish to use antifreeze, brands containing the following properties may be used in the fresh water tank:

- Ethylene glycol
- Mono-Ethylene glycol
- Propane-diol
- Glycerol
- Ethane-diol
- Glycol

Never use alcohol based antifreeze, i.e. Methanol, Ethanol, and Iso-propanol.

HOW TO USE YOUR MOTORHOME'S EQUIPMENT

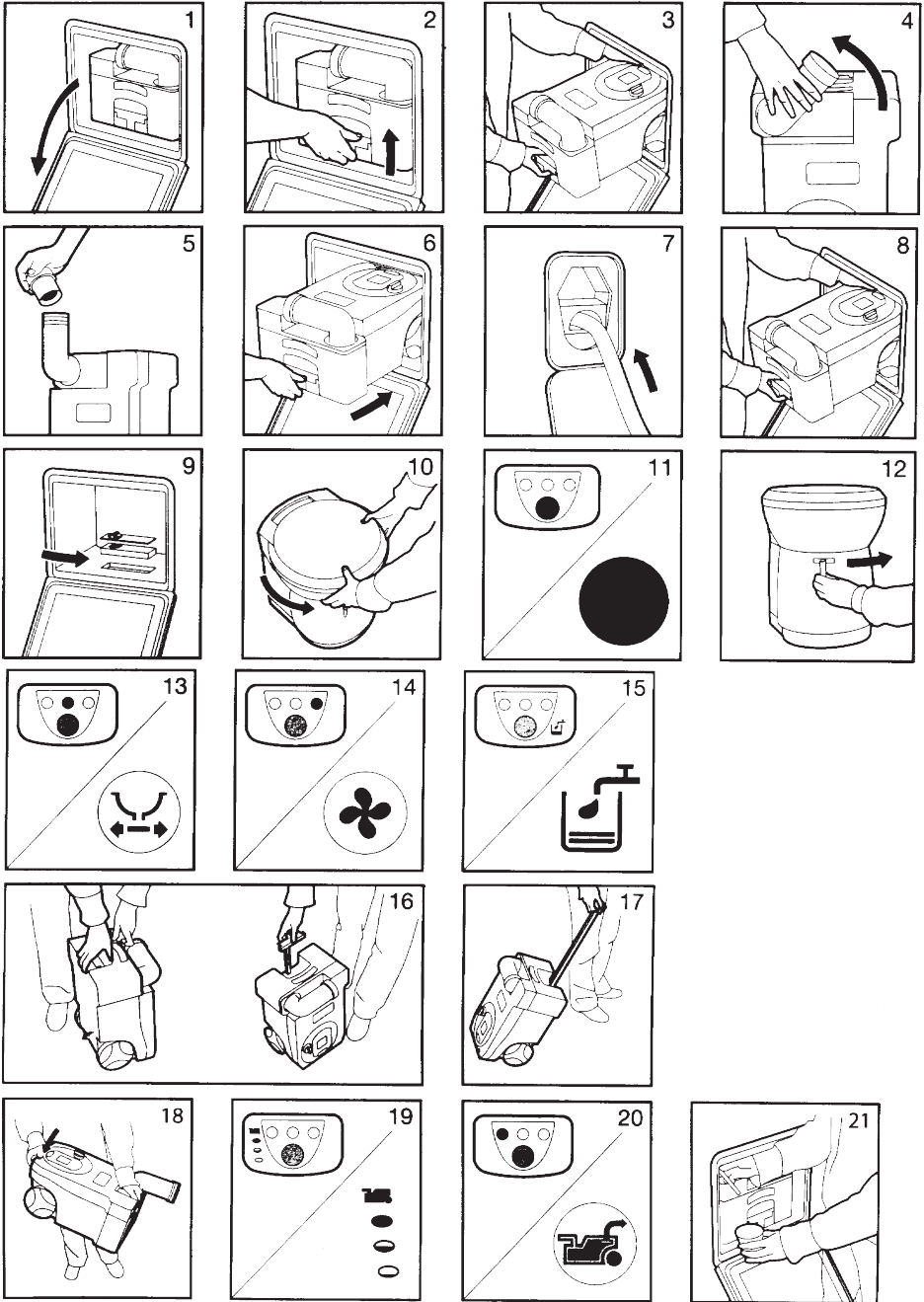

HOW TO USE YOUR MOTORHOME'S EQUIPMENT

TELECO TV AERIAL

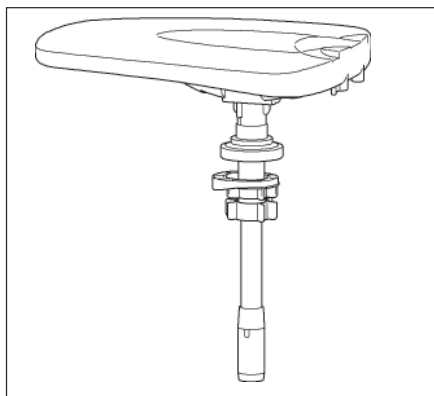

Instructions for the reception of horizontal or vertical polarity

signals In some areas certain TV signals are transmitted with horizontal polarity while others are transmitted with vertical polarity.

This antenna can be positioned both horizontally and vertically by simply turning the knob at the bottom of the mast.

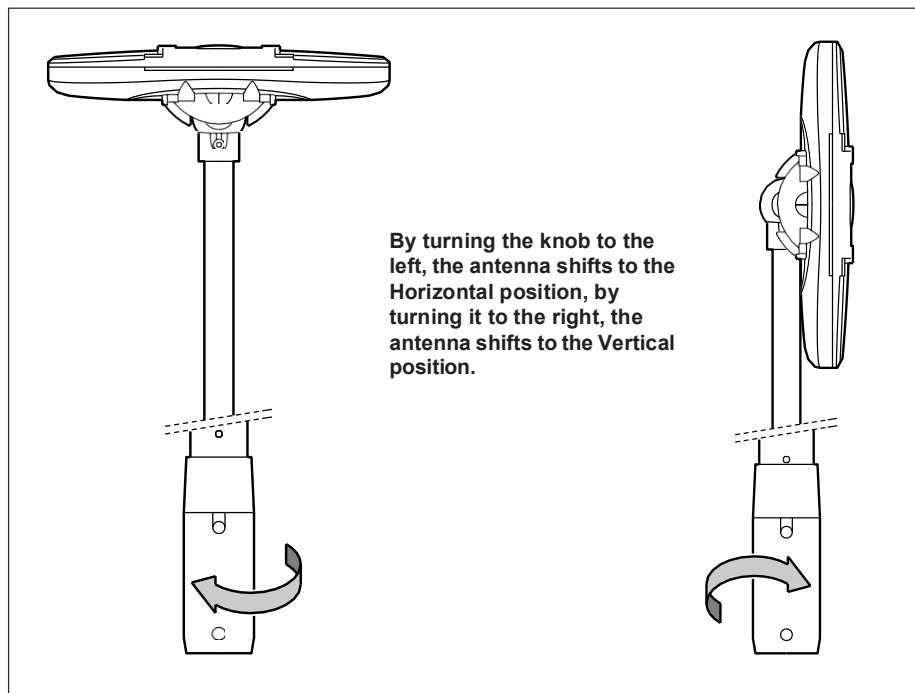

HOW TO USE YOUR MOTORHOME'S EQUIPMENT

Connection to the amplifier

Connect the lead exiting from the pole to the ANT input of the amplifier. Connect with the relevant lead, the TV connector of the amplifier with the television. Connect the amplifier to 12 Vdc source, making sure you do not invert the + and - terminals.

Operating Instructions

- 1) Rotate slowly the dB dial of the amplifier clockwise to the maximum +
- 2) Tune the television to a channel available in the area where you are located.
- 3) Rotate and lift the antenna via the suitable pole until you get the best image on the TV.

Useful Tips

Not all the television signals you can receive in the zone where you are located will necessarily originate from the same direction. So if the quality of a programme image is poor try rotating the antenna as the signal may be coming from a direction different from the others.

Gain Adjustment

With the dB dial turned all the way clockwise, amplifier sensitivity will be at maximum and it is therefore able to receive the weakest signals. If, instead, the signals are too strong the images on the TV screen can have some stop or macroblocks. In this case rotate the dB dial anti-clockwise slowly until the image is perfect.

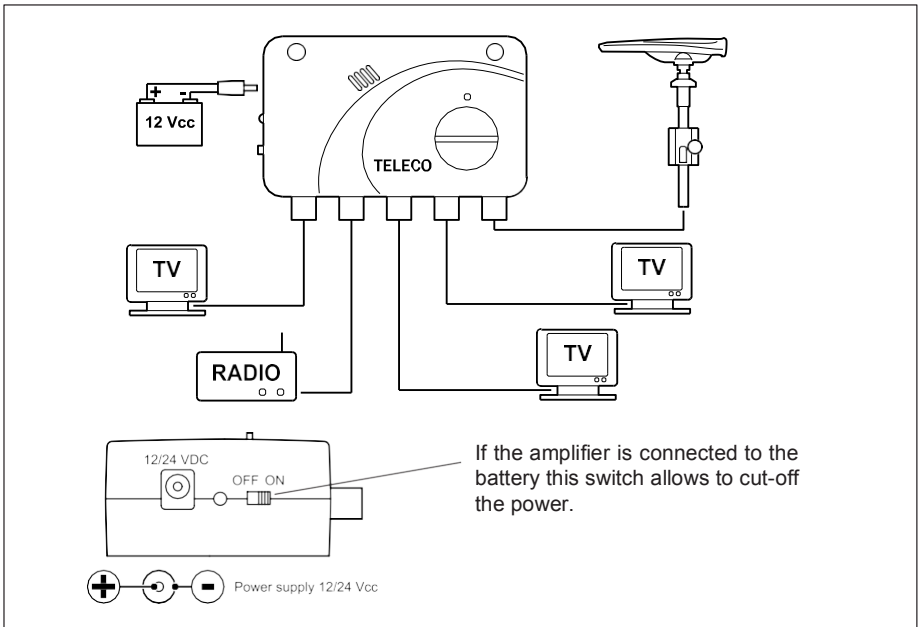

HOW TO USE YOUR MOTORHOME'S EQUIPMENT

HOW TO USE YOUR TV AERIAL

Digital TV set-up guide

Connect aerial and power

Fix the TV to a bracket or place on a stable, flat surface then connect the aerial cable and power lead to the TV and sockets.

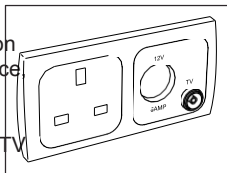

Check the power is on

The aerial needs power to work correctly; check that the power is switched on (Switch on either the mains and/or battery power to the vehicle) both power sources switch on the aerial (12 Volts).

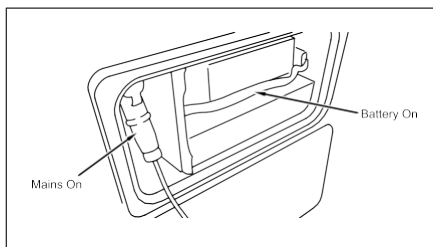

Tune in TV and choose transmitter

Switch on the TV and tune in the channels. If the vehicle is moved or a different socket is

used you might need to re-tune TV. If the first

transmitter picked up has poor quality pictures, then re-tune and pick another transmitter.

With Digital TV's there will be a re-tune button on the remote control use this feature and then choose manual re-tune.

Most digital TV's will also allow you to choose the transmitter which is normally available via the Menu function.

This will vary by TV manufacturer so if you have any problems undertaking this task please refer to your TV manual.

TROUBLESHOOTING GUIDE

Check aerial/radio fuse

If there is no power, check the 5 amp fuse located within the PDU marked radio is in working order.

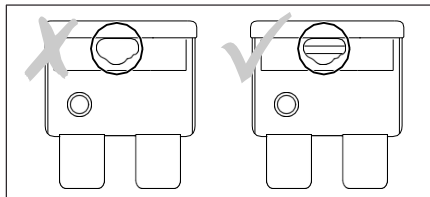

Check TV monitor

Check the TV is working correctly by ensuring that the channels tune in correctly in your home. If the TV does not pick up the expected number of channels we would recommend you get the TV checked out.

Number of channels picked up from your house connections

DTV : 0 Programme(s)

Radio: 0 Programme(s)

Data : 0 Programme(s) **X**

DTV : 72 Programme(s)

Radio: 24 Programme(s)

Data : 21 Programme(s) **✓**

Check the coax lead is of good quality

Check that the TV aerial lead is of good quality (Normally cheap leads from the supermarket give reception problems, they are normally mass produced and made to a wider tolerance).

Ensure the coax lead from the aerial socket to the TV is suitable for digital reception (if in doubt, ask for advice).

Check location for signal strength

Check that the digital tv signal strength where the vehicle is situated is Very Good to Good.

Go to: www.digitaluk.co.uk

Enter the postcode and check signal strength.

HOW TO USE YOUR MOTORHOME'S EQUIPMENT

Note: Sometimes transmitters are being repaired or upgraded

Go to: http://www.digitaluk.co.uk/help_and_advice/engineering_works

Check if signal is OK that day / week.

Check there are no obstructions

Is the vehicle outside in an open space?

Check that the vehicle has no obstructions:

House lean to/canopy

Trees (also blowing in the wind) House or other buildings

Hills

Large vehicles

In a valley etc.



Understand digital signals

Digital signals have what the industry calls the Cliff effect.

The Cliff effect is either you have a picture or not within a very small difference of signal strength. This happens with both weak and strong signals.

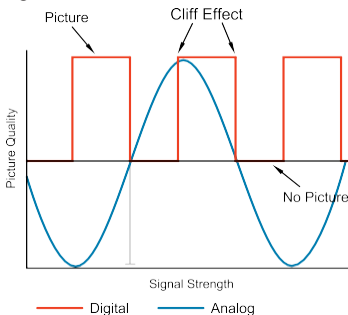

TROUBLESHOOTING GUIDE - CHECKLIST

ACTION	✓OR X
Check aerial fuse	
Connect aerial and power	
Check the power is on	
Tune in TV and choose transmitter	
Check TV monitor	
Check the coax lead is of good quality	
Check location for signal strength	
Check for obstructions	
Understand digital signals	

If after following this guide you still have problems, contact your local Retailer or Approved Workshop.

HOW TO USE YOUR MOTORHOME'S EQUIPMENT

HOW TO MAKE UP YOUR BEDS (WHIRLWIND, AUTOQUEST APEX)

The front double bed is made up by lifting the two side beds up and pulling them together to meet in the centre.

Day and Night

DAY VIEW

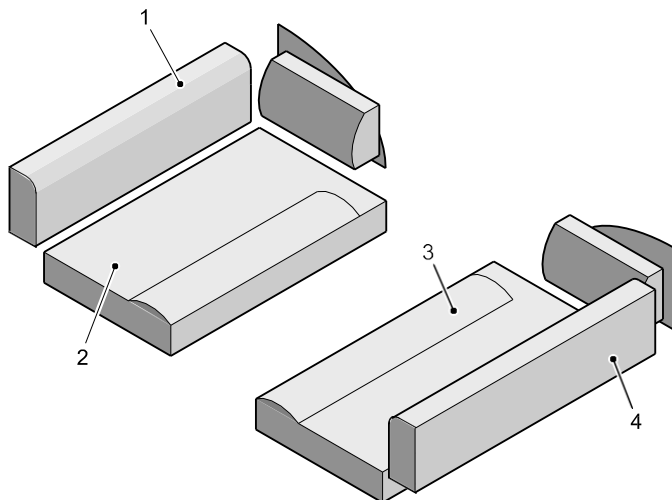

NIGHT VIEW

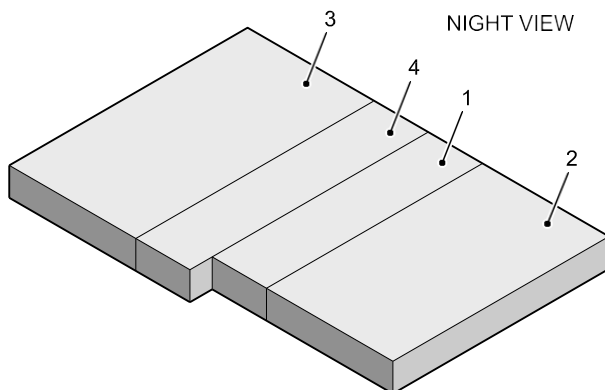

HOW TO USE YOUR MOTORHOME'S EQUIPMENT

HOW TO MAKE UP YOUR BEDS

Day and Night 196

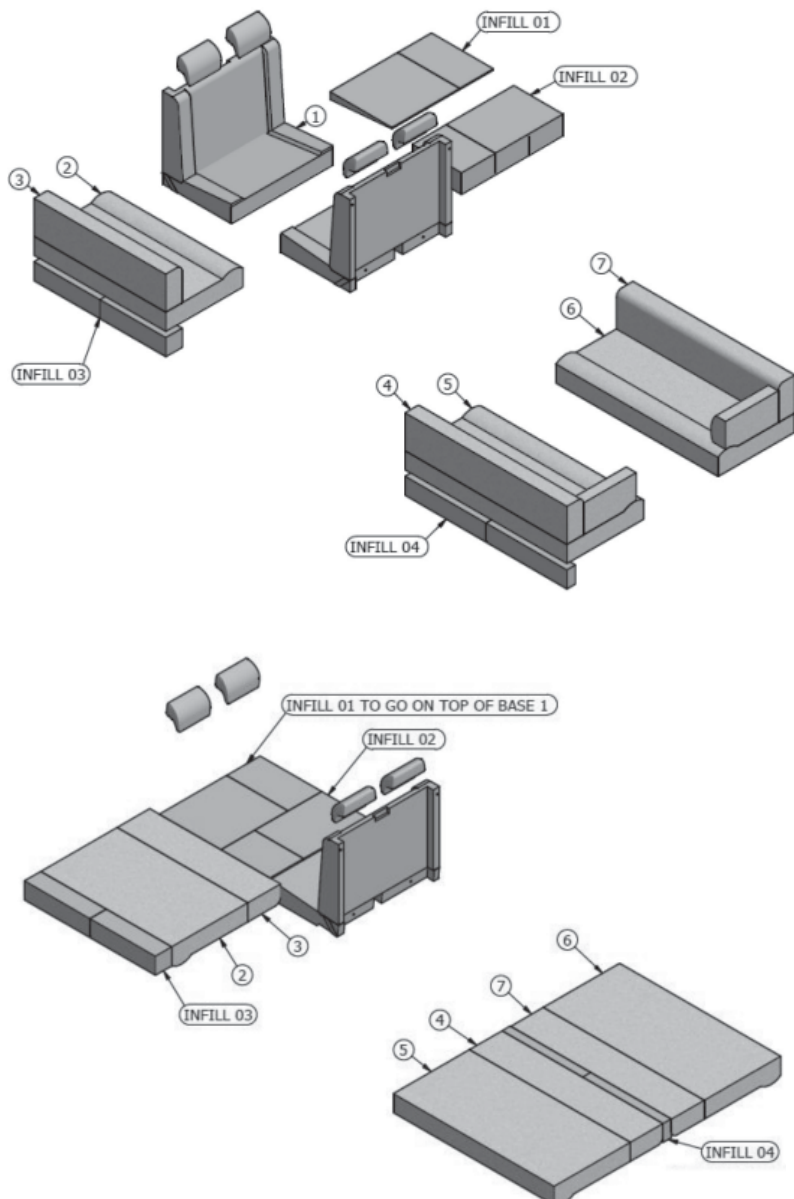

HOW TO USE YOUR MOTORHOME'S EQUIPMENT

Lift Up Bed (196 only)

Description

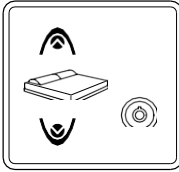

The bed is operated from a small aluminium panel with security key and two buttons, one to move the plane of the bed upwards, the other downwards.

Operation

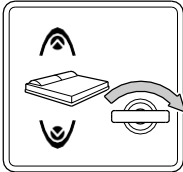

Insert the key into the lock and turn clockwise 90°.

Press the top button to bring up the bed.

The bed moves as long as the button is pressed to lift.

Press the bottom button to lower the bed. The bed moves downward as long as the user holds down the button.

The lifting-bed system is equipped with two limit switches for protection. If, for example, the user depresses and holds the down button for a longer time than that required for the bed to travel its full drop then, a protection device takes over and disables the movement so as not to exit the bed from the guides and also to protect the motor. This protection is replicated for the upward movement.

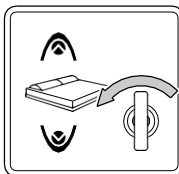

Once the bed reaches the desired position, turn the key to the OFF position, turning it to the left by 90°.

Protection

There are various types of protections.

- The key for isolation of operation
- 2 limit switches, one high and the other low
- Mechanical Movement

The bed-lifting mechanism should only be operated by adults.

Emergencies

Unlocking procedure in case of insufficient power

The electric motor is fitted on the end with a hexagonal nut, which allows manual movement of the plane of the bed in case of insufficient voltage of the vehicle leisure battery. The bed mechanism can be operated manually, if power is disabled, simply by turning the hexagonal nut clockwise or counter clockwise, depending on the desired direction of movement.

CAUTION: The lockers attached to the underside of the lift up bed should not be loaded with more than 7.5kg of payload per locker assembly.

Before lowering the bed for use, ensure the area below is clear of people and obstructions.

Forward and rear facing seat head rests are to be placed in the lowest position.

HOW TO USE YOUR MOTORHOME'S EQUIPMENT

HOW TO MAKE UP YOUR BEDS (WHIRLWIND/AUTOQUEST APEX 105, 120)

The front double bed in the 105 is made up by lifting the two side beds up and pulling them together to meet in the centre.

Day and Night 105

DAY VIEW

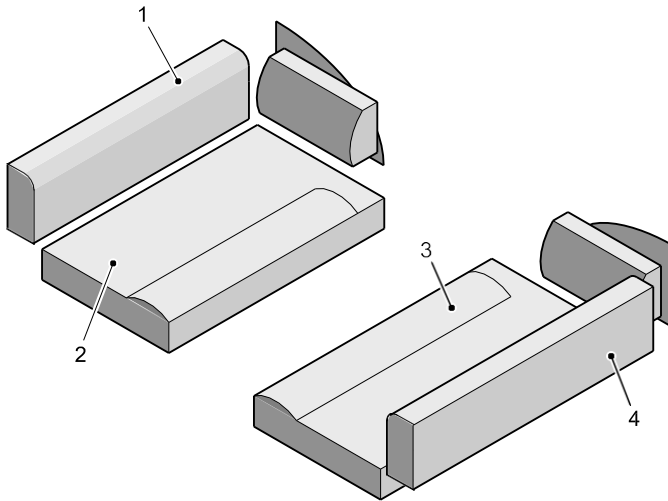

NIGHT VIEW

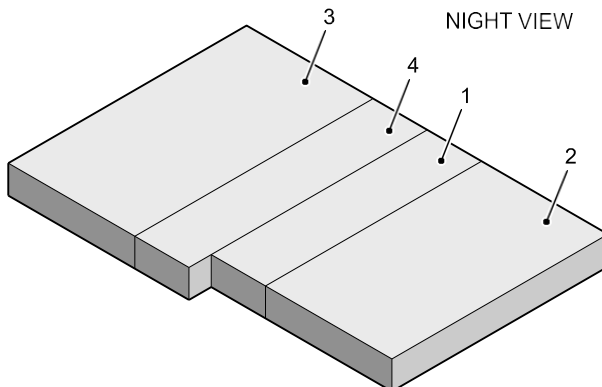

HOW TO USE YOUR MOTORHOME'S EQUIPMENT

HOW TO MAKE UP YOUR BEDS

Day and Night 120

DAY VIEW

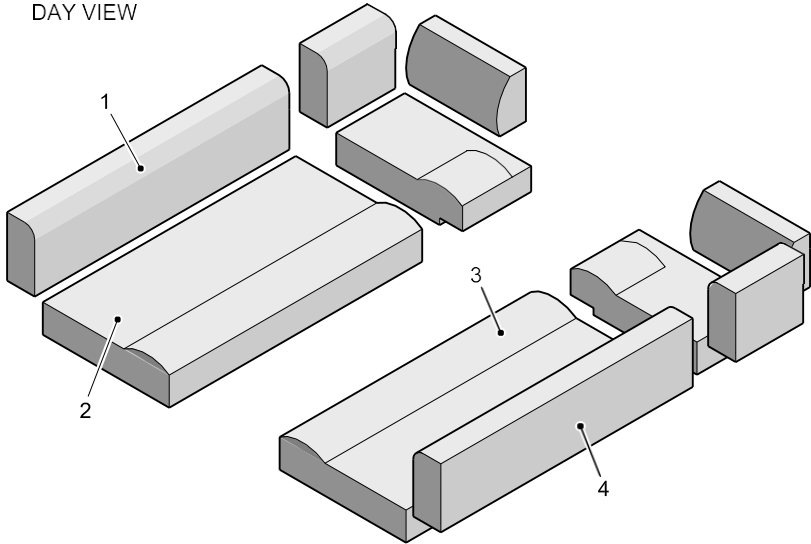

NIGHT VIEW

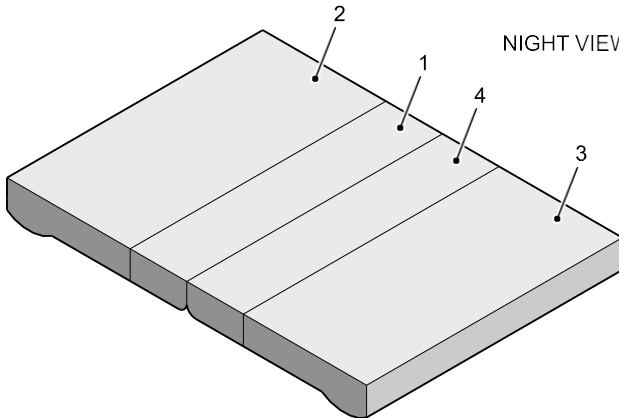

HOW TO USE YOUR MOTORHOME'S EQUIPMENT

HOW TO MAKE UP YOUR BEDS (AVALON/QUANTUM)

Day and Night

The front double bed is made up by lifting the two side beds up and pulling them together to meet in the centre.

DAY VIEW

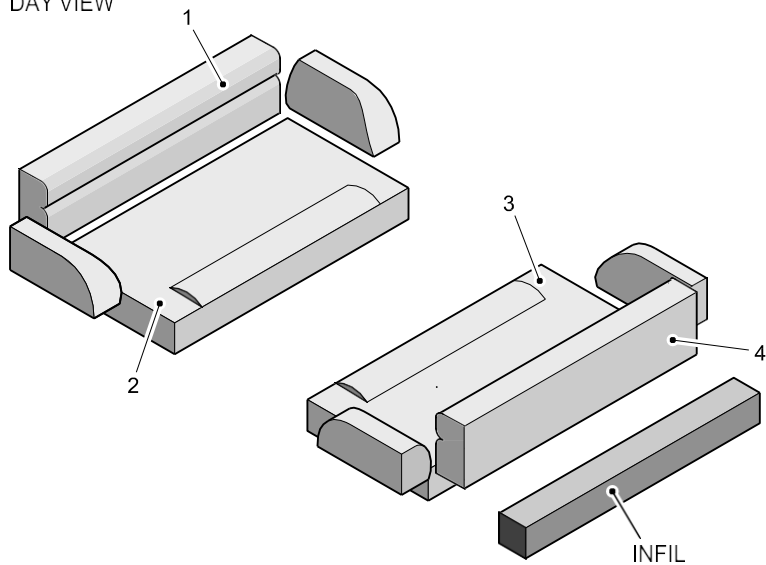

NIGHT VIEW

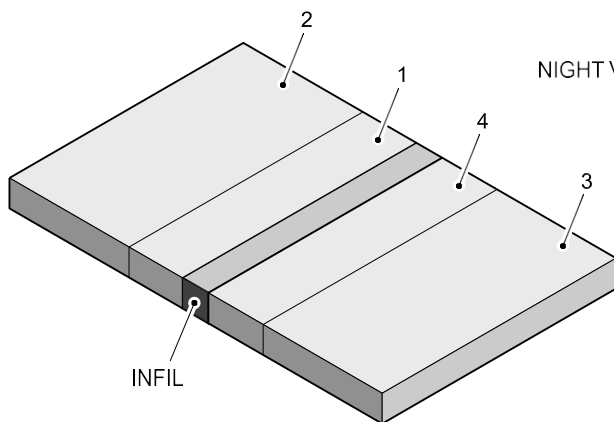

HOW TO USE YOUR MOTORHOME'S EQUIPMENT

HOW TO MAKE UP YOUR BEDS

Day and Night 295

The rear double bed is made up by lifting the two side beds up and pulling them together to meet in the centre.

DAY VIEW

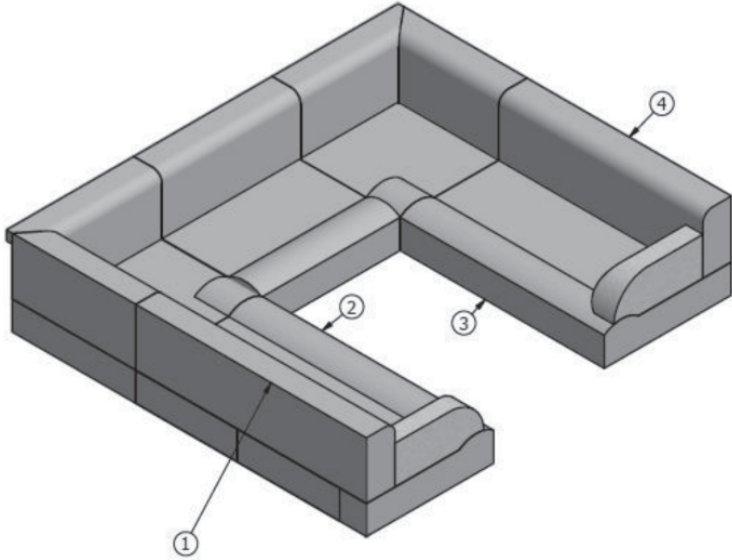

NIGHT VIEW

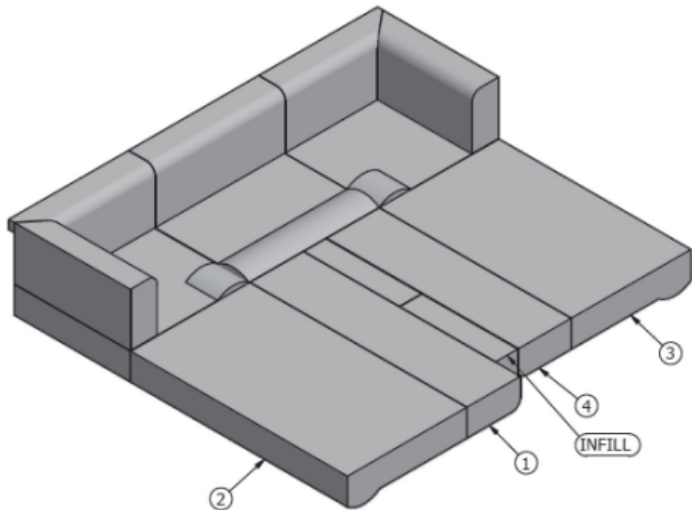

HOW TO USE YOUR MOTORHOME'S EQUIPMENT

Whale Easi-Slide Socket

How to open the socket lid

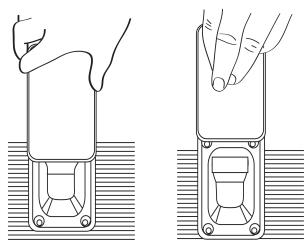

Fig 1

Safety Information

This appliance is **not** intended for use by persons (including children) with reduced physical, sensory or mental capabilities, or lack of experience and knowledge, unless they have been given supervision or instruction concerning use of the appliance by a person responsible for their safety.

- Children **must be** supervised to ensure that they do not play with the appliance.

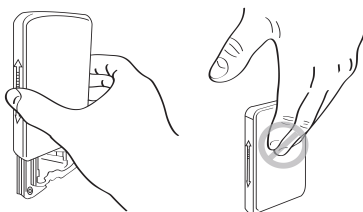

Fig 2

- Any alteration to the appliance, misuse or use of non-original Whale parts may invalidate the warranty. Non observation of the installation and operating instructions will lead to cancellation of the warranty and exclusion of liability claims. It also becomes illegal to use the appliance if incorrectly installed, and in some countries may make it illegal to use the vehicle.

Additional Safety Information for Main In, Mains Out and Multimedia 3 in 1 Sockets (Where Applicable)

All work must be carried out by a competent person as defined by BS7671 Part 2/IEC 60364.

Safety

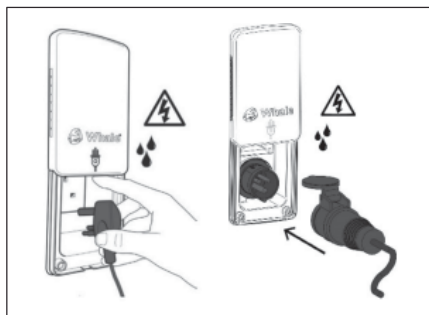

- If the mains in or out supply cord is damaged, it must be replaced by a special cord or assembly available from the manufacturer or its service agent.
- For use in recreational vehicles only.

Additional Safety Information for Onboard Tank Fill, On Board Tank Fill +12v and Water In / Out Sockets (Where Applicable)

- For use in recreational vehicles with a typical water system pressurised up to 3 bar.
- When using the **Water In Socket**, Whale recommends that you keep the o-rings lubricated for easy and secure connection/removal of the plug to socket. Use a water-based lubricant such as silicone grease. **Please note: Do not use vaseline or vegetable oil to lubricate o-rings.**

Additional Safety Information for External BBQ Outlet Socket (Where Applicable)

Whale BBQ sockets including the gas hose connector must be installed and serviced by a Qualified Gas Engineer in accordance with these installation instructions and BS EN 1949-2011.

HOW TO USE YOUR MOTORHOME'S EQUIPMENT

WARNING: Care must be taken when using the external BBQ outlet socket. NEVER barbeque next to an awning or tent.

WARNING: Only for use as an outlet point for gas, never connect a gas bottle directly to the outlet.

In the unlikely event of leaks in the gas system, or if there is a smell of gas:

- Extinguish all naked flames
- Switch off all appliances and do not operate any electrical switches
- Turn off all gas appliances
- Open windows and doors for ventilation
- Do not smoke
- Shut off gas connection
- Immediately ensure that the system is thoroughly checked by a **Qualified Gas Engineer**.
- Regularly inspect gas tap to ensure inside nozzle is free from debris, and gas connection to the rear has not been damaged.

HOW TO USE YOUR MOTORHOME'S EQUIPMENT

Mobile Internet (Option)

If this option is applicable, your router has already been installed in the optimum position within your vehicle. The location of the internal router may vary depending on vehicle layout. The information below outlines the basic setup and how to get online. For more detailed information, please refer to the manufacturers operating instructions supplied with your vehicle.

Get to know your Router

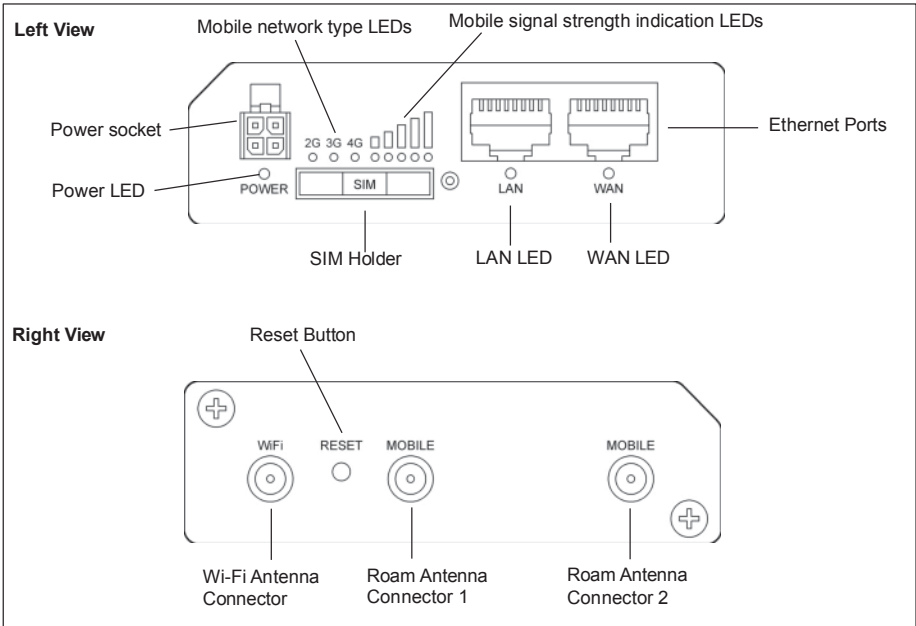

Credential Router Sticker (located on the reverse of the Router)

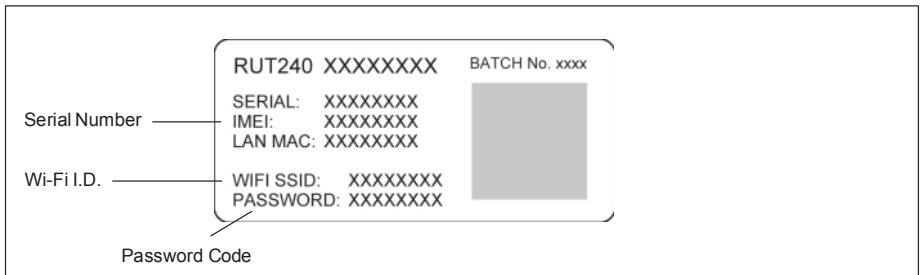

HOW TO USE YOUR MOTORHOME'S EQUIPMENT

Getting Online

Now your Roam is installed and you have inserted the SIM card, its time to get connected. To do this, you will need to be using a device which can connect to a Wi-Fi network such as a smart phone, Smart TV, tablet or laptop.

Turn on router and allow 2 to 3 minutes for the router to boot.

When ready, the router name will be visible in your devices Wi-Fi settings.

Device Settings

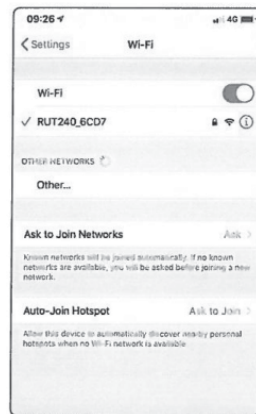
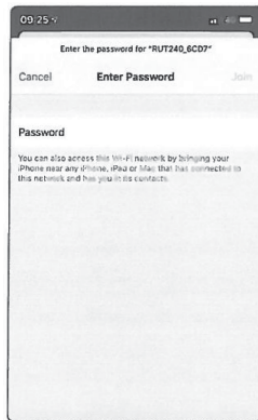
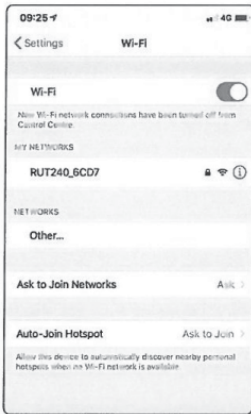

1. Navigate to your devices Wi-Fi settings and view available Wi-Fi networks.
2. The Roam router will be displayed as RUT240_XXXX. The last 4 characters will be unique to your Roam router.

If more than one Roam is being used within close proximity, the Wi-Fi network name is displayed on the back of the router.

3. Once you select this network, you must enter the password. This is also printed on the back of the router.

Note: Password is case sensitive

1. You are now connected and can begin using your Roam.

HOW TO USE YOUR MOTORHOME'S EQUIPMENT

Factory Reset

At any time, the Roam router can be reset to its factory settings using the reset button on the side of the router. This will restore all settings on the router, including:

- Router SSID (network name) and password to those listed on the back of the router.

- Web User Interface to the username and password listed on the front of the router.
- All custom settings will be deleted, including any Wi-Fi connections you may have added.

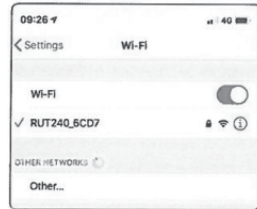
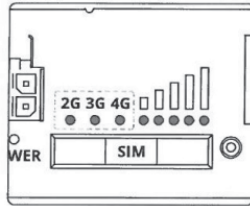
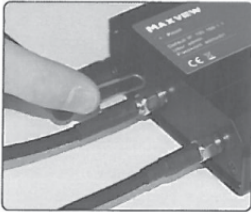

1. To complete the factory reset, press and hold down the reset button with the supplied pin needle.

2. Hold for 6 seconds, until all of the green LEDs on the side of the router are on.

Once released all 5 signal strength LEDs will flash together.

This indicates the start of the reset process.

Note: If you don't hold long enough, the router will restart but not reset.

3. Allow 3 minutes for the router to reset. Once reset the Wi-Fi network will be visible and available to connect to.

HOW TO USE YOUR MOTORHOME'S EQUIPMENT

Pop-up Wireless Charging and USB Device (Avalon/Quantum)

Your vehicle is fitted with a wireless charging device, as shown in the image below.

Your device must contain wireless charging technology to be compatible with this charging station. Your device can be charged on this charger both in the extended or stowed position, by simply placing your device onto the charging pad.

The soft touch pad is spring loaded and can be pressed to either extend or retract the top of the charging station. When in the extended position, two USB ports become visible and can be used for additional hard wired charging or to interact with any other device as necessary.

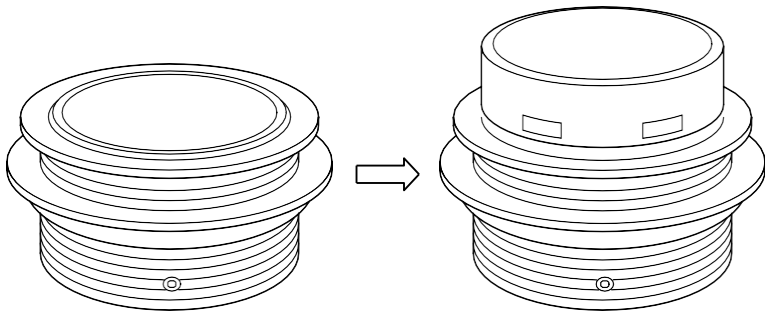

POP - IP SYSTEM

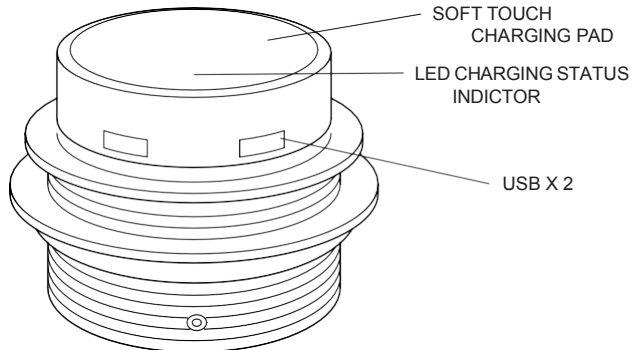

HOW TO USE YOUR MOTORHOME'S EQUIPMENT

ISOFIX Child Seat Restraint (Where fitted)

Your vehicle is fitted with ISOFIX anchor points that accommodate universally provided ISOFIX child seats. These points are located on the forward facing travel seats & seat frame.

The ISOFIX system comprises of two rigid attachment arms on the child seat that attach to anchor points on the rear of seat frames. Located where the cushion and backrest meet.

For ISOFIX child seat installation please refer to child seat manufactures fitting instructions.

Fixed travel seat headrest (Where fitted)

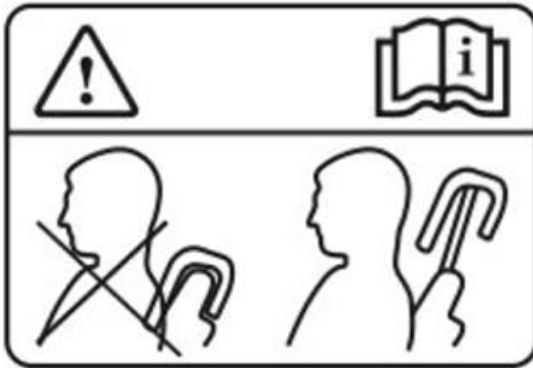

The headrest must be locked in a user – position while driving.

HOW TO USE YOUR MOTORHOME'S EQUIPMENT

Air Conditioning (Where fitted)

Symbols used

 The device must only be installed and repaired by an expert.

 Symbol indicates possible hazards.

 None containing information and tips.

Safety Instructions

 Only competent and trained persons (experts) may install, repair or perform the function check on the Truma product in accordance with installation and operating instructions and the currently accepted technical regulations. Experts are persons who, based on their specialist instruction and training, their knowledge and experience with Truma products and the relevant standards, can carry out necessary work properly and identify potential hazards.

This appliance may be used by children from 8 years old and by persons with disabilities or with lack of experience only if they are supervised or have been instructed in the safe use of the appliance and understand the resulting risks.

Children must not be allowed to play with the appliance.

The power supply must be disconnected from the mains (all poles) before opening the housing.

The device fuses and connection cables must only be replaced by experts.

The 230 V.T 6.3 A H (slow) device fuse can be found on the electrical control unit in the device and must always be replaced with an identical fuse.

In particular, the following will render warranty and guarantee claims void and lead to exemption from liability claims:

- Modifications to the appliance (including accessories).
- Using replacement and accessory parts other than original Truma parts.
- Failure to follow the installation and operating instructions.

The appliance's operation permit, and consequently also vehicle's operating permit in some countries, are also rendered void.

The refrigerant circuit contains R 407C refrigerant and must be only opened **in the factory**.

The air inlets / outlets at the external unit and the air distributor must not be obstructed under any circumstances. This is essential in order to ensure that your device operates correctly.

To prevent damage to the appliance, it should not be operated continuously at an incline of more than 8%.

Do not operate the device in cooling mode for long periods with the vehicle at an angle, since the condensation that is produced may not be able to run away and may penetrate the vehicle under unfavourable circumstances.

In order to ensure that the equipment works properly and to avoid damage, only power supply sources with a purely sinusoidal wave from (e.g. voltage converter, generator) and without voltage peaks must be used.

When the vehicle is being cleaned it must be ensured that no water gets into the device when spraying with a high-pressure cleaner, for example (do not spray directly into the openings of the device).

Hot cleaners and steam cleaners must **not** be used.

The condensation traps must be clear at all times during operation.

Notes on using air conditioning systems

The air conditioning system is designed for a power consumption of up to 4.2 A. You should still check whether the camp site has adequate fuse protection (min. 6 A) before starting the equipment up.

Park the vehicle in the shade if possible.

Darkening the blinds reduces the amount of heat radiation.

Clean your roof at regular intervals (a dirty roof heats up more than a clean roof).

The vehicle must be properly ventilated before starting the equipment in order to remove accumulated warm air from the vehicle.

In order to obtain a healthy room climate, the difference between the inside and outside temperatures should not be too great. The recirculated air is cleaned and dehumidified during operation. A pleasant room climate is produced by drying the moist air, even with small temperature differences.

Keep all doors and windows closed when in cooling mode so that no condensation forms on the air distributor.

For faster cooling or heating:

- Set fan level to high.
- Set front / rear air distribution to center position.
- Set floor / ceiling air distribution to ceiling.

Operating Instructions

i Operating instructions can be viewed in offline mode with a mobile device and the Truma App. Download the operating instructions when you have WIFI connections and save them to your mobile device.

i The symbols in the display are visible depending on the settings.

Remote control

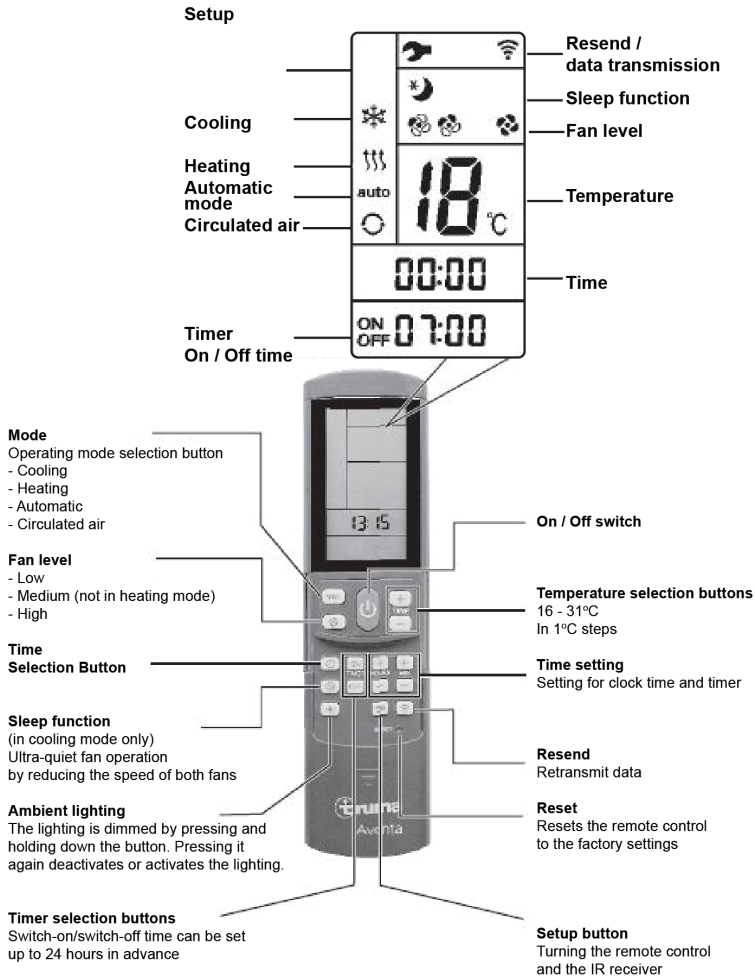

Figure 1

HOW TO USE YOUR MOTORHOME'S EQUIPMENT

Start-up

The air conditioning may only be operated via the vehicle's own power supply (battery, inverter).

Before switching on, be sure to check that the vehicle has adequate power supply fusing (230 V).

The remote control must always be pointed at the infrared receiver in order to perform the individual switching commands.

Before switching on for the first time, the remote control must be tuned to the IR receiver.

- Insert batteries (pay attention to polarity)
- Setup symbol flashes (if symbol does not flash, perform Reset)
- Point remote control at IR receiver
- Press Setup button and hold down
- When the red LED on the IR receiver starts to flash, release the Setup button.

The remote control is tuned to the IR receiver, the Setup symbol goes off and the air conditioning system starts in circulated air mode, at low fan level and with no timer set.

Switching on

Switch on the air conditioning system using the "On / Off switch" of the remote control. The last selected settings are taken over.

 The circulated air fan runs after switching on. The compressor switches itself on after no more than 3 minutes, and the blue (cooling) / yellow (heating) LED flashes.

Temperature

If necessary, use the "Temperature selection buttons" to set the required room temperature with "+" and "-".

Mode

Select the required operating mode by pressing the "MODE" button one or more times.

- Cooling
- Heating
- Automatic (cooling or heating mode, depending on the room temperature setting)
- Circulated air

When the room temperature that was selected using the remote control is reached in **cooling mode**, the compressor switches off and the blue

LED in the IR receiver goes off. The circulated air fan continues to run in order to provide ventilation. If the room temperature setting is exceeded, the device automatically reverts to cooling mode.

 The air is dehumidified during cooling. If the air humidity in the vehicle is extremely high at the beginning of the cooling procedure, moisture can build up on the underside of the air distributor. The doors and windows should therefore be kept closed and the highest fan level selected.

When the room temperature that was selected using the remote control is reached in **heating mode**, the compressor switches off and the yellow LED in the IR receiver goes off. The circulated air fan continues to run in order to provide ventilation. If the temperature drops below the room temperature setting, the device automatically switches to heating mode.

 Heating at an outside temperature of less than 4°C is not possible because heating performance falls considerably. Between 4°C and 7°C the device switches briefly to defrosting processes. At above 7°C there are no restrictions on heating mode.

In **automatic mode**, cooling / heating mode and the fan level are selected automatically depending on the room temperature.

In **circulated air mode**, the interior air is recirculated and cleaned by the filters. No LED's illuminate in the IR receiver.

Fan

Select the required fan level by pressing the "Fan level" button one or more times.

Fan level (not functional in automatic mode):

- low
- medium (not in heating mode)
- high

Sleep function

In "sleep function" (cooling mode only), the internal and external fans operate at slow speed and therefore extremely quiet.

Switching off

To switch off, press the "On / Off switch" on the remote control. The remote control and the device are switched off. The light can still be switched on and off using the "Ambient lighting" button.

HOW TO USE YOUR MOTORHOME'S EQUIPMENT



If the air conditioning system is switched on again, the blue / yellow LED flashes. The circulated air fan runs, and the compressor switches on after no more than 3 minutes.

Time

Press the **"Time selection button"** and set the current time using the **"Time setting"** buttons.

The time is always shown on the display (exception with ON / OFF timer).

The time must be reset after changing the batteries or after a daylight saving time change.

Timer ON / OFF

The on / off time of the air conditioning system can be set in advance for a minimum of 15 minutes to a maximum of 24 hours, starting from the current time, using the integrated timer.

The device must be switched on using the remote control in order to program it.

Set required operating mode and room temperature.

Then select TIMER ON or TIMER OFF using the **"TIMER selection buttons"**. Set the required On / Off time using the **"Time setting"** buttons (15 minutes to 24 hours) and **confirm** with TIMER ON or TIMER OFF.

Pressing the relevant timer button again deactivates the timer function.

Ambient lighting

Irrespective of whether the air conditioning system is operating, the lighting in the air distributor can be switched on or off by pressing the **"Ambient lighting"** button. The lighting is dimmed by pressing and holding the **"Ambient lighting"** button. The previous setting is activated when it is switched on again.

Reset

Resets the settings of the remote control to the factory setting when pressed using a ballpoint pen, for example. Set up symbol flashes.

Resend

The previous settings are resent.

Setup

Tune the remote control to the air conditioning system that is going to be operated.

IR Receiver and manual on / off

There is an additional pushbutton on the IR receiver (m), with which the unit can also be switched on and off without the remote control (e.g. with a ballpoint pen).

If the unit is switched on using this pushbutton, the system is automatically reset to the factory settings (automatic mode, 22°C).

IR receiver / function display

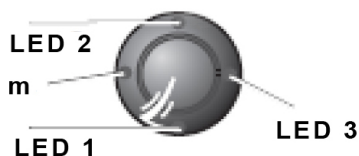

Figure 2

LED 1 blue – illuminated – (cooling mode)

LED 1 blue – flashing – (heating mode compressor start-up)

LED 2 yellow – illuminated – (heating mode)

LED 2 yellow – flashing – (heating mode compressor start-up)

LED 3 red – flashing – (data transfer in progress)

LED 3 red – illuminated – (fault)

Red LED illuminated

The device is indicating a fault. Switch device off, wait for a short time and switch on again. If the red LED continues to illuminate, please contact the Truma Service Centre.

Air Distribution

Right / left

There are two individually adjustable air outlets at the front and rear.

Front / rear

The air flow can be metered between the front and rear areas of the vehicle.

Ceiling / floor

The air flow can be directed from the ceiling to the floor.

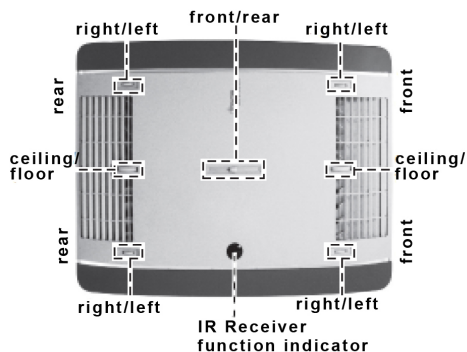

Figure 3

IR remote control battery change



The tuning between the remote control and the air conditioning system is retained if the batteries are removed.

Only use micro-batteries that will not leak, type LR 3, AM4, AAA, MN 2400 (1.5V).

The battery compartment is on the back of the remote control.



When inserting new batteries, make sure the positive / negative terminals are connected correctly.



Empty, used batteries can leak and damage the remote control! Remove the batteries if the remote control is not being used for a long period of time.

Figure 4

No warranty is given for damage caused by leaking batteries.

Disposal



Neither the remote control nor the batteries may be disposed of with domestic refuse, instead they must be sent for recycling separately via a collection point. By doing this you are contributing towards reuse and recycling.

Maintenance

Maintenance, repairs and cleaning must not be done by children.

Carry out filter changes depending on the amount of use, but at least every 12 months. Never operate the air conditioning system without a filter. This can lead to loss of power. Keep the air inlets / outlets and condensation traps on the roof free of obstructions such as leaves at all times. The air conditioning system should be only cleaned with a soft, damp cloth.

Disposal

The appliance must be disposed of in accordance with the administrative regulations of the respective country in which it is used. National regulations and laws (in Germany for example, the End-of-life Vehicle Regulation) must be observed.

In other countries, the relevant regulations must be observed.

HOW TO USE YOUR MOTORHOME'S EQUIPMENT

Troubleshooting

Error	Cause / Remedy
Device not cooling	- Thawing procedure in progress - Remote control temperature setting reached or too high
Device not heating	- Thawing process in progress (outside temperature between 4°C – 7°C) - Outside temperature below 4°C
Device cooling / heating inadequately or not at all	- Filter soiled, change filter - External air routes soiled / blocked
Moisture on underside of air distributor	- Close all windows and doors and select high fan level
Water dripping out of air distributor	- Condensation trap on external unit blocked - Seal between device and roof not intact - System at too much of an angle
Remote control not working	- Check batteries in remote control and replace if necessary
Device not reacting to remote control commands	- Check whether there are obstructions between the remote control and IR receiver - Is the remote control tuned to the IR receiver? / Tune remote control to IR receiver.

If these actions do not remedy the problem, please contact Truma Service.

Solar Panel Regulator (Where fitted)

Safety Instructions



To protect you from electrical shocks, injury or burns the following basic safety principles must be observed when using electrical devices. Please read and follow these instructions before using the device.

Installation

Ensure that the devices are fixed with all 4 mounting holes safely and cannot fall. Always position the cables to ensure they do not pose a tripping hazard. Do not expose electrical devices to rain. Do not operate electrical devices in damp or wet environments. Do not operate electrical devices close to flammable liquids or gasses.

Protection against electrical shocks

Only operate devices with undamaged casings and cables. Ensure the cables are installed safely. Do not pull on the cables.

The solar panel generates power when light is cast on it. The full voltage is also available even if there is little light. The open circuit voltage may be twice as high. Do not touch any live parts. Cover solar modules with e.g., cardboard, before mounting and installing, or disconnecting.

Use

This device has not been designed for use by people (including children) who have restricted physical, sensory, or mental abilities or a lack of experience and/or knowledge, unless they are supervised by a person responsible for their safety or have received instructions from that person as to how the device is to be used.

Children should be supervised to ensure they do not play with the device.

Do not use electrical devices for purposes other than those stated by the manufacture. The ventilation slits in the housing must be free and may not be covered by luggage, towels, or clothing etc.

Caution

Batteries may generate explosive gases during charging and operation. Keep away from flames and ignition sources. Ensure these is sufficient ventilation in the battery chamber.

Repairs

Do not repair or modify the device. Please contact your dealer or the Truma Service see www.truma.com or 01283 587960.

Accessories

Only use accessories and additional device that are supplied or recommended by the manufacture.

Intended use

Increased capacity with manufacture's written approval. The solar dual battery charger controller only serves to charge 12vDC lead accumulators comprising 6 single cells (for example leisure battery) with a capacity of 80 – 110* Ah (SDC12) or 80 – 200** Ah (SDC25). The device was developed for connection to solar modules. Only use suitable modules for example Truma SM 25, 40, 65, 80, 100, 120, 150 or 180. Observe the maximum voltage and power draw values. The preferred application fields for the automatic charger are batteries with gel, AGM or liquid electrolyte.

The device is designed for installation a dry indoor environment.

Improper use



The device is not suitable for charging.

- 6 V batteries or 6 V Lead accumulators
- non-chargeable batteries
- nickel-cadmium batteries

If batteries with a rated voltage of 6 V are charged with the device, gassing occurs immediately. An explosive gas can be created.

The device is only suitable for regulating solar modules. Do not connect any other voltage sources (for example main voltage 230vAC or 24vDC) to the device. This may destroy the device and/or sources. If any other voltage sources are used together with the device, please ask your dealer.

HOW TO USE YOUR MOTORHOME'S EQUIPMENT

Battery care (also, maintenance-free batteries)

The following points should be observed to extend the battery life:

- Batteries should be fully charged before and after being used.
- In the case of longer standstills (without sunshine), disconnect the battery and charge separately for 24 hours at the latest every 12 weeks.
- Note: before disconnecting a leisure battery or vehicle battery, a competent person must first switch off any central control (power distribution) device and remove the charge controller supply fuse OR cover the solar panels to prevent power generation.



Store fully charged batteries in a cool but frost-free place during the winter and recharge regularly (every 12 weeks).

Device elements

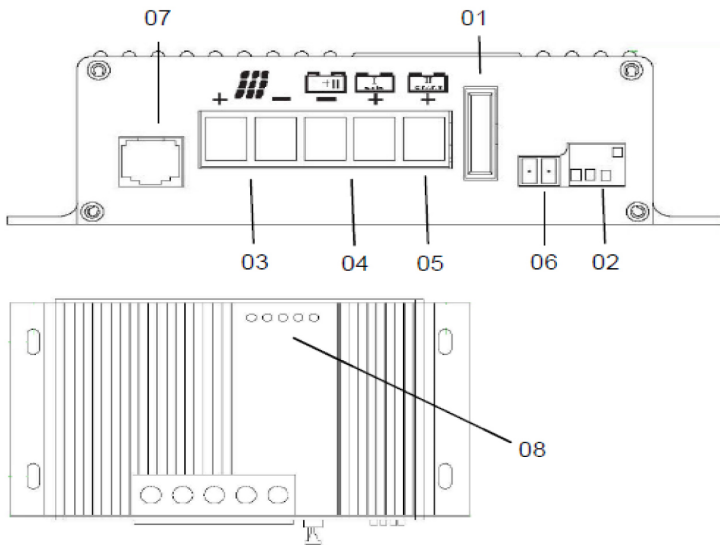

Fig 1: Device elements

- 01** Main Fuse 20amp SDC12 – 40amp SDC25
- 02** DIP switches for battery type selection
- 03** Solar input terminals – positive & negative
- 04** Main battery output terminals – positive & negative
- 05** Starter battery output terminal – positive only
- 06** Temperature sensor socket (sensor optional)
- 07** LCD meter socket (LCD meter optional)
- 08** Status indication LED's

HOW TO USE YOUR MOTORHOME'S EQUIPMENT

Function

The device is a MPPT, or maximum power point tracker, an electronic DC to DC converter that optimizes the match between the solar panels (PV panels) and battery. This allows high performance combined with a light weight and small dimensions. By virtue of the high-quality electronics, it works highly efficiently. The automatic charging process preserves the device and does not overcharge the batteries. This in turn extends the service life of the batteries. This in turn extends the service life of the batteries significantly. It is suitable for batteries with liquid, gel or AGM technology and has settable charging current distribution for two separate battery connections.

The device is capable of continuous operation and parallel mode. Consumers can be continuously connected, switched on or disconnected. Consumers are supplied and the batteries are charged at the same time via the battery. The consumer current here should be smaller than the solar charging current as otherwise the battery will not charge.

If the device is operated in conjunction with an external temperature sensor for the supply battery (battery 1), the device regulates the charging voltage automatically depending on the battery temperature. This ensures particularly effective and gentle charging of the battery. If an external temperature sensor is not used, the device regulates the charging process based on the internal temperature sensor.

The supply and starter batteries can be charged by connecting one or several solar modules. Please observe the maximum voltage and power consumption values detailed on the controller reverse. This type of connection should be completed in parallel.

Charging process

The device has an electronic reverse input voltage, reverse current and solar short-circuit protection. The charging current is only released (see "charging diagram") if the battery is connected correctly and there is enough power available from sunlight. When a temperature sensor is used, charging takes place in a temperature-dependent basis.

Boost phase

Charging with maximum available solar charging current until the charging end voltage is reached.

Floot phase

The charging voltage is set to 13.8v for GEL type, see battery charging table for other types. The charging current drops to the value necessary to compensate the self-consumption of the battery. Power is still supplied to the consumers via the battery. If the consumed current exceeds the available solar charging current, the charging process can no longer be maintained.

If the battery voltage drops below the selected battery type voltage, the device automatically switches to the boost phase, if there is adequate solar charging current.

Partially Discharged Batteries

(only for AGM and liquid electrolyte battery type)

In contrast to other battery types, batteries on lead basis do not have any harmful memory effect. Consequently: In case of doubt, partially discharged batteries must be charged fully as soon as possible. Always store only fully charged lead batteries. Recharge them periodically, partially in case of used (older) batteries and higher temperatures.



- Liquid electrolyte batteries can create explosive gases, so ensure there is adequate ventilation. Check the liquid level at regular intervals. Over charging can damage your battery; check the technical data for your battery.

In case insufficient solar power and/or high current consumption, the battery should be subject to occasional full charging by means of a mains supply charger.

Overvoltage Protection

The 12v solar controllers protect themselves against connection of excessive battery voltage rates or will be switched-off in case of defective additional charging systems, switching threshold 15.0-16.0v.

HOW TO USE YOUR MOTORHOME'S EQUIPMENT

Overvoltage Limit

Sensitive consumers are protected by means of limitation of charging voltage to maximum 14.8v during all modes of charging/battery type.

Battery Type Selection

Operation

On the Charge Controller bottom face, the battery type DIP switches and battery type table are found. Confirm the type of battery being fitted and arrange the DIP switches to its corresponding configuring.

Battery type

The battery type can only be set for Main Battery 1. Starter Battery is only supported by trickle charging to a maximum 1amp in all settings.

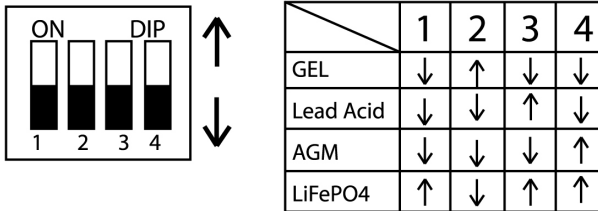

ATTENTION: Only connect LiFePO4 batteries with integrated BMS!

Note: The possible parallel/floating operation with consumers being connected to the battery is also automatically considered by all charging programs.

Charging Parameters

Battery Type	Boost Charging Voltage	Float Charging Voltage	Default Temperature
GEL	14.3 volts (3-10 hours)	13.8 volts	20°C
Lead Acid	14.4 volts (1.5 - 6 hours)	13.45 volts	20°C
AGM	14.7 volts (1.5-5 hours)	13.5 volts	20°C
LiFePO4	14.4 volts (0.5 - 3 hours)	13.8 volts	20°C

Charging Process

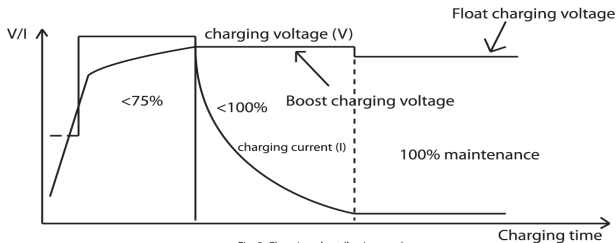

Fig. 2: Charging chart (basic curve)

HOW TO USE YOUR MOTORHOME'S EQUIPMENT

Function display / troubleshooting

On the Charge Controller front face, status LED's are positioned. The following table details the indicating condition of each LED.



Display	Status
Batt Low - illuminated	<ul style="list-style-type: none">• Main battery voltage is below 10.5 volts• Discharged battery• Insufficient battery connection• Failed supply fuse
MPP - illuminated	<ul style="list-style-type: none">• CC Charging
MPP - short flashing	<ul style="list-style-type: none">• CC ready to charge
>80% - illuminated	<ul style="list-style-type: none">• Main battery is almost fully charged
>80% - flashing 1 pulse/sec	<ul style="list-style-type: none">• CC over-heated
>80% - flashing 2 pulse/sec	<ul style="list-style-type: none">• Main Battery or solar panel overvoltage
Batt Full - illuminated	<ul style="list-style-type: none">• Battery (batteries) are fully charged
All LED flashing	<ul style="list-style-type: none">• Battery selection is incorrect

Maintenance

 The power supply must always be disconnected before performing any maintenance work. A competent person must first switch off any central control (power distribution) device and remove the charge controller supply fuse OR cover the solar panels to prevent power generation.

Clean the device with a dry and lint-free cloth.

Bike Rack – (Where fitted)

- The Carry-Bike PRO M is an universal bicycle carrier for vehicles with flat rear walls available. It is supplied with Bike-Block Pro S blocking system and Rail Quick Premium, it is standard delivered for the transport of 2 bicycles. Do not to exceed the max. Weight of 60 kg.
- If you exceed the maximum permitted weight, the braking distance of your vehicle will be increased. Check before you leave.
- Setting the Carry-Bike on rear axis of the vehicle, the standard weight distribution on two axis could be modified; be sure that it doesn't exceed the maximum permitted load (verify the data on your own logbook).
- Never exceed the maximum permitted length and the total weight of the full load vehicle.
- Do not cover the number plate or lights. Repeat lights and plate in case the Carry-Bike covers them, even partially.
- Before installation, clean carefully the area where the bicycle rack will be mounted and use rubber protections in order to avoid any friction, and, consequently any damages to the body/paint of the vehicle. Periodically check rubber parts and, in case they are porous or worn, immediately replace them. If not used for long periods, we suggest to remove the Carry-Bike from the vehicle.
- Make sure that the support brackets are located where they cannot move or shift sideways. They also must not touch the roof of the vehicle, the hinges and the corresponding bolts or screws.
- Periodically check the bicycle rack to make sure its firmly attached, especially during the first 10km. Make sure the belts are not loose and that the holding brackets have not shifted.
- In case you use the bike cover, pay attention that it is duly fixed and does not cover the lights. Detachable parts like child safety seats, bags or air compressor have to be uncoupled and put away inside the vehicle.
- Bicycles have to be fixed both with two Quick-Safe (one piece per wheel) and Security Strip on the frame. Both Quick-Safe and Security Strip have to be periodically checked. In case of damage, they have to be immediately replaced.
- For extra safety travelling, we suggest using steel cable antitheft device.
- While fixing the bikes, verify that there is enough distance between handlebars and/or pedals and vehicle's wall, to avoid compromising the painting.
- Do not exceed the maximum weight allowed.
- The load must be evenly distributed (the heaviest bike must be places near the wall of the vehicle) and must not exceed the maximum width of vehicle.
- In case of using electrical bikes with larger wheels, we suggest the E-Bikes Rail Premium. Besides we suggest using the modular Bike-Block Pro D1 and D2 blocking system for an easier bikes fixing. Do not exceed the maximum weight allowed.
- Be careful when driving and beware of hairpin bends and of gusts of wind. Also keep in mind that you need longer braking distance. Beware dangerous road crossings and garage's entrance. Additional rear view mirrors are required in case of reduced visibility.

HOW TO USE YOUR MOTORHOME'S EQUIPMENT

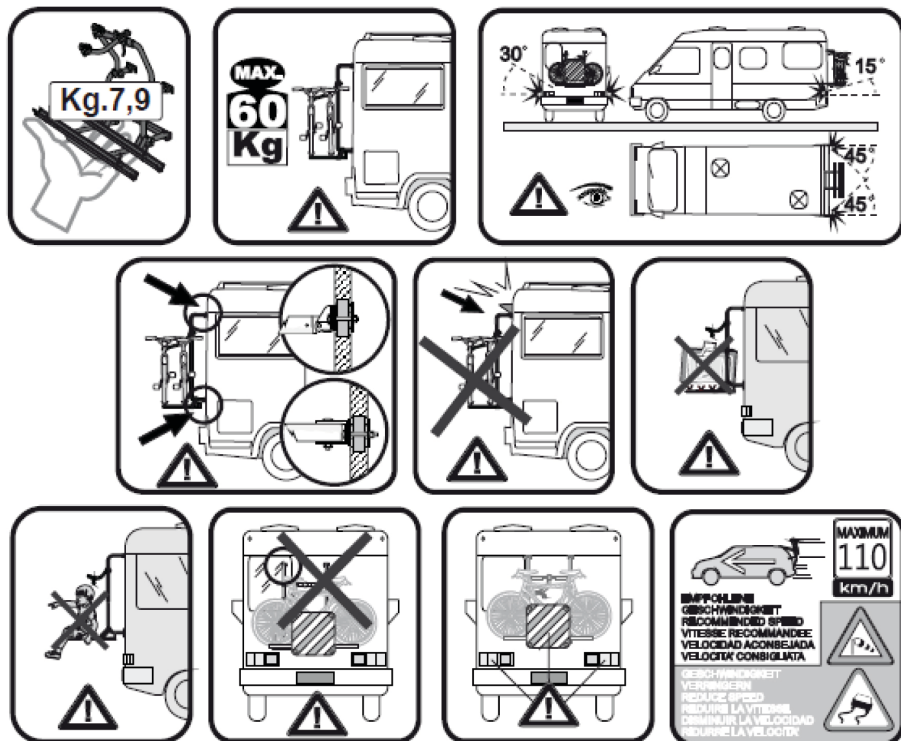

Roll Out Awning (where fitted)

General Safety



WARNING! Failure to obey these warnings could result in death or serious injury.

Health Hazard

- The awning must be installed in accordance with the Domestic installation manual by a qualified technician with sufficient technical knowledge for installing components in vehicles.
- This device can be used by children ages from 8 years and above and persons with reduced physical, sensory or mental capabilities or lack of experience and knowledge if they have been given supervision or instruction concerning use of the device in a safe way and understand the hazards involved.
- Children must be supervised to ensure that they do not play with the device.
- Do not drive the vehicle if the fabric is damaged or torn, even if the awning has been properly retracted. The awning arms are held in place by the fabric. If the fabric rips while driving, the awning will suddenly shoot out. This can lead to serious injury. Secure the awning so that it cannot extend suddenly and unexpectedly while driving.
- Do **not** open the awning while driving.
- Do **not** open the awning in strong winds or snowfall.
- Retract the awning if strong winds, heavy rain or snowfall are imminent.
- Make sure that water or snow does not accumulate on the fabric. Otherwise this could damage the awning or the awning arms could collapse and cause severe injury or fatality.
- Do **not** approach the awning
 - if it was left open during heavy winds
 - if pools of water have formed on it
 - if snow has accumulated on it
 - if any debris is on awning fabric

The awning may move unexpectedly, become unstable and bend or break.

Operating the awning safely



WARNING! Failure to obey these warnings could result in death or serious injury.

Health Hazard

- Do not touch moving parts while operating the awning. There is a danger of injuries from moving parts.
- Before starting your journey, check that the awning is fully retracted. Never move the vehicle when the awning is open.
- Never drive with the crank inserted. Remove the crank before starting your journey.
- Do **not** leave the extended awning unattended. Retract the awning before leaving your locations.
- Keep a safe distance from the awning when having barbecues or open fires. The fabric can be damaged by heat or catch fire.

HOW TO USE YOUR MOTORHOME'S EQUIPMENT

NOTICE! Damage hazard

- Park the motorhome so that no debris (branches, leaves or similar) can get onto the fabric.
- The fabric of the awning should not hang down at the edges but must be taut at all times. If the fabric hangs down, it could rub on the arms and get damaged. The fabric should not sag in the middle with long awnings
- Only retract the awning, when the fabric is free of debris (branches, leaves or similar). Otherwise awning can be damaged when it is retracted.
- Keep the awning free of dirt to prevent abrasions, stains and mildew.
- Only retract the awning if it is wet for safety reasons. Extend it again as soon as possible. Otherwise, mildew or stains can form or the colour may fade.
- Never bend an awning arm or the cover down to drain water off the awning. This can bend the awning and impair its function.
- Do not hang any objects on the awning, on the front cover or the awning arms.
- Do not use any sprays (e.g. insect repellent, hairspray) near the awning. This will soil the fabric or the water-repellent effect of the fabric will be lost.
- If there is insufficient space above the door after the awning is mounted, the door must remain closed when retracting or extending to avoid the door making contact with the arms or the front panel. The required space depends on the design or the door (door width, swing or sliding door) as well as the set awning angle of inclination.

Operating the awning

Note on the vehicle location



NOTICE

- Park the vehicle so that no debris (branches, leaves or similar) gets on to the fabric.
- Keep the awning free of dirt to prevent abrasions, stains and mildew.

Extending the awning



WARNING! Beware of injury

Keep a sufficient distance from objects or other vehicles. Once it is retracted, it should be at least 40 cm away from other objects and vehicles on all sides.

- Proceed as shown (fig.2. to fig 4).



NOTICE! Beware of damage

The fabric of the awning should not hang down the edges, and must remain taut at all times. If the fabric hangs down, it could rub against the arms and become damaged. The fabric used for long awnings may sag in the middle.

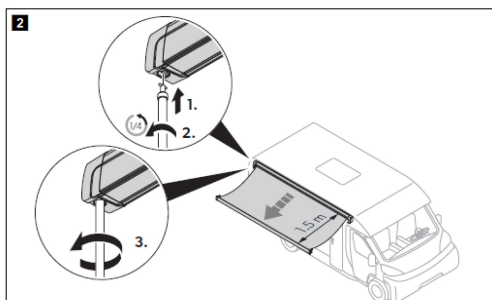

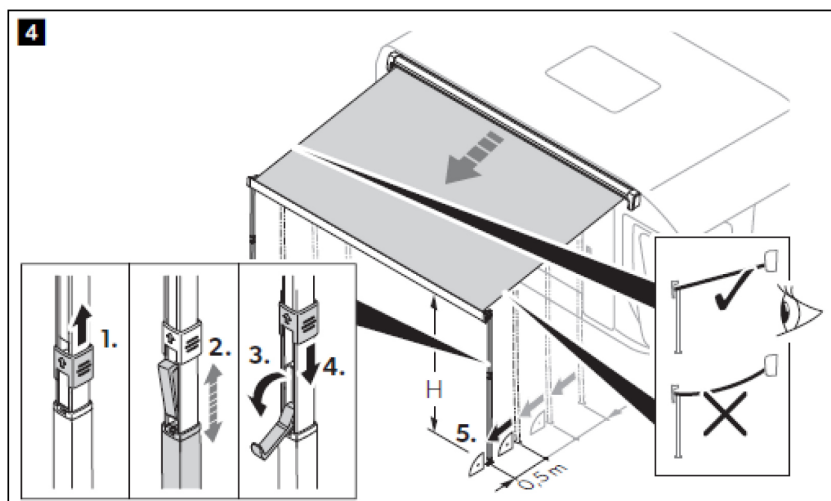
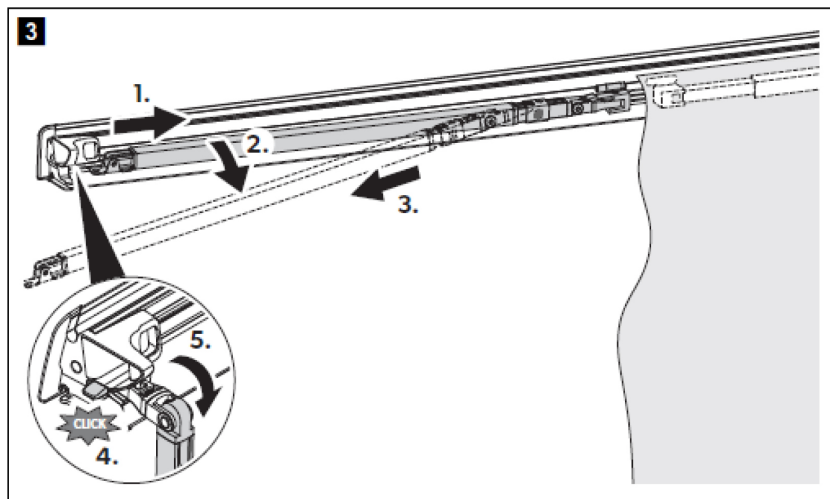

Positioning the support legs on the ground



WARNING! Beware of injury

- Only position the support legs on solid ground
- Secure the support legs from slipping

➤ Proceed as shown (fig.5. to fig 6).

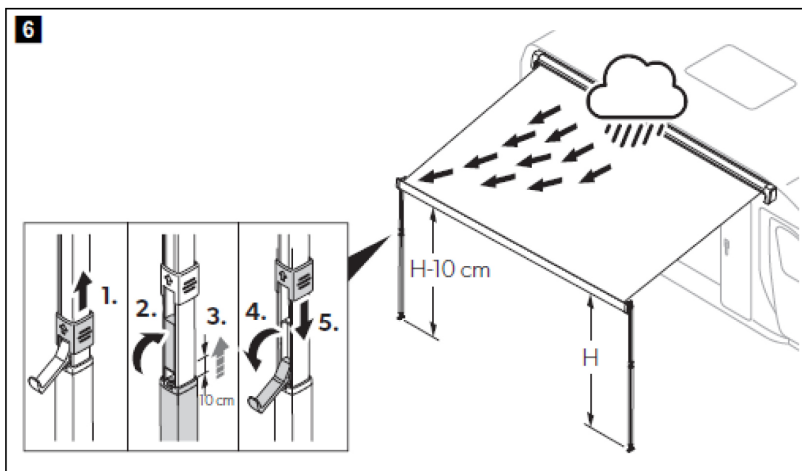
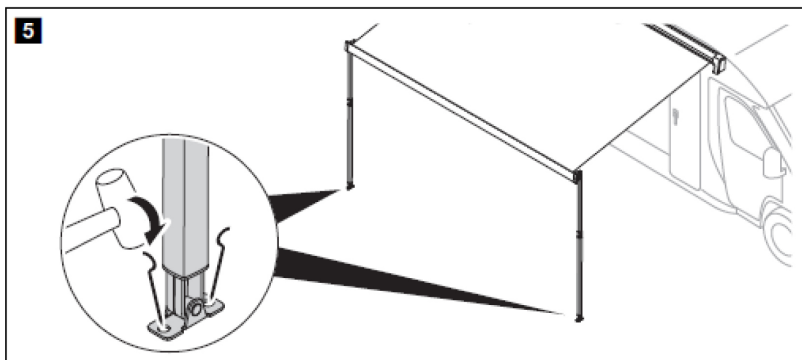

Securing the support legs on the vehicle

You can secure the awning on your vehicle directly if you have already mounted the latches for the support legs.

- Proceed as shown (fig.7. to fig 8).

HOW TO USE YOUR MOTORHOME'S EQUIPMENT

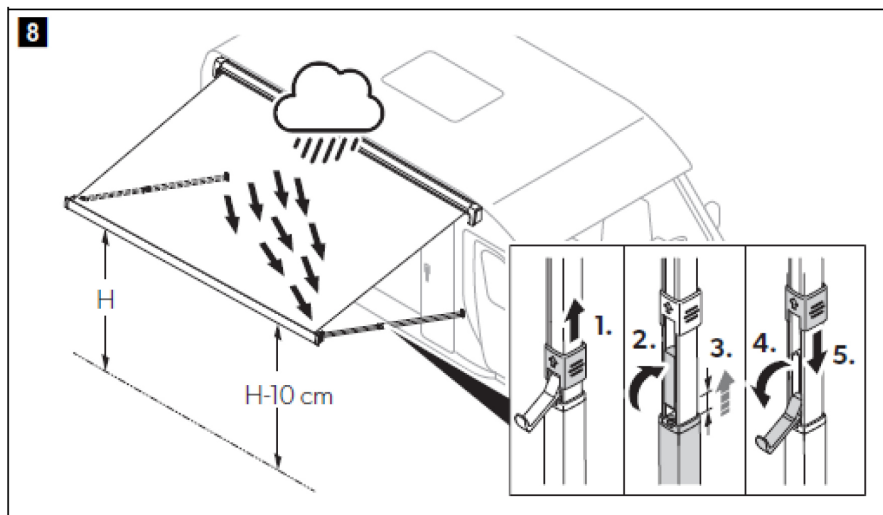
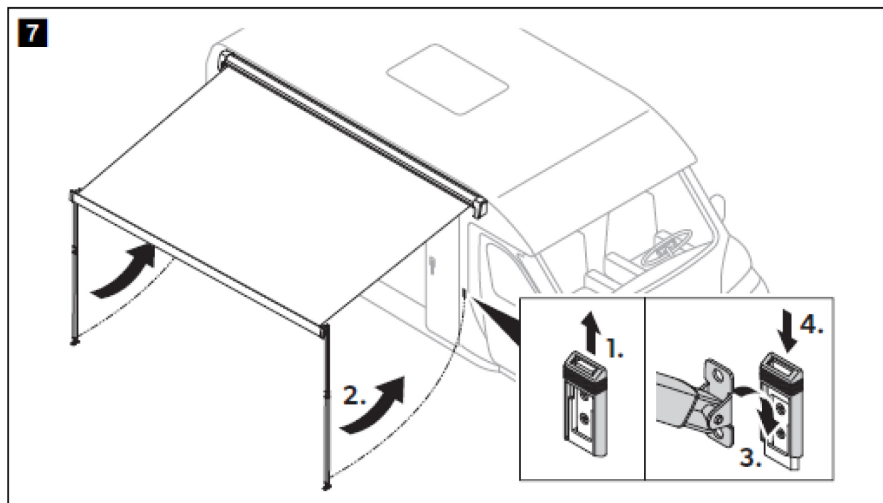

HOW TO USE YOUR MOTORHOME'S EQUIPMENT

Mounting the tension rafter

Awnings with a length of 4 meters or more need to have a tension rafter fitted in the middle of the awning. This prevents the awning from sagging.

- Proceed as shown (fig.9. to fig 10).

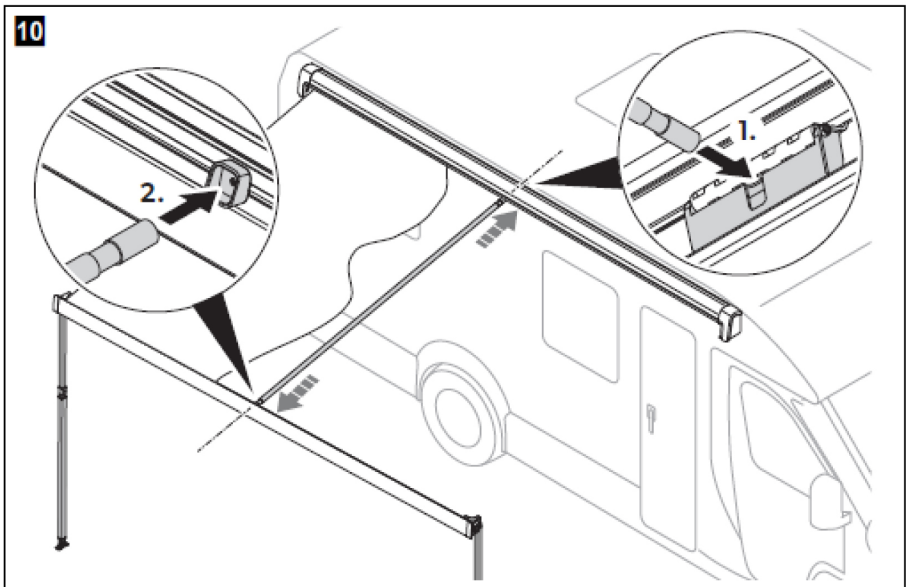
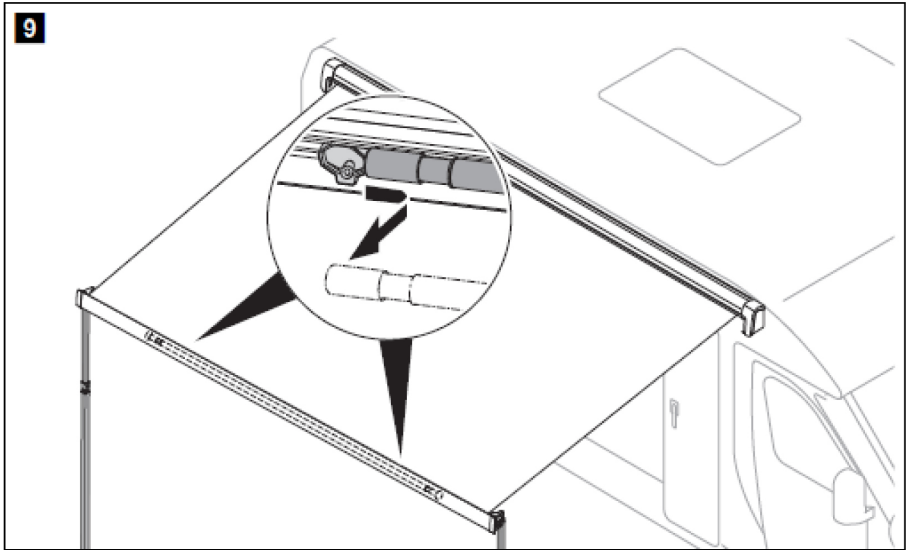

HOW TO USE YOUR MOTORHOME'S EQUIPMENT

Retracting the awning



NOTICE!

- Only retract the awning when the fabric is free of debris (branches, leaves or similar). Otherwise the awning may be damaged when it is retracted.
- Keep the awning free of dirt to prevent abrasions, stains and mildew.
- When retracting the awning, make sure that no branches or other objects are trapped in it.
- If the awning is retracted when wet, extend it again and the fabric dry out at the next opportunity. If the wet fabric stays rolled up for a long time, mildew will form and the fabric can fade.

➤ Proceed as shown (fig.11. to fig 15).

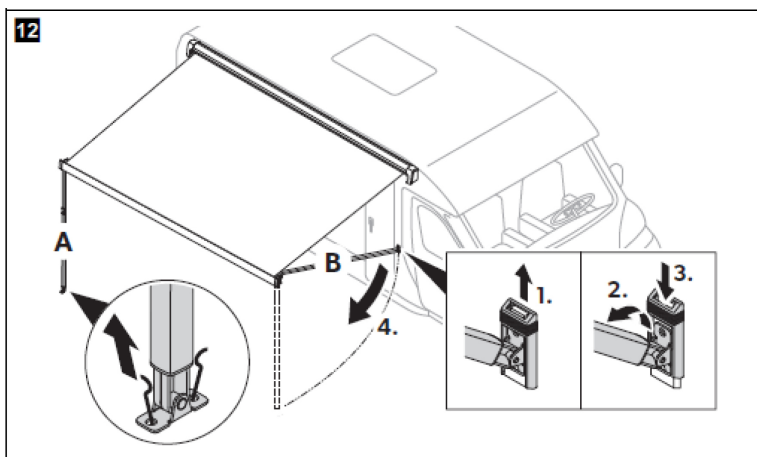
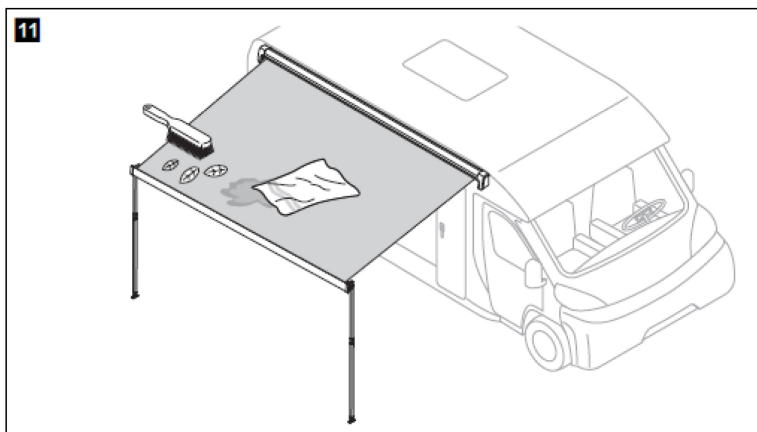

HOW TO USE YOUR MOTORHOME'S EQUIPMENT

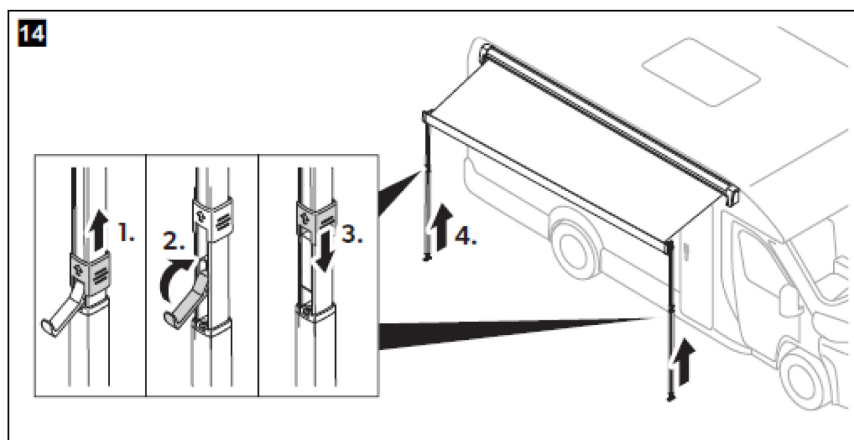
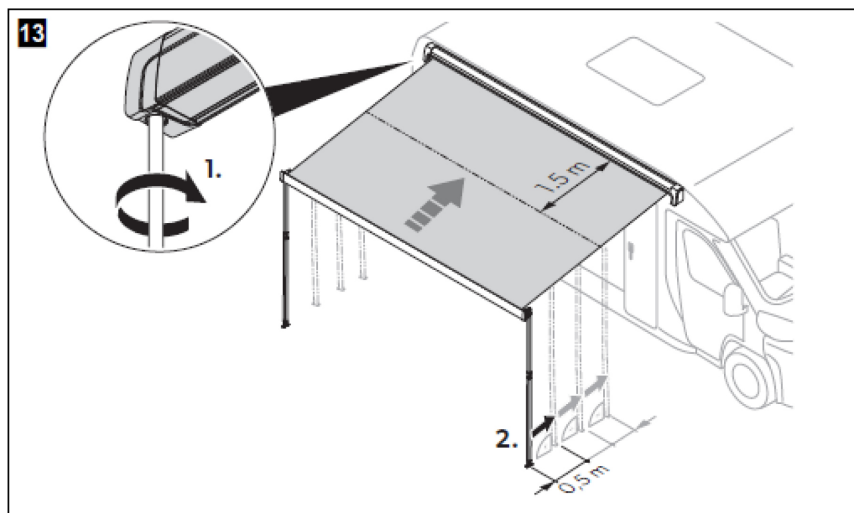

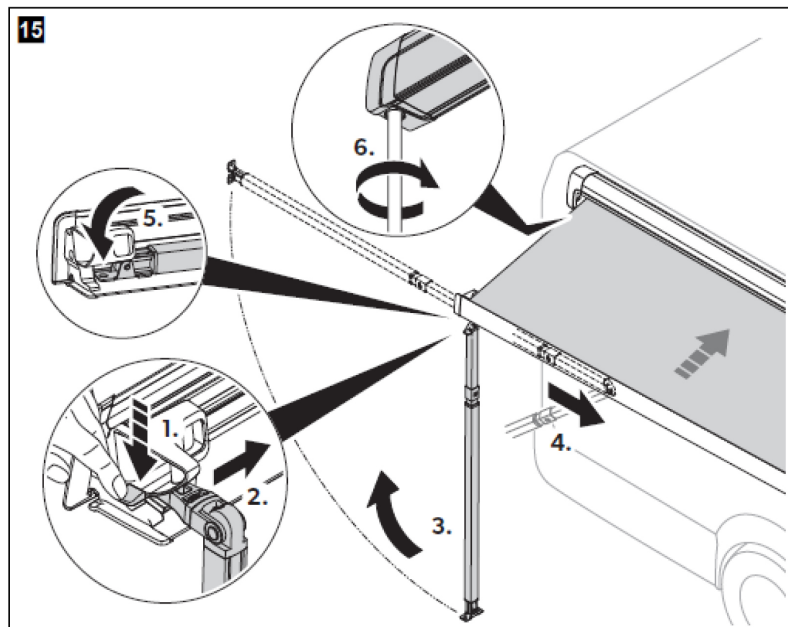

Cleaning and maintenance

Cleaning

NOTICE! Beware of damage

- **Never** clean the awning with a high-pressure cleaner.
- Do not use abrasive cleaning agents or hard objects during cleaning, as these can damage the product.

- Remove any debris (twigs, leaves or similar) lying on the awning fabric to prevent abrasions, stains and mildew. The awing can also be damaged when it is retracted.
- Clean the awning fabric regularly to remove any dirt and dust:
 - To do this, use water with 30ml detergent and 30ml bleach for 10L of water.
 - Soap down the fabric and leave the liquid to soak in for five minutes.
 - Rinse thoroughly with clean water.Make sure that the detergent with the bleach is completely washed off. Otherwise it can damage the fabric.
- Leave the fabric to dry.

NOTE

The manufacturer recommends:

To clean the cloth used the Dometic awning cleaner (ref. no 9600000165, available from your service partner).

Lubricating

- If required, lubricate the joints of the awning with paraffin wax, teflon oil or silicone oil.

Checking



WARNING!

Do not use the awning if any settings or maintenance work are required. If you discover any damage, please contact a service partner in the respective country .

1. Check the awning regularly for any imbalance and wear, as well as damage to major parts.
2. Check the awning regularly:
 - Is the fabric free from damage?
 - Are the arms and lead rail free of damage with no signs of wear?
 - Does the awning close properly?



NOTE

Dometic accessories such as sealing joints or foam strips are subject to environmental wear and tear. This is not an evidence of poor quality. To ensure the function of these parts, Dometic recommends replacing rubber seals and foam strips every 5 years.

HOW TO USE YOUR MOTORHOME'S EQUIPMENT

Tighten up the screws on the rear hinge

The screws on the rear hinge must be re-tightened after being subjected to a load for the first time:

- After the first holiday using the awning
- After driving 20000 km or six months after the awning was installed (whichever occurs first)

The screws on the rear hinge also need to be checked during the routine vehicle inspection.

Contact your service partner to re-tighten the screws (fig. 16).

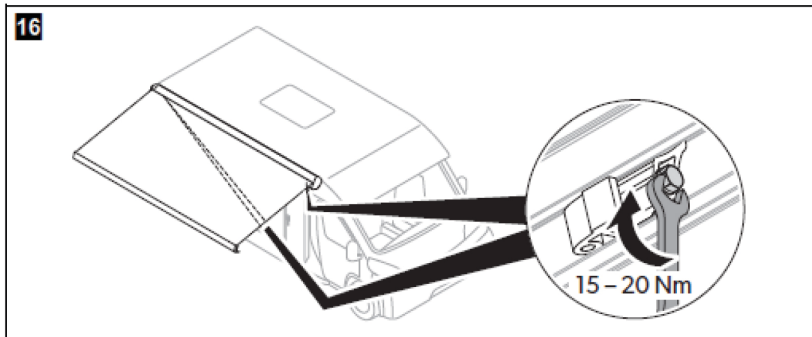

Tie down kit

Awnings, where specified, are supplied with a tie down kit. Please read the instructions and ensure the tie down kit is used even in calm weather. Where wind speeds increase to more than a light breeze it is advised to take down the awning fully.

HOW TO USE YOUR MOTORHOME'S EQUIPMENT

Tow Bar (Where fitted)

Maintenance

Periodic maintenance must be carried out and should include checking:-

- All fixing points and torque settings
- All Towbar components for any movement from original position and ensure it is rigid, square and secure.
- Chassis for corrosion around the Towbar mounting points
- Possible wear on Towball
- Towbar paintwork for chips, scratches etc.

Any use outside of the recommended towing limits for the vehicle or failure to carry out maintenance check will invalidate warranty.

Note:

1. Recommended Torque Setting for M12 Grade 10.9-130 Nm.
2. Nose load limits and vehicle manufacturers trailer / caravan weight limits must be observed.

HOW TO USE YOUR MOTORHOME'S EQUIPMENT

Avalon/Quantum Rear view system

MIRROR MONITOR QUICK START GUIDE



The HYMER Mirror Monitor features an integrated accident camera and a rearview/ reversing camera. All the normal user features can be accessed on the HI-resolution 9.66" IPS touch screen display panel.

To display the menu or display the camera images if in driving mode (see notes that follow) tap on the screen which will display the camera images, status icons and menu buttons.

These functions will be displayed for approx. 20 seconds after the screen has been tapped.



CHANGING DISPLAYED CAMERAS AND PICTURE POSITION



DRIVING MODE



Power Button

The button is quite small and is fitted centrally underneath the monitor. This button is not intended to be used regularly as all the normal functions have been designed to be accessed through the screen.

The Monitor can be turned ON or OFF by holding the button down for 3 seconds.

When power is removed the Monitor will turn off but will remember its state so when the vehicle is restarted the Monitor returns to the same state.

External connections to the Monitor



On top of the Monitor there is a slot for the TF card which the recorded footage is saved onto, and an option to connect a GPS Receiver. The USB and AV Input ports are not used on this Monitor as these connections are made through the vehicle harness.

The vehicle harness provides a connection for a reverse trigger which, when the vehicle is put into reverse, forces the monitor to display the reverse camera regardless of the Monitors status.

The Power and Camera connections are made through the vehicle harness.

SET UP MENU – RECORDING DISABLED

If Recording is Enabled the MENU options will change to the menus shown on the opposite page

Use the UP/ DOWN arrows to change menu pages, use the yellow return icon to exit menus

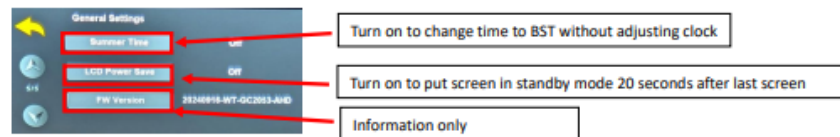
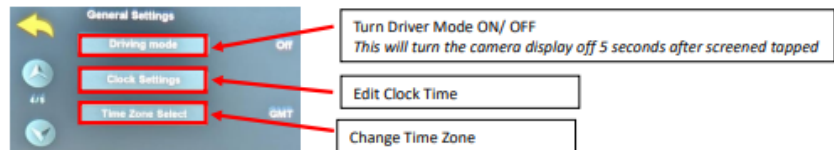
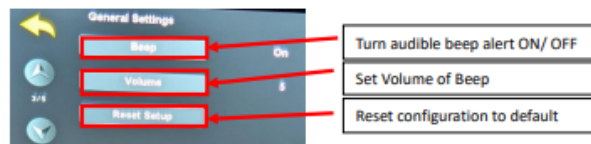
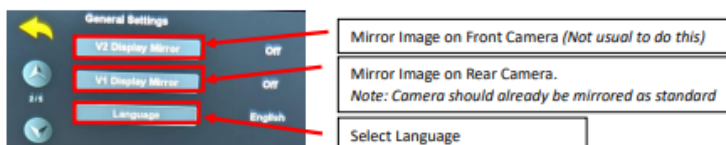
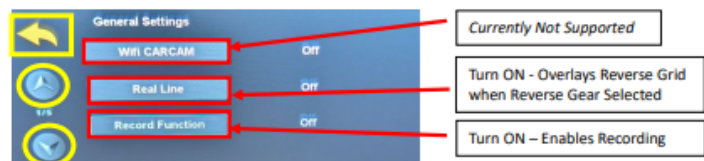

REVIEWING RECORDED VIDEOS

Recording must be turned off to enter Playback Menu

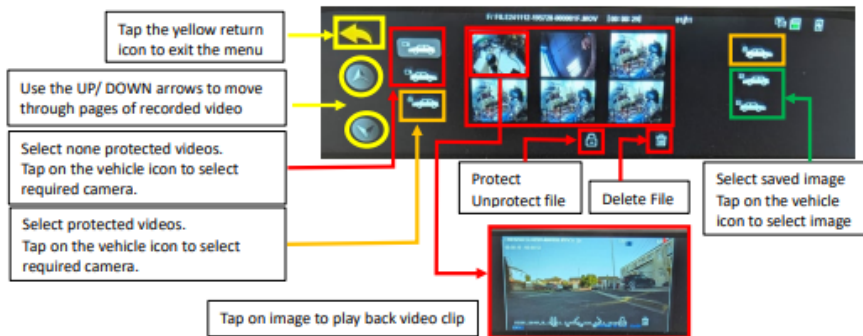

SET UP MENU – RECORDING ENABLED

Recording must be turned off – Tap Recording Icon to turn recording off

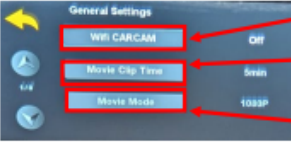

Currently Not Supported

Set length of each recording clip.
Longer Clip Time files are bigger, but more memory usage efficient

Set Recording Resolution.
The Higher Resolution the better quality, but uses more memory

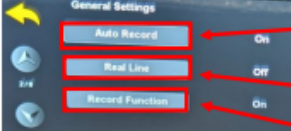

Turn Auto Record ON/ OFF
When Auto Record is turned on Video is continually recorded

Mirror Image on Rear Camera.
Note: Camera should already be mirrored as standard

Turn Recording ON/ OFF

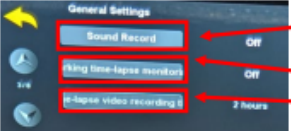

Turn Audio Recording ON/ OFF

Turn on time lapse recording when ignition off (select fps)

Set time lapse records for after ignition off (select time period)

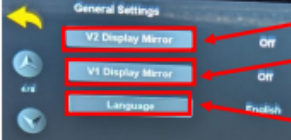

Mirror Image on Front Camera (Not usual to do this)

Mirror Image on Rear Camera.
Note: Camera should already be mirrored as standard

Select Language

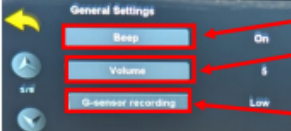

Turn audible beep alert ON/ OFF

Set Volume of Beep

Turn G Event Recording ON/ OFF, select Sensitivity
G Event Videos are protected and will not be overwritten

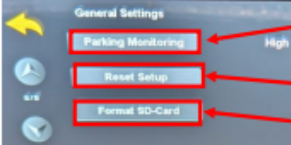

Turn Parking G Event Recording ON/ OFF, select Sensitivity
G Event Videos are protected and will not be overwritten

Reset configuration to default

Format Storage Medium

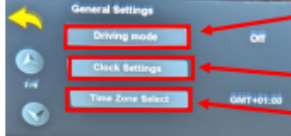

Turn Driver Mode ON/ OFF
This will turn the camera display off 5 seconds after screened tapped

Edit Clock Time

Change Time Zone

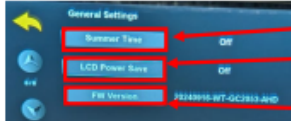

Turn on to change time to BST without adjusting clock

Turn on to put screen in standby mode 20 seconds after last screen

Information only

SECURITY

Theft deterrent, prevention and security of your motorhome is taken very seriously at Erwin Hymer Group UK. That is why we have provided a combination of standard features and optional extras designed to deter and prevent thieves from stealing your property. And in the unlikely event that they should succeed, aid the identification, speedy recovery of your property and assist in the prosecution of the thief.

Tracker (Option)

Your motorhome can be fitted with an optional TRACKER.

Your dealer may have registered the motorhome with TRACKER and confirmation sent to you via email.

If it has not been registered you can easily do it yourself.

Open the TRACKER registration portal
www.tracker.co.uk/elddis

TRACKER VLU and Motorhome VIN Numbers are matched and confirmed with the vehicle model

Enter Dealership name from dropdown menu

Enter customer details including email address

Confirmation sent to customer email

One year subscription will begin

TRACKER will contact customer towards the end of the one year subscription period with the options available.

or call TRACKER directly on 0870 606 1269

Motorhome Theft

The theft of a motorhome can occur in the most unlikely circumstances; from a motorway service area, even from an owner's driveway. Secure all windows and doors when your motorhome is unoccupied, even if only for a short length of time.

VIN CHIP

VIN CHIP is the theft deterrent and identification system for touring caravans and motorhomes. VIN CHIP has been launched to deter criminals looking to steal touring caravans and motorhomes and help aid the identification and recovery. VIN CHIP is unique as it uses both visible and invisible markings containing a specific 17 digit VIN.

Alarm (option)

Your motorhome can be fitted with an optional Autowatch 695 Thattham Category 2-1 alarm.

Electronic Alarm (Category 2-1)

A Thattham assessed 2-1 Electronic Alarm is to be combined on a vehicle installed with an existing Thattham Category 2 immobilisation system to obtain a Thattham Category 1 status.

Alarm

The Alarm is to provide warning of an attempted of intrusion into the passenger compartment or unauthorised interference with a vehicle.

- Perimeter detection
- Ignition detection
- Passenger compartment movement detection
- Audible warning with battery back-up power supply
- Siren Resistance to attack for a minimum duration of 1 minute

CARE OF YOUR MOTORHOME

This section of the guide is devoted to the care, cleaning and general preservation of your motorhome in order to retain its showroom condition.

All the adhesives used to seal exterior components are mould resistant but not mould proof. In order to ensure that these adhesive beads are maintained in the best possible condition and that their appearance does not become unduly affected by mould growth, it is recommended that they are regularly washed and cleaned using a suitable proprietary caravan or car cleaning wash product.

EXTERIOR CLEANING

Cleaning recommendations

Regular cleaning must be carried out to maintain the lifespan of the product. The outer surfaces should be cleaned by hand using cold water to remove any embedded dirt, then use suitable proprietary caravan or car cleaning products in accordance with the manufacturers recommendations.

All heavily soiled areas of grease or oil smeared surfaces should be washed or wiped off immediately. Drying can be done naturally or with a soft clean cloth.

General Cleaning

Do not use a pressure washer on your vehicle as it can lead to water entering via any of the external vents and could cause damage to the graphics. NO mechanical cleaning aids should be used i.e rotating brushes, scrapers or similar cleaning devices as they will scratch the outer surface of the product. Under NO circumstances should an abrasive or harsh cleaner be used. The use of tree resin remover should be avoided, cleaning agents of this type can lead to stress cracks in the product.

User Tip: In general, cleaning agents should be removed from the surface to avoid lasting damage.

Glass Fibre Reinforced Plastic (GRP)

GRP components need to be washed, waxed and taken care of like a car. Chemicals and dirt can collect during storage, and the gel coat can be stained or marked when chemicals combine with rain or dew. Most stains or marks can be

removed with Blue Diamond black streak remover, but more stubborn marks may require a (fine grit) rubbing compound such as Farcela G3. To help keep your GRP components looking almost like new, it is wise to wash the parts monthly (or more frequently) using suitable proprietary caravan or car cleaning products, but avoid using strong alkaline (e.g. trisodium phosphate) or acidic cleaners or abrasives. Waxing the components once or twice a year with a good grade paste wax will help to maintain the colour and finish.

Acrylic Windows

Your motorhome is fitted with shatter resistant acrylic windows. To preserve their clarity and unblemished transparency it is essential that the following cleaning instructions are strictly adhered to: Road grit, dust, sand, flies, bird droppings etc., should be washed off using plenty of cold water do not use a sponge to clean off heavy dirt deposits. Any remaining dirt should be washed off using a soft cloth and warm water. Under NO circumstances should any abrasive cleaning agents, household detergents or proprietary cleaning fluids be used. Wash the window again using only cold water and dry off with chamois leather.

Please note: Should scratches appear on the acrylic windows these can often be removed with an acrylic polish. Gentle polishing with a liquid metal polish, i.e. Brasso may also have the desired effect - consult your retailer BEFORE attempting to remove any but the slightest scratch.

Window Blinds & Flyscreens

To clean the blinds and flyscreens, moisten a soft cloth or sponge with a small amount of water and mild soap suds and gently wipe dirt off. Allow to dry before retracting, failure to do this could result in mildew forming.

ABS - Wheel Spats & Panels

To preserve the appearance of all ABS panels and fittings road grit, dust, sand, flies, bird droppings etc., should be washed off using plenty of cold water. Any remaining dirt should be washed off using a soft cloth and warm water. Under NO circumstances should any abrasive cleaning agents, household detergents or proprietary cleaning fluids be used. Wash the ABS material again using only cold water and dry off.

Interior Walls

Your motorhome interior walls will only require a wipe over with a damp cloth and soap and water to keep them in a 'showroom' condition.

Furniture

Treat your motorhome furniture as you would the furniture in your home. Polish wood surfaces sparingly with a good quality wax or spray polish. Use a damp cloth to clean Melanate laminated surfaces.

Taking care of your upholstery:

You may find your upholstery a little firm at first, this is perfectly normal as all foam and filling composites will naturally soften in time. This softening does not constitute as a fault under the warranty. Fabrics with a pile may appear to have a difference in shades, this is due to the direction of the pile and how the light reflects. This is not a fault but a part of the charm of the fabrics. Regular care with a soft brush will ease the pile back and reduce the effect of the pile being flattened over time. Fabric will stretch, move and develop creases or wrinkles during use, these are expected and are completely normal during the lifetime of the product. It is important that all cushions and upholstery are regularly "dressed". To do this, the cushions and upholstery require 'plumping' to ensure they revert to their original shape. Without "dressing" and "smoothing" the cushions it could give the appearance of flat or miss shaped, making the fabric appear loose or baggy. This is not a defect but part of the care of the product/s. Please ensure all cushions/upholstery are always placed in the correct position during use. It is recommended that the curtains in your leisure vehicle are washed on a delicate cycle at 30°C. This will not damage the clip glides. Shrinkage may be caused should you decide to dry clean your curtains.

Note: Curtains should not be left closed during daytime hours otherwise some fading may occur.

Taking care of your carpets: (Where fitted)

Soiling (dirt, dust and abrasive matter) is the greatest threat to carpet. Door mats should be cleaned frequently to prevent them from becoming a source of soiling. The best way to increase the life of your carpet is to vacuum regularly. For general cleaning use a dry shampoo following the products instructions. Spills are likely to happen and if you treat spots and stains immediately, they will be easier to remove. Blot liquids with a dry, white, absorbent cloth or plain white paper towel. To prevent the spill from spreading, please work from the edge of the spot to the centre. For food and other non- liquids, start by gently scraping up with a spoon or knife blade and vacuum until completely removed.

Note: Do not get the carpet too wet. Wetting through to the backing may result in shrinkage, discoloration, odour and delaminating. Certain products can cause irreparable damage to your carpet. Bleaches, tile cleaners, mildew removers, oven cleaners, etc can have strong chemicals which discolour or dissolve carpet fibres.

Washroom And Handbasin Fittings

These should be cleaned using a non abrasive household cleaner. Always put the cold water into the hand basin before adding the hot in order to preserve the finish of the thermoplastic formed basin.

Cleaning instructions for all chrome & black plated products – (taps, wastes, bathroom accessories, etc.)

Alcohol, solvents and solid detergents, liquids containing acid or aggressive solutions, anti- calcareous products, abrasive sponges or steel wool should absolutely be avoided since they could corrode in an irreparable way the outer surface of the products.

Please note: Under no circumstances should alcohol, spirit or solvent-based liquids be used on GRP or ABS plastic panels as these substances may react with the material and cause visible damage.

Shower Trays

Only clean your shower tray using soap and water. Do not use chemical based cleaning agents as this may attack the material of the tray.

Water Systems

The water systems and in particular storage tanks, in motorhomes are susceptible to contamination by bacteria if care is not taken with their use and cleaning. The symptoms caused by bacterial contamination are not purely limited to gastro-intestinal diseases, but may also manifest themselves as ear, nose, throat, and eye or skin infections. It is therefore important that you carry out the following procedure prior to using the motorhome each time, even if you boil or filter all water you use for drinking.

Please note: If your motorhome is not going to be used for an extended period of time please refer to section 11-1 Storage.

Water Containers

- (i) All water remaining in any water container should be disposed of so that the container is empty.
- (ii) The outside of external water containers should be thoroughly cleansed and washed down to remove any dirt, dust or other contaminant. Water at a suitably hot temperature containing an appropriate detergent is recommended for this purpose. Water should then be put into the container, swirled round and then emptied out.
- (iii) All containers should then be totally filled with water containing an appropriate disinfectant / sterilising solution and allowed to stand for the appropriate contact time.
- (iv) The solution should be emptied from the container.
- (v) External containers should be inverted whilst stored overnight (if possible).
- (vi) Containers must be filled with mains water only and mains water only should be used for the above cleaning procedure.
- (vii) On no account should garden hoses be used to fill water tanks.

Internal Water Systems

- (i) Drain down the system. (Open all taps to allow air in, enabling the system to drain quickly).
- (ii) Fill the system by using the pump with a disinfectant / sterilising solution. (Check that the solution at full strength appears at all taps/showers). Allow to stand for the recommended period of time.
- (iii) Drain the system down completely.
- (iv) Thoroughly clean the outside of all taps/connectors with a cloth soaked in the disinfectant / sterilising solution.
- (v) Flush the system through with clean drinking water until no traces of disinfectant / sterilising solution can be detected at any tap.
- (vi) Suitable sterilising chemicals are available from your Erwin Hymer Group UK Retailer. It is not, however, recommended to use bleach or sodium Metabisulphite.

Theftford Toilet

WARNINGS

Cold Weather Use - To prevent freezing during cold weather use, add antifreeze to the toilet system fresh water tank. Use a non-toxic (propylene glycol) type of antifreeze. Refer to chart on container to obtain level of protection.

Warmer Weather Use - In warmer weather or longer intervals between emptying the waste tank you may require additional toilet fluid. Use only Theftford toilet fluid to achieve the best results.

CAUTIONS

- Never add toilet fluid directly into toilet bowl.
- Do not use strong household detergents or cleaners that contain chlorine, solvents or acid contents.
- High Altitude and Hot Weather Use - with large temperature differences and changing heights during driving, pressure can start to build up in the waste holding tank, causing contents to splash upward upon opening the valve blade if opened too fast.

Changing a Wheel

Refer to the original manufacturer handbook provided.

Tyres & Tyre Pressures

Please refer to the Technical Specifications pack that is provided with the vehicle for information regarding tyre pressures and tyre sizes. It is dangerous to drive with under inflated tyres. Pressure checks, including those on the spare tyre, should be carried out whilst the tyres are cold using an accurate pressure gauge. These checks should be carried out before each journey and at regular intervals during storage.

Tyre Wear and Damage

Your vehicle tyres, like all tyres, are legally required to have a minimum tread depth. Please refer to the original manufacturer's handbook provided. A redundant tyre must be replaced by one of the same size and load index. A tyre should be renewed if a blister, rupture or cut exposing the casing is detected. If the tyre has suffered a violent impact, it should be examined by a specialist as soon as possible.

PRE-SEASON WATER SYSTEM PREPARATION (WHIRLWIND/AUTOQUEST APEX)

Over the winter months bacteria can grow in your water system. Particles of minerals and dirt gather in joins and any undrained areas.

After following this guide, change your water filter. If you have a Whale AquaSmart system, change your Whale WF3000 Water Filter. If you have an in line filter in your plumbing system, Whale recommend you use WF1230 Aquasource Water Filter.

To check the system hasn't suffered any frost damage over the winter and floods your van, take the following precautions:

- Close all drain valves in your van's water system.
- Re-attach your shower head.
- Ensure all taps and showers are positioned over sinks and drains.
- Check condition of leisure battery, if it is below 12V please connect to mains electricity supply.
- Rinse out fresh and waste water tanks with water, add a non-caustic cleaning and purifying agent.
- Completely fill your fresh water tank with tap water.
- Leave the hot tap that is furthest away from the water heater fully open, close all remaining taps and showers.
- Turn on isolation switch for water pump, normally found on the control panel or in a menu within the control panel's software.
- You should hear the pump running or the pressure coming from the open hot tap.
- Water will pop and splash as it comes from the hot tap, it will take some time for a flow of water to arrive as the water heater needs to fill up first.
- Once an even flow is achieved, work back towards the water heater, opening the next further away hot tap until all have been opened and there is a smooth water flow.
- The next stage is to close all hot water taps and open the cold water taps in the same order as the hot taps, beginning at the furthest away cold tap.
- When an even flow is achieved through all the taps in your van close all the taps. The pump should turn off (after a few seconds if it is a pressurised system).

Remain in your van after the pump has stopped and inspect all the taps and shower heads for leaks. You may need to dry them down first to spot any leaks). If there is access to the underside of the taps check for water leaks.

If you find a water leak, check the following:

- If there is a water leak coming from the connections on the underside of the tap, try to push them home.
- If the leak originates from a crack or an unknown source check the rest of the taps and showers before turning off the water pump.
- Then drain the water system as the water pressure will continue to escape through the leak and will cause water damage to your van. Contact your local dealer to rectify the leak(s).

(Note: While checking the taps and showers you may hear the pump turn on and off a few times. If you hear this, turn on and off all the taps for 10 seconds individually to remove any trapped air from the system.)

- If the pump continues to run intermittently for short bursts this can indicate a leak as pressure is being lost. Follow all the water pipes and check if there is any water leaking from joints or if a pipe is burst.
- Should you find a leak at a joint, tighten the joint or push the pipe fully into the Quicklift fitting to dry up the water and wait to see if the problem persists.
- If you find a burst pipe or damaged tap/shower we recommend that you contact your nearest Motorhome dealer.
- After the cleaning agent has remained in the system for the required time, purge the system by running 2 or 3 full tanks of water through the system using all taps and showers in the mixed position.
- Check the strainer on the pump.
- Finally your system is ready for use.

If you have successfully carried out this guide, please check your water heater is functioning correctly, to do this please follow the manufacturer's instructions.

Enjoy the new season.

GETTING READY FOR THE WINTER (WHIRLWIND/AUTOQUEST APEX)

If possible carry out the following procedure prior to moving your vehicle to its winter storage location. The movement of the vehicle will encourage residual water to naturally drain from the system.

Ensuring that all water is removed from the vehicle's pipework, taps and appliances will reduce the risk of frost damage occurring. Frost damage occurs when water left in the system freezes and expands, causing pipework and appliances to split, crack or burst.

- Open water heater drain valve and leave open.
- Open external tank valve (if present) and leave open.
- Ideally, position motorhome so the drain taps are at the lowest point i.e. tilt the motorhome or park on a slope.
- Ensure the gas is turned off at the mains.
- Open all taps/mixers to the mid position, including the external shower (if fitted).
- If internal pump is accessible, disconnect outlet pipe and turn on pump, allow to run for 2 minutes to expel additional water into an adequate basin, turn the pump off. Only reconnect pump when water system is to be used.
- Remove shower head and hose (including the external shower, if fitted) and shake water out.
- Waste tank - remove all sink plugs, open drain taps and leave open.
- Open any other drain points (if present).
- Drain all external water components.
- Fully drain/empty holding tank and flush toilet tank in accordance with the manufacturer's instructions.
- Do not close the fridge door, leave ajar to allow air flow to prevent mildew.

User tip: If mains electric hook up is available and a Whale Space Heater is fitted, select 500w electric and set temperature to frost protection.

User tip: To maintain the battery, periodically charge throughout the winter. Do not allow the leisure battery to fully discharge as this could cause irreversible damage.

WINTERISING THE ALDE WATER SYSTEM (AVALON/QUANTUM)

Winterizing the Alde water system is a simple but very important task and should be carried out when the vehicle is not being used and there is a possibility of freezing conditions. Any water left in the water system could freeze and cause a lot of expensive damage. Read this article which tells you how to winterize the water system in your Alde.

So, how do you winterize the Alde water system?

Start by switching off the freshwater pump and the Alde heating system. Open all the water taps (including the shower). Set the taps at the mid-point position between hot and cold as that allows both the hot and cold water systems to drain simultaneously. Also place the shower head in the shower tray so that no water is retained in the shower head feed pipe.

Open the yellow drain valve(s) by moving the lever to the vertical position. These are usually placed near to the Alde boiler. Some motorhomes have two drain valves, one for the hot water and one for the cold, so check your vehicle. Many only have one.

With the drain valves open, check that water is draining out underneath the vehicle.

Leave the taps and drain valves in the open position until the next time that the water system is used.

Finally, ensure that any LPG supply is turned off. If you wash the vehicle over the winter period, make sure that no water gets into the Alde gas flue, because once again this could freeze and cause damage.

And that's it. Your vehicle is now winterized.

Please note : Where 'wet' heating systems are fitted, please refer to the manufacturer's instructions for winterising. These winterising tips are intended as a general guide only. For servicing and product advice for your specific vehicle, please contact:

Whale Customer Support:

Tel: +44 (0)28 9127 0531

Fax: +44 (0)28 9146 6421

Email: info@whalepumps.com www.whalepumps.com

General

Information in this handbook relating to inspection and maintenance is referenced from Liquid Gas UK, Code of Practice 32 – 2020.

The maintenance of an installation after commissioning is the duty of a suitably trained and qualified person.

Periodic Inspection and Maintenance of the LPG system and appliances

- Periodic inspection and maintenance, including safety devices, shall be undertaken to ensure the continued safety and performance of the installation.
- Any redundant pipework shall be made safe, and where practicable disconnected and removed. Any redundant pipework that has not been removed shall be isolated, and any open end sealed with an appropriate fitting.
- Flexible pipework connections, including assemblies, should be routinely inspected, and replaced as needed (it is recommended that hoses are changed at or before they are 10 years old). These connections should not be used if any signs of physical damage, environmental degradation, or service failure are detected during inspection. The inspection process should cover:
 - o Physical damage: This includes cuts, abrasion, cracking, stretching, flattening, kinking, missing or worn sealing washers, damaged cylinder connections, and rodent attacks.
 - o Environmental deterioration: Look for stiffening, cracking, delamination of the outer covering, and chemical degradation, such as softening of the outer coating due to contact with oil.
 - o Service failure: Be alert for blistering, soft spots, rupture, and issues with preassembled end fittings, such as corrosion or loosening of swaged fittings that connect the hose.

Note - Any identified defects must be repaired by a suitably trained and qualified person.

It is a statutory requirement in Great Britain, the Isle of Man, Northern Ireland and Guernsey that all "gas work" (on installations within the scope of the Gas Safety (Installation and Use) Regulations) must be carried out by a business or self-employed person(s) that is a member of a "class of persons" registered with a registration body which has been approved by an approval body to operate and maintain such a register.

STORAGE

LONG TERM & WINTER STORAGE

If your motorhome is to be stored for any length of time, especially over the winter period, the following operations are recommended:

- (i) Ensure all windows, roof lights, habitation and exterior locker doors are closed firmly and locked.
- (ii) Remove all soft furnishings which could be affected by damp conditions
- (iii) Clean the motorhome inside and out.
- (iv) Drain the water system.
- (v) For winter storage and to prevent frost damage all taps must be left in the open position. For those motorhomes with lever taps please ensure the taps are left in the central position.
- (vi) All blinds and flyscreens should be left in the retracted position. Check all fixed ventilation apertures are not obstructed.
- (vii) Ensure that the refrigerator/freezer compartment doors are left open during storage.
- (viii) Check that the site you have chosen to store the motorhome is open, fairly high and dry and if possible not exposed to gales etc.
- (ix) It is recommended that you use a suitable dehumidifier or place a bowl of salt within your motorhome to absorb any moisture during the winter months.

Motorhome Covers

Covers may be used to protect your new Erwin Hymer Group UK motorhome provided that the cover used is of a breathable type.

Lower the TV antenna and ensure the cover is well tied down to avoid the cover being punctured.

Your motorhome must be ventilated every 4 to 6 weeks if it is to be stored with a cover in place.

Battery Maintenance

Storage

Ensure that the leisure battery is fully charged before placing the vehicle into storage.

Check the battery state every month, if the terminal voltage drops below 12.07V then re-charging is necessary.

Charging should be carried out in a cool, dry well ventilated area.

Do not place the battery onto cold surfaces such as concrete as this will affect the battery's ability to charge.

Should the motorhome be stored for a prolonged period of time it is strongly recommended that the motorhome is fully serviced before the commencement of use. Your retailer will ensure that your motorhome is safe, secure and ready for your enjoyment.

MOTORHOME HABITATION WARRANTY COVER

Introduction

At Erwin Hymer Group UK we are confident that our new motorhomes are engineered using the latest manufacturing techniques and advanced materials technology ensuring that, when buying one of our products, you are buying the very best. We extend this philosophy to our customers by offering long term peace of mind and reassurance through our extensive warranty cover.

Your warranty cover commences on the day your new motorhome is purchased and comprises of three key elements:

1. The base vehicle warranty cover is provided by the original manufacturer. Please contact your local base vehicle retailer direct for any base vehicle warranty issues.
2. Three year Erwin Hymer Group UK manufacturer's warranty
3. Ten year Erwin Hymer Group UK body integrity warranty

Scope

This applies to all new products and is a guide intended to give a brief overview of the warranty terms applicable to your vehicle.

Conditions of use

Your new motorhome has been designed as a leisure vehicle only. The warranty will not be given if the vehicle is used under the following circumstances.

- Used as a permanent residence
- Used for racing or time trials
- Damage resulting from freezing, accident or fire damage

Exclusions

- No liability will be accepted for fair wear and tear, including mould or discolouration of adhesive. Damage including rodent damage, wilful damage or negligence from abnormal working conditions will not be covered.
- Condensation is not covered under the warranty agreement.

Three year manufacturer's warranty

Year 1 warranty - Covers all original components, forming part of the original product specification excluding normal wear and tear.

Year 2 and 3 warranty – Covers all original components, forming part of the original product specification, excluding the following items:

- Normal wear and tear
- Microwaves
- Batteries
- Windows and glass
- All soft furnishings including mattresses (2-year warranty cover)
- Entertainment equipment
- LED lights
- All panels and plastic products
- Adjustments
- Ironmongery and corrosion of metallic components
- Electrical connections
- Floor coverings

We would recommend that customers have their vehicle serviced on or before the due date to ensure that all warrantable parts are identified before the expiry of the component.

Ten year body integrity warranty

Erwin Hymer Group UK products are covered against water ingress for 10 years from the original date of purchase of a new product. (Reduced to 6 years for subsequent owners from 1st owners original date of purchase). Covering any water ingress as a result of a warrantable defect through a permanently sealed seam or joint.

Reporting a fault

In the unlikely event that you experience a problem with your motorhome please contact your retailer.

It is with the retailer that your contract of sale exists and consequently they have the responsibility to ensure any complaints and warranty issues are addressed. Any Erwin Hymer Group UK approved Retailer / Service Centre are able to undertake any warrantable work at their convenience or discretion, but are not obliged to do so, if the vehicle was not purchased from them.

All Erwin Hymer Group UK products are classed as portable and therefore all work under warranty requires the motorhome to be delivered and collected from the approved chosen Erwin Hymer Group UK agent.

The cost of transporting the motorhome by any means to and from the place of repair is the responsibility of the owner.

In order to comply with the terms of the above cover the following conditions must be met.

Conditions attached to the warranty cover

- You must retain the original sales invoice for the motorhome.
- All new motorhomes must be registered with Erwin Hymer Group UK within 6 weeks of purchase. Your retailer can forward this information to us. Please keep us informed of any name or address changes by using the Notification of Change to Name and Address form.
- The motorhome must have an annual service and damp check carried out by an Erwin Hymer Group UK approved Retailer / Service Centre or NCC Approved workshop or NCC equivalent standard as set out in this handbook. Original invoices, service checklists and damp reports must be retained as proof that the annual services have been carried out in accordance with our warranty terms.

Service intervals:

- a) In years 1, 2, and 4 through to 9 the service must be completed no more than 60 days either side of the anniversary of the date of purchase.
- b) In Years 3 and 10 the service must be completed no more than 60 days on or before the anniversary of the date of purchase and must not exceed this date.
- c) For second owners the service in years 3 and 6 must be completed no more than 60 days on or before the anniversary of the original date of purchase. This date must not be exceeded.
- d) No service interval should exceed 14 months.
- e) **Failure to service the vehicle within the specified time limits will invalidate your warranty.**

We would recommend that you have your service carried out by an Erwin Hymer Group UK Approved Retailer/Service Centre, who are able to assist you should warranty work be required. Should you choose to have your service carried out by a non Erwin Hymer Group UK Approved agent, an additional charge may be payable by the customer to cover the second inspection.

- The motorhome must be made available for repair within 6 weeks of the date of inspection for the purpose of carrying out the repair work.
- Erwin Hymer Group UK reserves the right to inspect the vehicle before work commences. Failure to do this may invalidate your claim.
- All defects must be assessed by an Erwin Hymer Group UK Approved Service Centre to determine the root cause of the issue. They must submit a warranty claim for our consideration, to determine if the defect is covered by the manufacturer's warranty agreement. The repair method will be agreed and any rework will be carried out at no charge to the customer.

We will not be responsible for cost incurred without prior approval via the warranty authorisation process.

Warranty work may only be undertaken by an Erwin Hymer Group UK Approved Retailer/Service Centre.

- Erwin Hymer Group UK will pay the costs of remedial work to the repairer, only after approved work has been carried out. The cost of transporting, towing or moving the motorhome by any means to or from the place of repair is the responsibility of the owner.
- The Policy is not retrospective and is applicable to 2012 model year motorhomes onwards.
- No liability will be accepted for any consequential loss, damage, costs, expenses or other claims for compensation arising which were not reasonably foreseeable by both parties when the motorhome was originally purchased.
- No alteration may be made to the original construction.

Mains electrics

It is recommended that you have your mains electrics system inspected by a NICEIC approved contractor every 3 years.

Transfer of ownership

If you purchase this vehicle as a used vehicle it may be possible to transfer the unexpired term of the warranty cover (up to a maximum of six years commencing at the original date of purchase from new). The warranty cover for a used vehicle commences from the original date of purchase from new and is as follows:

- Three Year Manufacturer's Warranty
- A maximum of Six Years' Water Ingress and Body Integrity Warranty

The warranty is subject to the usual terms and conditions set out in the handbook and is only transferable on payment of an administration fee. Full documentary evidence that the motorhome has been serviced annually should be provided at the time of transfer, in accordance with the terms and conditions of the warranty stated in the handbook. Transfer of ownership must be completed within three months of change of legal ownership. Please complete the Notification of Change of Ownership form in your handbook. Failure to do this will negate the remaining warranty.

This warranty does not affect the purchaser's statutory rights. The warranty shall be governed and construed in accordance with the laws of England and the parties irrevocably submit to the exclusive jurisdiction of the courts of England.

For second owners the service in years 3 and 6 must be completed on or up to 60 days before the anniversary of the first owners date of purchase and must not exceed this date.

NON WARRANTY REPAIRS

Should you require any replacement parts for your motorhome it is necessary that you contact the Retailer from whom you purchased the motorhome or any Erwin Hymer Group UK approved Service Centre and give the following information, which will help in identifying the required component:

- (i) Model and make of motorhome
- (ii) VIN number
- (iii) Description of required part
- (iv) Photograph, size or diagram of required part

Please note: All parts must be ordered and supplied through an approved Retailer or Service Centre.

REMEDIAL WORK

Erwin Hymer Group UK, together with its suppliers is continually undertaking extensive research into testing, remedial work procedures and materials such as structural bonding adhesives, gaskets and tapes.

Therefore, if for any reason your new motorhome is damaged or requires remedial work then we would recommend an approved Erwin Hymer Group UK Retailer or Service Centre should undertake such work.

All such work must be undertaken using only approved Erwin Hymer Group UK genuine parts, recommended structural bonding adhesive and following Erwin Hymer Group UK procedures. Erwin Hymer Group UK will also undertake to supply certain specialist repairers with the necessary spare parts. In this case, your selected repairer must contact the PARTS DEPARTMENT with all enquiries.

Base vehicle warranty - The base vehicle warranty cover is provided by the original manufacture. Please contact your local base vehicle retailer direct for any base vehicle warranty issues.

MOTORHOME CONSTRUCTION - MAIN COMPONENTS

The following is a brief description of the main components used in your motorhome. More comprehensive descriptions can be found in the equipment manufacturers literature held in the Owner's Information Pack.

SOLID CONSTRUCTION BODY SHELL

Erwin Hymer Group UK Motorhome Bodies are constructed from the highest quality materials. The fully insulated floor is a constructed timber frame with plywood internal floor and a GRP underskin for added water resistance and insulation laminated together for strength. The walls & roof comprise an insulated foam sandwich having pre-coated aluminium exterior surfaces or GRP and vinyl coated internal finish. Wooden framing is positioned within the sandwich to add strength. The latest technology is used to produce the extremely well insulated and robust, yet lightweight sections.

WINDOWS

Windows are all of a double glazed acrylic construction and the door frames are extruded aluminium.

INSULATION

Erwin Hymer Group UK motorhomes are built to comply with grade 3 thermal insulation in accordance with the European Standard BSEN 1645 part 1. This states that an average temperature difference of at least 35°C between the inside and outside temperatures should be achieved when the outside temperature is -15°C and an internal temperature of 20°C.

ELECTRICAL DRAWINGS

WHIRLWIND/AUTOQUEST APEX

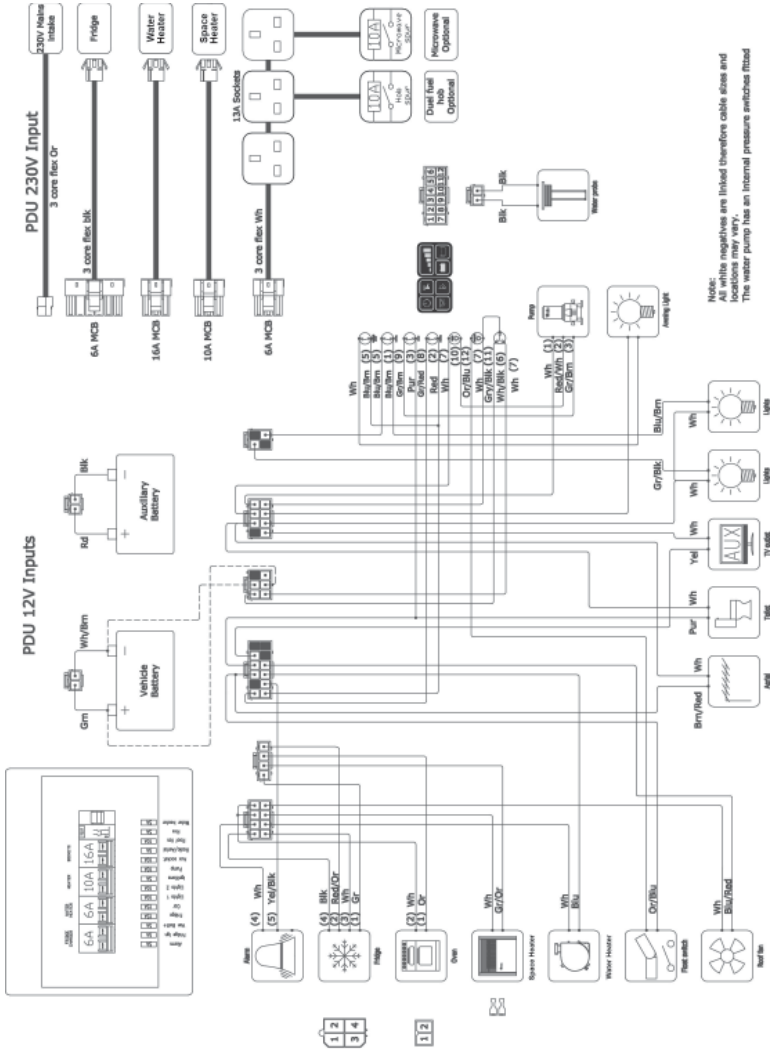

Colour Key

- Wh - White
- Yc - Yellow
- Or - Orange
- Red - Red
- Gr - Green
- Bl - Blue
- Br - Brown
- Bk - Black
- Pnk - Pink
- Pk/Bl - Pink/Blue
- Br/Bl - Brown/Blue
- Br/Wh - Brown/White
- Wh/Bl - White/Blue
- Wh/Br - White/Brown
- Wh/Bk - White/Black
- Red/Or - Red/Orange
- Or/Wh - Orange/White
- Gr/Bl - Green/Blue
- Gr/Br - Green/Brown
- Bl/Red - Blue/Red
- Bl/Br - Blue/Brown
- Gr/Bk - Green/Black
- Wh/Bl - White/Blue
- Wh/Br - White/Brown
- Gr/Br - Green/Brown
- Red/Wh - Red/White
- Gr/Bk - Grey/Black

Note:
White negatives are linked therefore cable sizes and locations may vary.
The water pump has an internal pressure switches fitted

GENERAL QUESTIONS

Q: Where Can I Obtain Your Latest Brochure?

A: Our latest brochures are available from Approved Retailers or can be viewed and printed from our website
www.elddis.co.uk
www.buccaneer-rv.co.uk
www.xplore-rv.co.uk

Q: Why Is the Handbook Not Specific To My Model?

A: Many of the components used in the manufacture of our motorhomes are identical throughout our model ranges, so we produce a generic handbook, which covers all models manufactured within a range for that season. If the literature supplied with your motorhome does not answer your question then please contact your Retailer for further assistance.

Q. I Require Technical Or Other Information, Who Can Help Me?

A. The majority of information you require is available through your Erwin Hymer Group UK Retailer.

Q - Can You Tell Me The Second Hand Price Of My Motorhome?

A - As a manufacturer we are not involved in the second hand market. You should contact a Retailer. They should be able to give some indication of market value.

Q: Can I Fit A Bicycle Rack/Top Box/Air Conditioning To My motorhome?

A: It may be possible to fit accessories to your motorhome but this will depend upon the internal construction of the roof/walls and whether they can support the weight of the accessory. If it is possible your Retailer will be able to advise you, (or alternatively they will obtain confirmation and a drawing where necessary, from Erwin Hymer Group UK). Please note that weight of any accessories will reduce your User Payload allowance. **Q: My Interior Lights Are Not Working, What Do I Do?**

A: It is possible that all of the 230V mains electrical equipment may not be operated simultaneously. Check fuses, battery connections and power supply (master light switch). Refer to your Retailer for further assistance.

PLEASE NOTE: The internal lights in your motorhome will not operate whilst the motorhome engine is running.

Q: Where Can I Get Spare Parts For My Motorhome?

A: We do not supply parts direct, we have an extensive network of Retailers/Service Centres which will be able to source most parts you require. For details of your nearest Erwin Hymer Group UK Retailer please refer to 'Find A Retailer' section on our website. Note: If your vehicle is 8 years or older please refer to the Help and Support/FAQ's/Parts section of our website <https://elddis.co.uk/help-and-support/faqs>, for a list of surplus stocklists and breakers.

Q. How Many Years Will Spare Parts Be Available For My Motorhome?

A. Erwin Hymer Group UK will endeavour to supply spare parts for a motorhome, for at least 8 years from new.

Q. Why Don't You Stock Parts At The Erwin Hymer Group UK Factory?

A. Due to the volume of models we produce it is not possible for us to maintain stock levels of every individual component used in our manufacturing process. We do stock commonly requested items, but some items must be made to order

Q. What If The Parts Are No Longer Available?

A. Where an original part is no longer available, whenever possible we will suggest a suitable alternative if it is available.

Q: Who Can Service My Motorhome Habitation?

A: Any EHG UK Ltd Approved / Service Centre can undertake the service work, but this is at their discretion. We will also accept services completed by a NCC approved company, but they will NOT be able to undertake any warranty work if they are not an EHG UK Ltd Approved / Service Centre.

You may choose to have your annual service performed by an unauthorized repairer / service Centre and if you do it will be your responsibility to ensure that the service meets our requirements.

Q. I Am Having Trouble Booking My Motorhome in For Its Service, In Line With The Requirements. What Timescale Is Acceptable?

A. Please refer to the warranty section for the terms and conditions of servicing. We would recommend that you plan your services in advance in order to meet the requirements.

Q. I Have A Problem With My motorhome, Who Can Help Me?

A. We would always recommend that you contact your supplying Retailer. Your local Erwin Hymer Group UK approved workshop or NCC equivalent standard as set out in this handbook may be able to assist. An inspection can then take place and the necessary course of action agreed.

Q. I Am Unhappy With The Service I Have Received From My Retailer/Service Centre, Where Do I Go From Here?

A. We would recommend that you write to your Retailer/Service Centre, detailing your problems and requirements, requesting a response explaining how they will resolve your complaint. A copy of your letter can also be forwarded to Erwin Hymer Group UK Customer Care Department, quoting the serial number of your motorhome and the name of the Retailer/Service Centre. Please be assured that we will assist your Retailer/ Service Centre in resolving any problems.

Q. Where can I obtain a Certificate of Conformity for my product?

A. Original certificate of conformity are supplied with the product, duplicates are chargeable and can be requested from our customer care team. We endeavour to provide a duplicate certificate of conformity for any product manufactured from the year 2000 onwards.

If you have a product manufactured prior to the year 2000, we are no longer able to supply a duplicate certificate of conformity. Additionally, due to the age of your vehicle we are unable to account for any modifications made following the initial purchase. If you are looking to export the vehicle, we recommend the vehicle is taken for an individual vehicle approval (IVA) or similar in the country of intended registration.

GLOSSARY

ABS Plastic

Acrylonitrile Butadiene Styrene Plastic the material used for most of the large plastic components within your vehicle.

Actual Laden Weight

This is the total weight of the vehicle when ready for use by the end user.

Awning

This is a tent-like structure of fabric over a supporting framework, which can be attached to the side of vehicle.

Battery Charger

This is required to keep a leisure battery charged. All vehicles include a charging facility which operates via the mains hook-up, and also has the ability to recharge through the base vehicle chassis or tow car's alternator.

Berth(s)

Sleeping place - Refers to the number of people a vehicle can accommodate for sleeping.

Blown Air Heating

A method of heating the living quarters of a vehicle by use of a fan pushing air out through a number of outlets.

Bunk Bed

This is a sleeping place, usually higher up than a conventional bed. Often (but not always) this can be folded or removed to provide additional living space.

Butane

Is a form of Liquefied Petroleum Gas (LPG) which normally comes in blue cylinders. This type of gas is most commonly used in the UK, although a switch to propane is advised in severely cold weather conditions.

Calor

This is the main supplier of propane (red) gas cylinders and significant seller of butane (blue) gas.

Cassette Blind

This is a roller blind which is fitted as part of the window assembly, often along with a flyscreen, thus giving a neat installation.

Cassette Toilet

A form of chemical toilet found in modern vehicles, where the waste holding tank can be accessed and emptied from outside.

Chemical Toilet

A toilet that has a compartment in which waste is treated with chemicals.

Control Panel

Used as the description for the panel of electrical switches and gauges governing 12V and mains electricity systems.

CRiS

This is the Central Registration and Identification Scheme. It is a voluntary scheme which registers a vehicle. Allows you to check the legitimate right to ownership of the seller of a second-hand vehicle, and helps in the recovery of stolen vehicles.

Dinette

This is a popular style of seating arrangement where two seats or settees face each other across a table.

Earth Leakage Circuit Breaker

ELCB Earth leakage circuit breaker - see residual current device (RCD).

Essential Habitation Equipment

Those items and fluids required for the safe and proper functioning of the equipment for habitation as defined by the manufacturer of the vehicle. This includes items such as the leisure battery and gas cylinders, plus water contained in the water heater etc.

Flyscreens

Mesh fittings for windows doors and roof vents, to keep out insects etc.

Free-Standing Table

This is a table which, because of its leg design, can be used inside or outside.

Full Service Pitch

This is a pitch which has individual provision for fresh water supply and waste water disposal, in addition to mains electricity and in some cases TV aerial connection.

Gas Cylinder

This is a portable, pressurised container for the storage of LPG.

Gas Locker

Is the compartment on the caravan for the storage of gas cylinders.

Gas Drop out Holes

These are not part of the ventilation. LPG is heavier than air, so holes through the floor below gas-powered appliances allow any leakage of gas to exit the habitation area.

Gas Regulator

Safety device fitted between the gas cylinder and the gas system of a vehicle, which controls the pressure of gas being released from the cylinder.

Grey Water

This is the waste water from sink/shower.

Gross Train Weight

This is also known as Combined Weight. The maximum permitted weight of an outfit as specified by the tow vehicle manufacturer.

Gross Vehicle Weight (GVW)

This is the weight of the vehicle laden to its maximum, as defined by the manufacturer. See also MTPLM.

GRP

Is Glass-reinforced plastic, but more commonly known as glass fibre (not fibre glass, which is a trade name).

Handbook

This is a generic owners manual, a guide to the workings of your vehicle.

Hardstanding

This is a pitch which has a hard surface made of gravel, asphalt, concrete etc, instead of grass.

Hook-Up

This is a facility on a pitch for connection to mains electricity.

Ingress

The entry of water into the vehicle structure.

Jack

This is a device for raising the vehicle so that a wheel can be changed, for instance.

Note for caravans only - Not to be confused with corner steadies which although they are sometimes referred to as 'corner jacks' are steadying, not lifting devices.

Kerb Weight

This is the empty weight of a motor vehicle as defined by the manufacturer.

Layout

This is the interior design and details where furniture units are placed in relation to each other.

Leisure Battery

This supplies the power for the vehicle 12V systems and is sometimes called an auxiliary battery.

Levelling

The process of ensuring that a vehicle is level when sited on a pitch. It is important for comfort and also to ensure the correct functioning of the fridge and water systems.

LPG

Liquid Petroleum Gas, i.e. butane or propane.

L-Shaped

This is a term where the seating area of a vehicle is indeed L-shaped.

Mains Hook-Up

This is a campsite facility where you can plug into a mains electricity supply.

Maximum Permissible Towing

This is the maximum weight that the towing vehicle is allowed to tow.

Maximum User Payload

This is the maximum payload available for the user.

MIRO - Mass In Running Order

Weight of the vehicle equipped to the manufacturer's standard specification including essential habitational equipment.

MTPLM - Maximum Technically Permissible Laden Mass

The technical maximum permissible laden weight of the vehicle, this must not be exceeded.

NCC - National Caravan Council

The only trade association representing manufacturers, retailers and suppliers within the vehicle industry.

Optional Equipment Payload

A mass specified by the vehicle manufacturer for factory or pre-registration fitted options only.

Owners' Club

This is a group of people who usually own the same brand of vehicle and enjoy meeting up for rallies.

Payload

The amount you can put into a vehicle. Specifically the difference between the Maximum Technical Permissible Laden Mass (MTPLM) and the Mass In Running Order (MIRO).

PDI

This is an inspection undertaken by the Retailer prior to handover to the customer.

Pitch

A designated area of a vehicle site allocated for the use of one outfit. Most sites will be arranged with defined pitches.

Propane

Gas used in colder conditions and is usually supplied in red cylinders.

RCD

This is a residual current device and is part of the electrical system which will 'trip' if there is an electrical fault.

Road Lights

The external lights used while the vehicle is travelling.

Roof Lights - See Roof Vent.**Roof Vent**

Is an opening unit in the ceiling which lets in ventilation and light, these vary in size, but the best ones will have integral blinds and flyscreens and are also called rooflights.

Semi-Rigid Pipe work

Is water pipes made of a semi rigid plastic and are preferable to cheaper convoluted piping which can act as a trap for germs and smells.

Serial number

This is a unique serial identification number for a vehicle.

Slats

Sometimes used for beds and can improve ventilation to mattress cushions.

Space Heater

This is a type of heating equipment for the living quarters. Modern units fitted offer gas and mains-operation.

Speed Rating

This is the maximum speed at which a tyre may be used, as marked on its sidewall.

SMMT

Society of Motor Manufacturers and Traders.

Torque Wrench

A form of spanner used to set nuts and bolts to a specified degree of tightness. It is recommended for adjustment of wheel fixings on vehicle.

Towing Limit

See manufacturer's braked towing limit and manufacturer's unbraked towing limit.

User Payload

The weight of all items carried in the vehicle.

U-Shaped Settee

Usually a reference to seating that literally is 'U' shaped.

Vehicle Kerb weight

The weight of the tow car often indicated in the manufacturers specifications..

VIN - Vehicle Identification

Number This is a unique vehicle identification number. All Cars and motorhomes should carry a VIN. Caravans are not obliged to, but the serial number is used as part of the CRiS voluntary registration scheme.

Warranty

Are the terms and conditions that spell out your rights with regards to servicing, repair or replacement of parts as provided by the manufacturer.

Wild Camping

Term used for staying overnight away from a campsite. Illegal in many countries, but permission may be granted by individual landowners.

MOTORHOME HABITATION ANNUAL SERVICE RECORD

In order to ensure your warranty remains valid an annual service must be carried out in accordance with the requirements of this handbook. You are responsible for any charges incurred for the service

of your vehicle. If the annual service is performed by an authorised Erwin Hymer Group UK Approved Retailer / Service Centre or NCC Approved Workshop then Erwin Hymer Group UK Limited deems that the service has been performed correctly.

You may choose to have your annual service performed by an unauthorised repairer / service centre and if you do it will be your responsibility to ensure that the service meets our requirements.

We will ask you to provide a copy of the following documentation:

- Damp report
- Annual Habitation Service check list (to the minimum standard set out in this handbook)
- Invoice / dated service stamp

If the Annual Service has not been performed in accordance with the requirements in this handbook your warranty will be invalidated, however this will not affect your legal or statutory rights as a customer.

Erwin Hymer Group UK will not pay any unapproved Service Centre for the undertaking of any warranty work.

Minimum service requirements

The service must be undertaken by suitably qualified personnel.

A full damp test check should be undertaken and damp readings recorded. A service check must be performed to the minimum standards set out below.

Annual Habitation Service check list

UNDERBODY

Item	Condition
Under slung tanks and pipes - check condition and security	
Body Attachment - check security of body to the chassis	

ELECTRICAL SYSTEMS

Item	Condition
Check the leisure battery is being charged from both the engine when running, or with a multi-tester and the mains charger	
Leisure Battery (if fitted) - check condition of the battery & its compartment	
Interior lighting & equipment - check operation and fuse rating	
Awning light - check operation	
Wiring earths - check for defects on all ELV circuits (Visual)	
LV inlet plug & extension lead – check condition & resistance across pins	
Earth Bonding - visual inspection	

ELECTRICAL SYSTEMS (continued)

Item	Condition
RCD unit - check operation of RCD test button and operations of MCBs	
230V appliances - check operation	
3 pin plug - check condition	

GAS SYSTEMS

Item	Condition
Regulator and gas hose - check age performance and security	
Perform a gas pressure check	
LPG Tank (if fitted) - check security	
Flame failure devices - check operation	
Gas cylinder - check security	
Gas dispersal holes - check they are clear from obstructions.	

APPLIANCES (check gas and electric operation)

Item	Condition
Fridge - check operation from 12V, 230V & gas	
Hob - check operation	
Oven - check operation	
Grill and fan - check operation	
Water boiler – Check operation	
Heater - check operation and top up header tank with anti-freeze (where applicable), bleed as necessary	

WATER SYSTEM

Item	Condition
Water pump & pressure switch - check operation	
Taps and pipes - check operation	
Water filter housing - check for leaks & replace filter where necessary	
Water system - check for leaks	
Water Tanks (if fitted) - check security of all water tanks including underslung tanks.	
Toilet - check security, operation of flush pump and free from obstructions	
Drain down the system when checks are complete.	

SERVICE DOCUMENTS

VENTILATION

Item	Condition
Rooflights - check all are free from obstructions, cracks and have a free air flow	
Floor vents - remove protective cover and check they are clear from obstruction then refit covers	

FIRE & SAFETY

Item	Condition
Smoke and carbon dioxide detectors - check for operation via the test buttons fitted, check battery condition.	
Fire Extinguisher (if fitted) - check it is still within date	
Fire Blanket (if fitted) - check it is still within date	
Habitation door operation	

BODYWORK

Item	Condition
Doors and windows - check all catches are present and operating correctly.	
Blinds and flyscreens - check condition and operation	
Roof - check condition of roof.	
Cab seats - check condition of the seats and seats belts	
Floor - check condition of floor	
Furniture - check condition of the furniture	
Damp Test - undertake a damp test and record all readings taken.	
Lubricate all locks	

ANNUAL HABITATION SERVICE RECORDS

ANNUAL SERVICE RECORD

MOTORHOME MODEL

VEHICLE IDENTIFICATION NUMBER YEAR

1st SERVICE

DATE:

RETAILERS STAMP:

I/We certify that an annual service has been carried out in accordance with the manufacturers' and NCC recommendations.

2nd SERVICE

DATE:

RETAILERS STAMP:

I/We certify that an annual service has been carried out in accordance with the manufacturers' and NCC recommendations.

3rd SERVICE

DATE:

RETAILERS STAMP:

I/We certify that an annual service has been carried out in accordance with the manufacturers' and NCC recommendations.

4th SERVICE

DATE:

RETAILERS STAMP:

I/We certify that an annual service has been carried out in accordance with the manufacturers' and NCC recommendations.

5th SERVICE

DATE:

RETAILERS STAMP:

I/We certify that an annual service has been carried out in accordance with the manufacturers' and NCC recommendations.

6th SERVICE

DATE:

RETAILERS STAMP:

I/We certify that an annual service has been carried out in accordance with the manufacturers' and NCC recommendations.

SERVICE DOCUMENTS

7th SERVICE

DATE:

RETAILERS STAMP:

I/We certify that an annual service has been carried out in accordance with the manufacturers' and NCC recommendations.

8th SERVICE

DATE:

RETAILERS STAMP:

I/We certify that an annual service has been carried out in accordance with the manufacturers' and NCC recommendations.

9th SERVICE

DATE:

RETAILERS STAMP:

I/We certify that an annual service has been carried out in accordance with the manufacturers' and NCC recommendations.

10th SERVICE

DATE:

RETAILERS STAMP:

I/We certify that an annual service has been carried out in accordance with the manufacturers' and NCC recommendations.

11th SERVICE

DATE:

RETAILERS STAMP:

I/We certify that an annual service has been carried out in accordance with the manufacturers' and NCC recommendations.

12th SERVICE

DATE:

RETAILERS STAMP:

I/We certify that an annual service has been carried out in accordance with the manufacturers' and NCC recommendations.

13th SERVICE

DATE:

RETAILERS STAMP:

I/We certify that an annual service has been carried out in accordance with the manufacturers' and NCC recommendations.

14th SERVICE

DATE:

RETAILERS STAMP:

I/We certify that an annual service has been carried out in accordance with the manufacturers' and NCC recommendations.

NOTIFICATION OF CHANGE OF OWNERSHIP

If you purchase this vehicle as a used vehicle it may be possible to transfer the unexpired term of the warranty cover (up to a maximum of six years commencing at the original date of purchase from new). Please refer to the warranty section of the handbook for terms and conditions.

Please complete the attached form and post it to us along with the following information:

- A copy of the V5 registration form
- A copy of the habitation service handbook displaying a complete and up to date service history, including service checklist and damp report.
- Please contact the customer care team to arrange payment.

Transfer of ownership must be made within the first three months of any change of legal ownership in order for the warranty cover to remain valid.

Erwin Hymer Group UK Limited Customer Care Delves
lane
Consett
County Durham
DH8 7PE
www.elddis.co.uk

Email documents to customer.care@erwinhymergroup.co.uk payment can be taken over the phone

NOTIFICATION OF CHANGE OF OWNERSHIP

Previous owner details (if known):

Name:

Address:

.....

..... Post code:

Email:

New owner details:

Name:

Address:

.....

..... Post code:

Email:

Daytime telephone number: Date of purchase:

Details of Motorhome:

Range: Model:

Vehicle identification number (17 digits):

* In order for you warranty to remain valid, your motorhome must have been serviced annually by an Approved Retailer / Service Centre, NCC Approved Workshop or NCC equivalent standard as set out in this handbook. If you do not want to receive information about products and services from Erwin Hymer Group UK, please tick.

NOTIFICATION OF CHANGE TO NAME AND ADDRESS

In order that we can provide you with the very best level of service we ask that you keep us informed of any changes to your contact details.

Should your details change please complete the attached form and post to us: Erwin

Hymer Group UK Limited Customer Care

Delves Lane

Consett

County Durham

DH8 7PE

www.elddis.co.uk

Email documents to customer.care@erwinhymergroup.co.uk

.....
NOTIFICATION OF CHANGE TO NAME AND ADDRESS

Previous details:

Name:

Address:

.....

..... Post code:

Email:

New details:

Name:

Address:

.....

..... Post code:

Daytime telephone number: Date of purchase:

mail:

Details of your Motorhome:

Range: Model:

Vehicle identification number (17 digits):

If you do not want to receive information about products and services from Erwin Hymer Group UK, please tick.

A

Alarm system 9-1

B

Battery Maintenance 7-1, 11-1

Bed make up 8-81, 8-84, 8-87

Bicycle racks.....8-108, 3-2

C

Care of your Motorhome

Exterior Cleaning 10-1

Code of Practice

Remedial Work 12-4

D

Door operation 8-3

E

Electrical System 7-1

Electricity..... 6-1

Connecting To Mains Supply ... 6-1

Disconnecting Mains Supply 6-2

Mains Supply 6-1

Overseas Electrical

Connection..... 6-2

G

Gas 6-3

Connection 6-4

Hoses 6-6

Regulator 6-4, 6-5

Gas Regulator..... 6-5

Gas Safety Advice..... 6-3

Glossary..... 16-1

H

Heating System

Alde 8-21

I

Insulation..... 13-1

L

Levelling..... 5-1

Loading 3-1

M

Mains Unit 7-1

Motorhome Construction

Main Components 13-1

Motorhome Construction -

Main Components

Solid Construction

Body Shell..... 13-1

Windows..... 13-1

N

Notification of Change of
 Ownership 18-1
 Notification of Change to
 Name and Address..... 19-1

R

Refrigerator.....8-35

S

Safety, general.....2-1
 Security.....9-1
 Service records..... 17-4
 Site Regulations.....5-1
 Storage
 Long Term & Winter 11-1

T

Taps.....8-68
 Toilet
 Thetford C2608-71

V

Ventilation.....2-2

W

Water System6-7
 Wiring diagram 14-1, 14-2