



Compass

camino

Touring Caravan
OWNERS
HANDBOOK

Issue 1



WELCOME AND INTRODUCTION	1-1	Overseas Electrical Connection	6-2
Model Year Designation	1-1	Gas Safety Advice	6-3
Elddis Technical Approvals	1-2	Facts about LPG	6-3
GENERAL SAFETY	2-1	Awning Spaces, LPG and Appliance Exhaust	6-3
Please read before using your new Caravan	2-1	LPG Gas System	6-3
Ventilation	2-2	Gas Supply	6-4
High-Level Ventilation	2-2	Connection	6-4
Low-Level Ventilation	2-2	Changing a Gas Cylinder	6-4
Ventilation in Separate Bedrooms	2-2	Auto Changeover Gas Regulator	6-5
Gas Dispersal Holes	2-2	High Pressure Gas Hoses	6-6
Petrol/Diesel Fumes	2-2	Whale High Flow Pump with Intelligent Control®	6-7
Fire Safety	2-2	ELECTRICAL SYSTEM	7-1
In Case Of Fire	2-2	12v Power Supply	7-1
Fire Retardant Foams	2-2	Battery Installation	7-1
Escape Paths	2-2	Battery Maintenance	7-1
Your Caravan Payload Explained	2-3	Generators / Charger	7-1
PREPARING FOR THE ROAD	3-1	230v Power Supply	7-2
Caravan Towing Vehicle Weight Ratio	3-1	Mains Unit	7-2
Loading	3-1	Resetting the RCD	7-2
Internal Loading & Checks	3-1	Automatic Charging System	7-2
External Loading & Checks	3-2	Internal Lights	7-2
Pre-Tow Checklist & Hitch-Up	3-2	Maximum Power Ratings for Internal Lights	7-2
Reversing	4-1	Connecting a Solar Panel and/or Satellite Dish (Option only)	7-3
Speed Limits	4-1	External Solar Panel Connection	7-3
Setting Off	4-1	External Satellite TV Connection	7-3
Caravan Handling	4-1	HOW TO USE YOUR CARAVAN'S EQUIPMENT	8-1
Motorway Driving	4-2	Electrical Control Panels	8-1
Towing Covers	4-2	Oven, Hob and Grill	8-2
Tyre and Wheel Checks	4-2	Safety	8-2
ARRIVING ON SITE	5-1	Use of the Burners	8-4
Check Site Regulations	5-1	Use of the Electric Hotplate (if applicable)	8-4
Selecting a Pitch	5-1	Use of the Grill	8-5
Side-To-Side Levelling	5-1	Use of the Oven	8-5
Leveller Jack	5-1	Safe Cooking	8-6
Ramp	5-1	Temperature Control	8-6
Front & Back Levelling	5-1	Maintenance and Cleaning	8-7
Parking on a Reverse-Sloping Site or Steep Hill	5-2	Refrigerator	8-8
Entering and Exiting the Caravan	5-2	Alde Heating (3020 Control Panel)	8-11
GETTING STARTED	6-1	Turning the Boiler On and Off	8-11
Electricity	6-1	Standby	8-11
Power Supply Charger	6-1	Settings Menu	8-12
12v Systems:	6-1	Set the Desired Temperature	8-12
Generator/Charger	6-1	Domestic Hot Water	8-12
Electricity Mains Supply	6-1	Heating with Electricity	8-13
Connecting To Mains Supply On Arrival at Site	6-1	Heating with Gas	8-14
Disconnecting Mains Supply When Leaving Site	6-2		



*Fully Automatic Climate Control (ACC)	8-14	Digital TV set-up Guide	8-47
Activated Functions A	8-15	Connect Aerial and Power	8-47
Tools Menu	8-16	Troubleshooting Guide	8-47
Tools Menu - Functions	8-16	Protect - Autowatch Alarm System	8-49
Service Menu	8-20	Basic Operation Arming the System	8-49
Fluid level of heating system	8-21	Disarming the System	8-49
Microwave (when installed)	8-22	Panic Alarm	8-49
Battery Charger	8-23	Emergency Disarm	8-49
Smoke Alarm	8-23	Silent Arm and Disarm	8-49
Carbon Monoxide Alarm	8-25	Sensors	8-49
Thetford C-260 Cassette Toilet Range	8-29	Passive Infra Red Sensor	8-49
Preparing for Use (Standard)	8-29	Al-Ko Trailer - Control	8-50
Preparing for Use with		Whale Easi-Slide Socket	8-51
Optional Features	8-29	Safety Information	8-51
Using the Toilet (Standard)	8-31	SECURITY	9-1
Using the Toilet with Optional Features	8-31	Caravan Theft	9-1
Emptying	8-31	Tracker Retrieve	9-1
Emptying with Optional Features	8-31	CRIS - The Caravan Registration and	
Cleaning and Maintenance	8-32	Identification Scheme	9-1
Toilet Bowl	8-32	Al-Ko Secure Wheel Lock (Option)	9-2
Waste Holding Tank	8-32	Window & Chassis Marking	9-4
Cleaning and Maintenance for		Electronic Tagging	9-4
Optional Features	8-33	CARE OF YOUR CARAVAN	10-1
Winter Operation	8-33	Exterior Cleaning	10-1
Storage	8-33	Wheels	10-1
Toilet Unit Malfunctions	8-33	Glass Fibre Reinforced Plastic	
Rooflights	8-35	(GRP - where applicable)	10-1
The Omivent (12v) Rooflight	8-35	Acrylic Windows	10-1
The Heki 2 Rooflight	8-35	Window Blinds & Flyscreens	10-1
Midi Heki Rooflight	8-36	Winterisation/Storage	10-1
MPK Rooflight	8-37	ABS - A Frame Cover, Wheel Spats	
Stargazer Rooflight (if fitted)	8-37	& Panels	10-2
Windows	8-38	Interior Walls	10-2
Polyplastic Window Opening	8-38	Furniture	10-2
Blinds & Flyscreens	8-38	Cooking Equipment	10-2
Door Flyscreen	8-38	Soft Furnishings	10-2
Shower	8-39	Winterisation and Storage	10-3
Taps	8-39	Shower Trays, Shower Room	
Internal Doors	8-40	and Wash Basin Fittings	10-3
Toilet/Shower Room Doors	8-40	Cleaning of all Taps	10-3
Gas Locker Door	8-40	Water Containers	10-4
High Level Locker	8-40	Water Systems - Sterilisation	10-4
Concealed Latch	8-40	Thetford Toilet	10-4
Magnetic Catches	8-41	Chassis Mounted Spare Wheel Carrier	10-5
Room Divider	8-41	Tyres	10-5
Bed Make-up	8-42	Pressures	10-5
Front Wrap Round Seating (Option)	8-44	Tyre Wear and Damage	10-5
Lift Up Bed Extensions (where fitted)	8-44	Changing a Wheel	10-5
Removable Drawers	8-44	Jacking	10-6
Radio with MP3 Connectivity	8-44	Lubrication	10-6
Teleco TV Aerial	8-45		
How to use your TV Aerial	8-47		



The Alko Caravan Chassis	10-7
Chassis Members	10-7
Drilling or welding of parts or Accessories	10-7
Independent Suspension	10-7
Coupling Head	10-7
Brake Drum/Hub Assembly	10-7
Operating Instructions	10-8
Braking System Adjustment	10-10
STORAGE	11-1
Long Term & Winter Storage	11-1
caravan covers	11-1
Power Drain	11-1
CARAVAN WARRANTY COVER	12-1
Non Warranty Repairs	12-3
Remedial Work	12-4
CARAVAN CONSTRUCTION - MAIN COMPONENTS	13-1
Alko Chassis	13-1
Braking System	13-1
Solid Construction Body Shell	13-1
Windows	13-1
Insulation	13-1
Front Panel and Gas Bottle Locker Door	13-1
Awning Channel	13-1
WIRING DIAGRAM	14-1
Road Lights	14-2
GENERAL QUESTIONS	15-1
GLOSSARY	16-1
SERVICE DOCUMENTS	17-1
NOTIFICATION OF CHANGE OF OWNERSHIP	18-1
NOTIFICATION OF CHANGE TO NAME AND ADDRESS	19-1
USEFUL ADDRESSES	20-1
INDEX	21-1



WELCOME AND INTRODUCTION

Congratulations on selecting your new Touring Caravan.

This Owner's Handbook has been prepared for your guidance to help you derive the greatest amount of pleasure from the use of your caravan and your leisure time. We strongly recommend that you read this guide thoroughly so that you are fully aware of all the caravan's features, equipment and systems.

Additional information and detailed appliance instruction manuals are also contained in your Owner's Information Pack which can be found within the kit box supplied with your caravan.

Your new caravan has been designed as a recreational vehicle and is intended for recreational use only. It is not intended for business, hire use or for permanent habitation. Elddis accepts no liability if the caravan is used for any purpose other than recreational/holiday use. Any use other than recreational/holiday use will invalidate your warranty.

Your new caravan is designed to be towed by a normal motor car.

If you intend to tow it with a pick-up type vehicle, passenger derived van or a 4x4 type vehicle, additional care should be exercised because of the potential for a harder rear suspension on such vehicles which may impose excessive loads onto the caravan.

You may also have to adjust your driving style over rough terrain and particular attention should be given to the height of the tow ball in relation to the caravan coupling.

Ref: (United Nations Economic Commission for Europe) UNECE R55 states that the centre of the towball should be between 350mm and 420mm above the ground level.

Your new caravan should not be towed by a commercial vehicle with a gross vehicle weight in excess of 3500 kgs.

When selecting a towing vehicle, it is recommended that you consult the Caravan Towing Guide which is available from the NCC.

By following the instructions provided in this handbook and maintaining your caravan in a first class roadworthy condition, you are sure to have many years of carefree use.

To ensure the very best quality and reliability all touring caravan designs and new developments are rigorously tested. Therefore Elddis will accept no liability or uphold the warranty if the caravan is altered or modified in such a way that would adversely affect the reliability.

Please note: It is a condition of your warranty that the caravan must have an "annual service" carried out by an Elddis approved Retailer / Service Centre or NCC Approved workshop or NCC equivalent standard as set out in this handbook and a record is kept. Pages are provided in the back of this guide, for your assistance.

An Elddis Approved Retailer / Service Centre will be able to supply any replacement parts for your caravan, should the need arise, and in most cases any accessories you may require.

Please note: It is not possible to purchase replacement parts direct from Elddis.

Changing market and supply situations may prevent us from maintaining the exact specification details in this guide and we therefore reserve the right to alter specifications as materials and conditions demand.

Enjoy your new caravan

IMPORTANT: Register your vehicle with us

In order to fully protect your valuable purchase, we would kindly ask you to take a few moments to complete our online Warranty Registration.

Registering your vehicle will ensure that we always have the most accurate and up-to-date contact information and all of your vehicle details to hand, should you ever need our assistance.

Your feedback is incredibly important to us and helps shape the future of our leisure vehicles. We would be delighted if you would also complete our accompanying online Customer Questionnaire.



Compass

INTRODUCTION



Both our **Registration** form and our **Customer Questionnaire** can be found on our Homepage: www.elddis.co.uk

Please note that this is not for warranty purposes. Warranty registration must be done by the selling retailer.

Model Year Designation

All Touring caravans manufactured by Elddis are designated by their model year. The 2021 model year runs from 1st September 2020 to 31st August 2021.

Elddis Technical Approvals

All Elddis Caravans have been European Commission Whole Vehicle Type Approved.

In order to ensure your new caravan is safe to use, Elddis are members of and have been inspected by the following bodies.

NCC who operated a certification scheme to ensure compliance with the European safety standards for caravans.

Elddis has also obtained ISO9001:2015 accreditation and this is periodically audited.



GENERAL SAFETY

Please read before using your new caravan.

In order for you to get the most out of your new caravan it is necessary for you to be aware of the following:

- (i) Do not obstruct ventilators and clean them regularly, it is advisable to clean and check all the ventilators annually for blockages and where necessary rectify any blockages found.
- (ii) Inspect the high pressure flexible gas hose (available from your retailer) regularly for deterioration and renew as necessary, with an approved type, in any case no later than the expiry date stated on the hose.
- (iii) Ensure the gas supply and all appliances are turned off before towing your caravan.
- (iv) If your caravan has been fitted with a gas BBQ point it must be only used for its intended purpose. **Do not use a gas barbeque within an awning.**
- (v) Never allow modification to your gas or electrical system unless qualified persons carry them out. All modification to the gas system should be carried out by a Gas Safe Register™ approved gas fitter. Any modifications carried out on the electrical system must be carried out by a suitably qualified electrician. Never use portable cooking or heating equipment inside your caravan. Do not use your fitted cooking equipment as heating at any time.
- (vi) In the interest of safety, replacement parts for an appliance should conform to the appliance manufacturer's specifications and must be fitted by them or an authorised agent.
- (vii) If you suspect there is a gas leak please open all the windows then vacate the caravan. Turn off the gas container if safe to do so, then contact your nearest Eddis Retailer to arrange for them to check the gas system.
- (viii) Never exceed your caravans Maximum Technical Permissible Laden Mass. (see Caravan Towing Vehicle Weight Ratio)
- (ix) The laden nose weight for your caravan should not exceed the lower of the following:
 - Towing vehicles maximum nose weight
 - Tow bar maximum nose weight
 - The caravan's maximum nose weight.
- (x) Ensure heavy and large items are secured before towing your new caravan to reduce the risk of damage being caused while the caravan is in motion.
- (xi) Pull out/lift up worktop extensions, where fitted, are only designed to take a maximum weight of 6kgs.
- (xii) When your caravan is connected to your towing vehicle it should be level or slightly nose down.
- (xiii) Where high level bunks are fitted, care should be taken when used by children. The protection against falling out must be in place when the bunk is used.
- (xiv) When your caravan is loaded to its MTPLM and the weight distributed in accordance with the handbook, your caravan is designed to be towed at a maximum speed of 100kmh/60mph.
- (xv) **It is illegal to tow your caravan whilst it is occupied.**
- (xvi) If your caravan is fitted with a lift up or high level bunk it is designed for a maximum weight of 11 stone and is not suitable for children under 6 years old without supervision.
- (xvii) Do not leave children under 14 years of age unattended in your caravan.
- (xviii) Your vehicles MIRO is calculated with no water on board. To travel with water you must take account of the water in your vehicle payload. 1 litre of water = 1Kg.
- (xix) Where a dividing curtain is fitted or provided, please ensure when not in use it is stored in the position furthest away from any cooking equipment or in the storage housing if provided.



VENTILATION

All caravans manufactured by Elddis are ventilated at both high and low level in accordance with BSEN 721 Safety Ventilation.

High-Level Ventilation

This is mainly provided by fixed ventilation within the fitted roof skylight. These roof skylights should be cleaned annually by use of a small brush to remove any dust that may have accumulated around the mesh fitted. On some roof skylights the mesh can be easily removed to aid cleaning. On fan-assisted roof skylights it is essential that the fan is switched off prior to cleaning.

High level ventilation may also be provided by additional fitted mushroom vents.

Low-Level Ventilation

Low level ventilation is provided within the living area of your new caravan and these can be identified by the fitting of a black cover to prevent them from being obstructed. This cover must not be removed. In order to clean the ventilator, remove the cover by undoing the two screws and clean using a small brush. It is essential that the cover is replaced once cleaning is complete.

Ventilation in Separate Bedrooms

In caravans with separated sleeping areas, separate ventilation is required and is provided via a roof skylight at high level and a ventilator at low level within a bed box or under the fixed bed.

Gas Dispersal Holes

All appliances and gas taps have a gas dispersal hole within the same compartment. It is essential that these are not blocked or made ineffective.

Petrol/Diesel Fumes

The fitting of a tail pipe to your exhaust will reduce the possibility of fumes entering your caravan through the front fixed ventilation points.

FIRE SAFETY

It is recommended that one dry powder fire extinguisher complying with EN 3-7 of at least 1kg capacity or equivalent is provided by the main door and a fire blanket next to the cooker. Familiarise yourself with the instruction on your fire extinguisher and the local fire precaution arrangements.

In Case Of Fire

- (i) Get everyone out of the caravan as quickly as possible using whichever exit is quickest including windows. Do not stop to collect any personal items.
- (ii) Raise the alarm. Call the fire brigade.
- (iii) Turn off the gas container valve if safe to do so.
- (iv) Retreat to a safe distance.

Fire Retardant Foams

All caravans are equipped with Polyurethane (PU) foam which are combustion modified foam cushions, mattresses and fire retardant fabric. All furnishings and fabrics used by Elddis comply with the Furniture and Furnishings (Fire Safety) Regulations. In addition all upholstery is made of fire retardant fabric.

Escape Paths

Your new touring caravan has been provided with escape paths to be used in the event of an emergency. One of which is always the main habitation door and others are the large windows to be used where necessary. Care must be taken when exiting via a window due to the potential drop to ground level.

IMPORTANT: Your attention is drawn to the notice affixed in the caravan's wardrobe advising on fire prevention, ventilation and what to do in case of fire.

Please note: Do not work under the caravan unless the corner steadies are down and the axle is supported.



YOUR CARAVAN PAYLOAD EXPLAINED

Definitions

Plated maximum technical permissible laden mass (PMTPLM)

As specified by Eddis and in compliance with the European Directive on Masses and dimensions of vehicles.

Actual MTPLM

Maximum mass of the vehicle, which takes into account operating conditions including, factors such as the strength of materials, loading capacity of the tyres etc.

Mass of the caravan in running order (MIRO)

This is the weight of your caravan as it leaves our factory plus the following:

A mass of 10kgs per gas cylinder, the cylinder number is equal to the number of connections provided at the regulator.

Personal effects payload (PEP)

This is calculated by the following formula:

$$10L + 10N + 50$$

L is the body length of the caravan in meters.

N is the number of berths.

50 is for normal equipment carried in the caravan, a sample list is given below.

Kettle	0.5kgs
Bed linen	6kgs
Crockery	5kgs
Saucepans	3kgs
Wastemaster	6kgs
Aquaroll (empty)	5kgs
Waste bin	1kg
Cutlery	2kgs
Toilet fluid etc	2.5kgs
Battery	25kgs

Optional equipment payload (OEP)

This is an amount of weight provided for factory fitted options.

Please note: Any options fitted by the retailer will reduce the overall payload available to the customer.

User Payload is the sum of the PEP and the OEP.

Note: It may be possible to upgrade your Plated MTPLM to the Actual MTPLM up to the caravan being 3 years old, there is an administration fee for this service.

Note: Please ensure you never load your caravan above the plated MTPLM.

Note: Please take care to ensure you have allowed for the mass of all the items you intend to take in your caravan.



PREPARING FOR THE ROAD

CARAVAN TOWING VEHICLE WEIGHT RATIO

This ratio has a major influence on stability. It is recommended that:

- (i) The laden nose weight for your caravan should not exceed the **lower** of the following:
 - * Towing vehicles maximum nose weight,
 - * Tow bar maximum nose weight
 - * The caravan's maximum nose weight. Please refer to the caravan weight plate for this information.
- (ii) The actual laden weight of the caravan should always be kept as light as possible. The lighter it is whilst being towed on a road, the safer the outfit combination will be.
- (iii) What you are able to tow is dependent on your driving licence.
- (iv) If you are a B licence holder you can only tow a car/caravan combination of total weight not exceeding 3500kgs and the cars kerb weight must be greater than the caravans plated MTPLM.
Note: It is strongly recommended that the caravan plated MTPLM should not exceed the cars kerb weight.
- (v) Your driving licence category determines the weight you can tow. Please refer to gov.uk for the most up to date information.
- (vi) The greater the actual laden weight of the caravan in relation to the kerb weight of the towing vehicle the more careful and experienced the driver needs to be and the lower the speed at which instability could occur.

WARNING: It is strongly recommended the loaded weight of the caravan does not exceed the kerb weight of the towing vehicle.

LOADING

Always lower and secure the jockey wheel and the four corner steadies (with the brace provided) before entering the caravan. This will ensure that the caravan does not tip up when you are inside.

Please note: Corner steadies should not be used as a jacking device.

Internal Loading & Checks

When loading your caravan it is advisable to:

- (i) Distribute items evenly over the axle and as low as possible to optimise road holding and achieve the best possible braking effect.
- (ii) Do not overload on one side as this will cause the caravan to lean and affect the road holding and stability.
- (iii) Do not stow tins, bottles or heavy items in overhead lockers when towing.
- (iv) Loose articles should be stowed securely to avoid movement and possible damage.
- (v) Ensure that all lockers, cupboard doors and showers doors are closed and room partitions are secured.
- (vi) Secure all bunks (if appropriate).
- (vii) Store the main dining table in its transit position.
- (viii) Set the refrigerator for 12V operation if any fresh food is stored in it and ensure the door is locked.
- (ix) Fully close and lock all windows and rooflights. Never tow with windows on night setting.
- (x) Leave all curtains and blinds open to prevent damage in transit. If your caravan has a rear window this may aid visibility.
- (xi) Ensure you remove all items from the microwave.
- (xii) Ensure the hob lid is in the closed position.



External Loading & Checks

- (i) Gas cylinders should only be stored, correctly positioned, and secured in the gas bottle locker. The gas should be turned off.
- (ii) The leisure battery is stored and secured in the battery locker box, set into the tray provided and secured.
- (iii) Any external connections (battery chargers, connecting cables etc), should be disconnected and stowed.
- (iv) Check that all exterior locker doors are secure and locked.
- (v) Secure and lock the main caravan entrance door.

PRE-TOW CHECKLIST & HITCH-UP

Having loaded the touring caravan and secured the lockers and main entrance door:

- (i) Check touring caravan wheel bolts are torque tightened to the required level (See Index - Changing a Wheel).
- (ii) Check tyre pressures (Refer to the Technical Data Sheet) and tyre condition for roadworthiness.
- (iii) Ensure the jockey wheel is down, in good contact with the ground, clamp tightly secured, and the caravan handbrake is fully on.
- (iv) Raise the corner steadies.
- (v) Reverse the car close up to the caravan's hitch. It is advisable to seek assistance to guide you so that the car tow ball aligns with the caravan's hitch. (Use of the caravan handbrake is advised. Extreme caution should be taken if manoeuvring the caravan down hill or on wet, slippery surfaces).
- (vi) Make sure the jockey wheel height is sufficient for the hitch head to clear the towing vehicles tow ball.
- (v) Manoeuvre the hitch head over the tow ball and lower the jockey wheel using the winding handle, until the hitch head opening sits comfortably over the tow bar ball.

CABLES

For peace of mind, you may wish to check the ability of the cables to be able to cope with towing the vehicle at extreme angles before setting off. To do so, position the vehicle at alternate extreme angles and check that the cables do not pull too tight, as they are liable to stretch or become unplugged. No cables should be allowed to touch the ground as they will wear and become damaged and ineffective.

Please note: If having followed this advice, you feel you cannot achieve a satisfactory cable arrangement, consult your caravan or tow bar supplier or service agent.

Stabiliser operating instructions

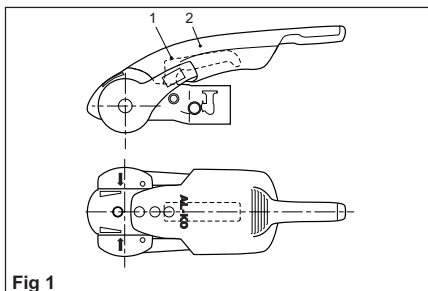

Fig 1

Coupling handle (Fig. 1/Item 1), Stabiliser Lever (Fig. 1/Item 2)

The Stabiliser lever (Fig. 2/Item 2) must be in the uppermost position (open).

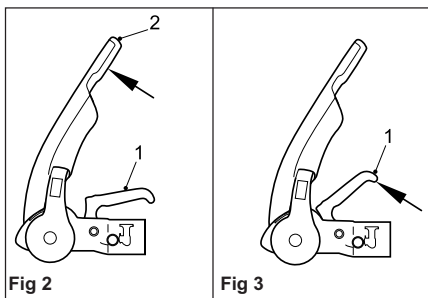

Fig 2

Fig 3

Coupling

- Pull the coupling handle (Fig. 3/Item 1) up in the direction of arrow. The coupling mechanism has an open position ie. as



long as the AKS 3004 is not placed on the ball, the handle will remain open. Put the opened coupling onto the clean towball. The handle must now make an audible click and return to the flat position.

WARNING: The coupling is correctly engaged when the green edge of the safety indicator button is visible (Fig. 4/Item 3).

WARNING: Always ensure that the jockey wheel is fully raised and secure before commencing any journey.

Stabiliser Unit:

- To operate the Stabiliser (once coupled to the towball), simple press the stabiliser lever down as far as it will go (Fig. 4/Item 2).

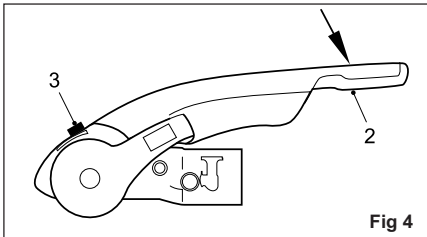

Fig 4

Uncoupling

- Pull the stabiliser lever handle up as far as it will go, open the coupling handle and lift the AKS 3004 from the towball. With larger nose loads, coupling and uncoupling can be made easier by using the jockey wheel to assist lifting.

The friction pads are pressed against the towball and hence generate a stabilising/damping force. These pads are therefore subject to wear over time, however they will have a long service life (circa. 30,000 Miles), provided they are well maintained and kept free of grease/dirt.

Checking the efficiency of the left/right friction pads:

- Couple up AKS 3004
- Open Stabiliser lever (Fig. 5/Item1).

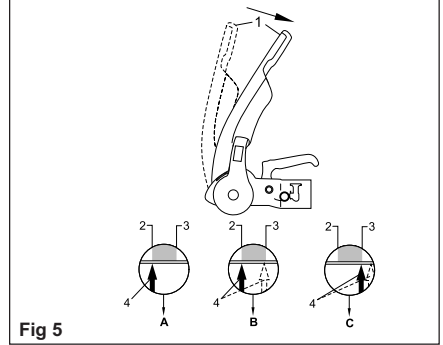

Fig 5

- Close Stabiliser lever until resistance is felt (ie friction pads are in contact with the ball but not yet under pressure).
- If the arrow on the arm (Fig. 5/Item 4) is before or on the marked area (Fig. 5/Item 2) the friction pads are still as new (See A)
- The arrow on the arm should lie between the marked area on the soft dock (See B)
- If the arrow on the plate reaches or passes the marked area on the soft dock then the friction pads need replacing (See C).

It is not necessary to adjust the friction pads.



Manoeuvring operation

For easier manoeuvring (on campsites etc), pull the stabiliser lever to the 'up' position.

Please do not use the stabiliser lever as an manoeuvring handle. Please use the handles on the Caravan or fit the AL-KO manoeuvring handle to your jockey wheel (available separately).

1) During opening or closing, the AKS must only be operated by one person.

2) Press stabiliser lever down by hand force only DO NOT use your foot or an extension bar, this will damage the components (Fig. 6).

3) When opening or closing the stabiliser lever, please ensure your hand does not touch the coupling handle - you may accidentally trap your fingers! (Fig. 6).

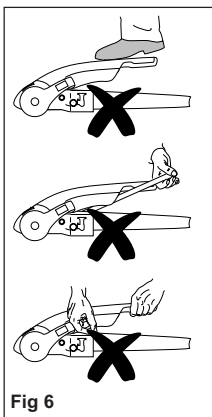



BREAKAWAY CABLE

The law requires that any trailer with a MTPLM (GVW) exceeding 750 kg must have a braking system and it must work. If such a trailer becomes detached from the tow vehicle then these brakes must be applied automatically by way of the breakaway cable.

This breakaway cable is an important part of the management of the braking system and when the trailer is built the braking system is part of the certification process for the safe use of the trailer - so any replacement parts must be equivalent to the original parts fitted. There are two types of breakaway cable in use in the UK. One uses a spring clip, the other uses a Karabiner clip.

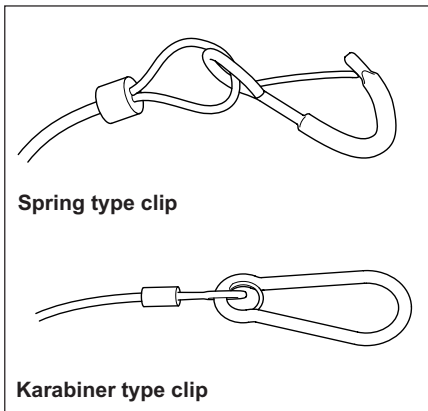

Looking at the two clips it is easy to see that there is a difference.

The spring clip type is designed to be hooked back over the breakaway cable when it is fitted to the tow vehicle and must always be used this way.

The Karabiner type is designed to be secured onto a mounting point on the tow vehicle, it does not need to pass back over the cable to secure it in place (but can if necessary).

So how should the breakaway cable be secured to the tow vehicle? In the absence of specific advice from the manufacturer/supplier follow these simple guidelines:

Fixed tow ball systems

The cable with spring clip should be passed behind the towbar assembly (where cable length is sufficient) and then clipped back on itself. The cable should be in as straight a path as possible to ensure correct operation.

When the breakaway cable is attached, check to ensure:

- that the cable cannot snag in use on the trailer coupling head, jockey wheel, or any accessory e.g. a stabiliser, bumper shield, cycle carrier etc.
- that there is sufficient slack in the cable to allow the towing vehicle and trailer to articulate fully without the cable ever becoming taut and applying the brakes.

Where a designated attachment point is provided on the towbar:

Either

- Pass the cable through the attachment point and clip it back on itself (Fig. 1).

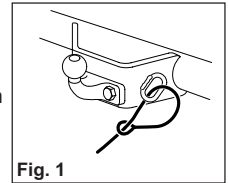

Fig. 1

Or:

- Attach the clip directly to the designated point (Fig. 2). This alternative must be specifically permitted by the trailer manufacturer since the clip may not be sufficiently strong for use in this way.

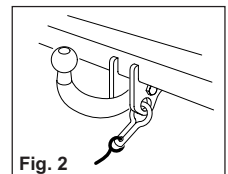

Fig. 2



Where NO designated attachment point is provided on the towbar:

Fixed ball

Loop the cable around the neck of the towball. If you fit the cable like this, use a single loop only (see figs 3A and 3B).

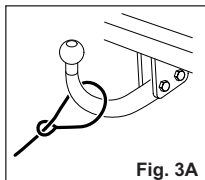

Fig. 3A

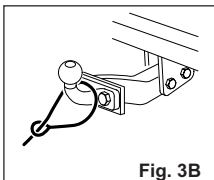

Fig. 3B

Detachable ball

You must seek guidance on procedure from the towbar manufacturer or supplier.

Where there is insufficient cable length then the cable should pass around the base of the tow ball and then be clipped back on itself.

Detachable tow bar systems

Vehicles with a detachable tow bar system may have a securing point provided on the tow bar assembly. This securing point should be part of the towbar assembly fitted to the tow vehicle but this securing point may not be large enough to allow the spring clip type fastener to pass completely through, do not be tempted to clip onto the securing point directly. Where this is the case, or where there is no hooking point provided, then the cable should pass around the tow ball assembly and then clipped back on itself.

Where the towbar provides a securing point and a Karabiner type fastening is provided, then this can be secured to the securing point. Make sure that it is completely closed to ensure that it operates correctly.

Be careful to check that the cable does not sag so much that it could drag on the ground - if it does it may become damaged or catch on debris on the road surface. Also ensure that the cable is long enough to allow for any sharp turns, otherwise the cable may inadvertently apply the trailer brakes and this could cause damage to the brake components.

Remember to check the breakaway cable for any signs of damage. The cable is designed to apply the trailer brakes and then snap once the brakes are applied so any damage may result in premature failure and the brakes not being properly applied.

And ... remember ... Many inadvertent detachments occur at low speed - normally as a result of the hitch head not being engaged properly onto the tow ball assembly. A low speed detachment may not result in the breakaway cable operating properly - so ALWAYS check that the head is fully secure before setting off.



TOWING AND DRIVING

REVERSING

It is advisable to have a second person assisting when reversing the caravan.

Start practising by choosing a left-hand bend for ease. Reverse slowly; turning the wheel, initially the opposite way to the direction you want the caravan to go.

Now the front of the caravan is nudged out and is moving the rear in the intended direction. Take care not to hit the caravan with the car!

Midways through the manoeuvre, when the caravan is correctly angled, reduce speed to a crawl and gradually apply opposite lock. Make the car follow the caravan round then finally straighten up.

Please note: Proficiency at reversing can only be achieved with practice.

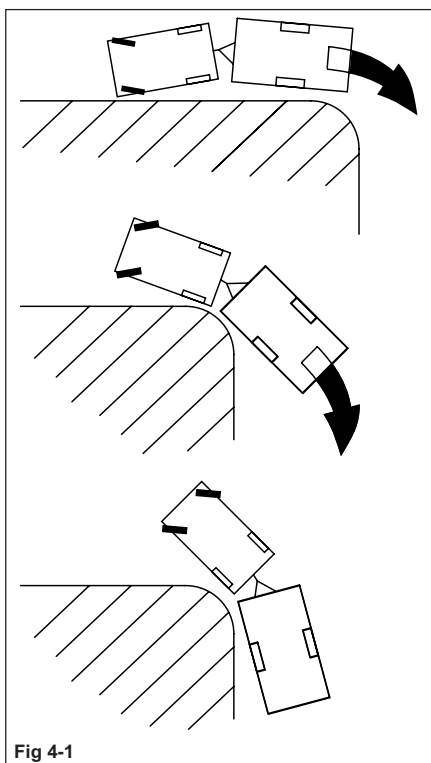

Fig 4-1

SPEED LIMITS

- Always adhere to the speed limits in force.
- When national speed limits apply, when towing on a single carriageway, the speed limit is reduced to 50mph. Dual carriageway and motorways, the speed limit is reduced to 60mph.

SETTING OFF

- (i) Pull away smoothly in the towing vehicle. Allow more engine speed to produce the power to move the additional weight of the caravan.
- (ii) Avoid wear and tear on the clutch and transmission by taking extra care not to 'ride' the clutch.
- (iii) Change gears smoothly. Try not to jerk the clutch.

CARAVAN HANDLING

- (i) Ensure you have an adequate view of the road behind you. You must fit towing mirrors if your caravan is wider than the rear of your tow vehicle.
- (ii) Give yourself more room when cornering to ensure your caravan wheels do not strike the kerb.
- (iii) When passing other vehicles, allow more than the normal clearance for driving solo.
- (iv) Allow longer to obtain a fast enough speed to pass other vehicles.
- (v) Allow for the vehicle being twice its normal length. Do not suddenly swing out.
- (vi) Carry out all manoeuvres as smoothly as possible.
- (vii) Use the wing mirror to check the caravan has clearly passed other road users when overtaking and changing lanes.
- (viii) Adverse weather conditions may affect the steering and braking characteristics of your caravan.



MOTORWAY DRIVING

Important Points:

1. Caravans may not be towed in the outside lane of a three or four lane motorway.
2. Reduce speed:
 - a) In high or cross winds
 - b) Downhill
 - c) In poor visibility
3. High sided vehicles cause air buffeting, so extra care must be taken when passing or being passed. As much space as possible should be given to avoid the drag created by the high sided vehicle.
4. When going uphill, change gear in good time. If your car is running short of power or is behind a slower vehicle, keep well into the nearside and out of the way of other vehicles. Remember that some hills can be ascended with relative ease often pose an unexpected challenge if you come to a standstill in traffic and then have to re-start from scratch.
5. When going downhill, take extra care to ensure you do not gain speed. This can be avoided by changing down a gear and reducing speed as you approach the slope. Don't leave this gear change too late. Using low gears throughout the descent will reduce the strain on the car's brakes. For automatics, you may need to manually change to a lower gear in anticipation of the effect caused by the gradient change.

TOWING COVERS

We do not recommend that you tow with covers on as they can obscure the road lights fitted.

Tyre and wheel checks

Tyres are an essential part of the safe use of your caravan and it is important that they are properly maintained to make sure that they do what they are intended to do - carry the load and grip the road as well as bringing you and your caravan to a safe stop.

So how do we know we have the correct tyres for our caravan and how do we know that they are still safe to use?

When your caravan was first manufactured the tyres fitted were chosen because they would carry the load that the caravan was designed to carry.

Note that it may be possible to increase the maximum technically permissible laden mass (MTPLM) of the caravan depending on the capacity of the chassis but it is essential that the tyres are checked to verify that they are suitable for the extra loading if this option is taken. If their loading capacity is less than the rating necessary for the increased MTPLM, they will need to be replaced.

Detailed information on the load and speed rating is marked on the side of the tyre.

Looking at the tyre not only tells us that they are the right ones for the leisure vehicle, it also tells us how old the tyre is. It is strongly recommended that tyres are renewed when they are five years old and certainly by seven years. The tyre data is only shown on one side, so it may be necessary to check the information on the hidden side.

It is unlikely that caravan tyres will wear out before they reach the end of their recommended life, but all tyres deteriorate over time due to the effects of ultra-violet radiation and atmospheric ozone, so whilst the tyre may still seem to be in good condition with plenty of tread wear left, there is an increased risk of sudden failure and they need to be changed due to ageing.

Many of the tyres checked out on the road in Police checks are in a dangerous condition and using tyres like this increases the potential for a tyre failure / blow out or other incident and could result in a fine and penalty points being added to your licence.

Check your tyres for cuts / lumps, crazing and cracks as well as wear (both on the outside and inside walls) - don't forget to check the pressures when the tyres are cold.

For further information about tyres see www.tyresafe.org/tyre-safety/caravan-tyre-safety



ARRIVING ON SITE

CHECK SITE REGULATIONS

On arrival at a site, you should always check the site regulations. This will help avoid any unnecessary conflict with site management and other site users.

WARNING: Care has to be taken to prevent grounding when traversing ramps or other ground obstacles.

SELECTING A PITCH

Carefully select where you wish to place your caravan. The site should be as level as possible, preferably not under or near trees, well drained and away from possible boggy areas. Consider how you will move the caravan when it is time to leave the site. On sloping ground it is better to pitch facing downhill, especially during wet weather.

SIDE-TO-SIDE LEVELLING

A quick glance at your pitch should tell you if you are likely to need side to side levelling i.e. levelling across the axle. On uneven ground lateral levelling is accomplished by the use of a leveller jack or ramp and a spirit level placed 'across' the caravan floor (not supplied).

Leveller Jack

Place the leveller jack, folded flat, in front of the wheel needed to be raised to level the axle. Tow the caravan onto the leveller jack and adjust the height until the spirit level shows that the caravan is laterally level.

Ramp

- (i) Reverse onto your pitch about 30cm (12") further back than you wish to end up.
- (ii) Then place the levelling ramp in front of the wheel that needs to be raised.
- (iii) Place a spirit level parallel to the axle on the A-frame or just inside the caravan door.

It helps to have two people at this point. One should drive the car very slowly forward moving the caravan wheel up the ramp, and the other should indicate when the spirit level bubble is in the middle.

Whichever method you use, and once level:

- (i) Apply the caravan handbrake and chock the caravan wheel if necessary.
- (ii) Lower the jockey wheel to ground level before unhitching. (See index uncoupling)
- (iii) If necessary use a load spreader, such as a big foot or alternative suitable device.

You should then park your car, usually next to the caravan furthest away from the door side.

Please note: On upward facing pitches when the hydraulically damped drawbar of the hitch becomes fully extended, it will be necessary to compress the drawbar slightly in order to achieve unhitching. With the caravan brake on, reverse the towing vehicle about 2.54cm (1") to release hitch lock tension and using the jockey wheel adjustment, unhitch the caravan as previously described.

FRONT & BACK LEVELLING

This should be done only when the lateral levelling is complete.

- (i) Place the spirit level pointing front to back just inside the caravan door or on the A frame.
- (ii) Then raise or lower the jockey wheel until the caravan is horizontally level.

Please note: If there is a significant front to back slope, you may need to place a block under the jockey wheel.

- (iii) Next, wind down the corner steadies onto load spreaders (blocks of wood a minimum of 15.25cm (6") square or 'Big Foot' steady attachments) until they are firmly set against the ground.

Please note: It is possible on very uneven sites that when fully extended blocks may be required under the corner steadies to achieve this. It is important that the caravan is correctly levelled to ensure the correct working of the refrigerator, cooker etc.

- (iv) Now that your caravan is level, place the caravan step in front of the door ensuring that it is stable and safe to use.



Compass

ARRIVING ON SITE



PARKING ON A REVERSE-SLOPING SITE OR STEEP HILL

For successful parking on a reverse slope or steep hill, the operator need only apply the handbrake with one hand while gently but purposely inching the caravan a small distance backwards with the other.

CAUTION: Never enter the caravan without first lowering the four corner steadies with the brace provided. Corner steadies should not be used as a jack. Take care not to lift the caravan wheels.

ENTERING AND EXITING THE CARAVAN

Due to the height to the entrance door, it is strongly recommended that you use a step to enter and exit your caravan. A suitable step is provided with your caravan and can be found within your kit box. Please ensure your step is placed in front of the entrance door and is on sound and level ground before use.



GETTING STARTED

You have arrived at your destination and now want to start to enjoy your new caravan. The following is a step by step guide to connecting your services and getting everything in your caravan working.

ELECTRICITY

Power Supply Charger

Your caravan is fitted with a power supply/charger. This will charge the leisure battery "where supplied" when fitted and also power the 12V systems.

A leisure battery must be fitted to the caravan at all times when in use.

12v Systems:

When connected to the 230Vac site supply the automatic power supply/charger will charge the leisure battery and power the 12Vdc system*

Note: the power supply protection device must be in the on position.

When connecting to the tow vehicle ensure that the mains supply has been disconnected, the 12Vdc supply will automatically switch to use the tow vehicle's supply.

When connected to the tow vehicle and the engine is running 12Vdc power is disconnected to the habitational area except for selected items and appliances, these include the 12Vdc fridge supply and charging of the leisure battery.

GENERATOR/CHARGER

When connecting to a generator, always switch off the RCD (residual current device), start the generator and allow running for a few minutes to stabilise. When this has happened, switch the RCD to the ON position.

ELECTRICITY MAINS SUPPLY

Your caravan's main electrical installation is designed to run on 230V at 50 hertz AC supply.

CONNECTING TO MAINS SUPPLY ON ARRIVAL AT SITE

Before connecting the caravan installation to the mains supply, check that:

- (i) The mains supply is suitable for your installation and appliances, i.e. whether it is AC or DC and whether it is at the correct voltage and frequency.
- (ii) Your caravan is properly earthed. Never accept a supply from a socket outlet or plug having only two pins, or from a lighting outlet.
- (iii) Any residual current device (earth leakage circuit breaker) in the mains supply to the caravan has been tested. In case of doubt, consult the site owner or their agent.
- (iv) Make sure that the switch at the site supply point is off and that all electrical equipment in the caravan is switched off by ensuring your caravan mains isolating switch on the MCB (miniature circuit breaker) is in the 'OFF' position.

ELECTRICAL WARNING

Attention: Always disconnect the electrical connector between the towing vehicle and the caravan before connecting a mains electric supply to the caravan and before charging the caravan battery by any other means.

Once the above checks have been made:

- (v) Open the battery box on your caravan and insert the female connector of the mains connection cable supplied with your caravan into the inlet within the battery box as shown below.

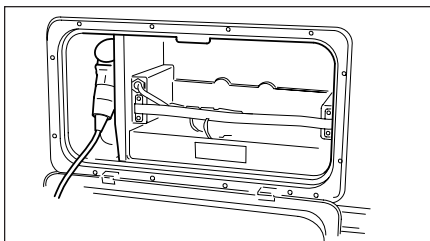

- (vi) Locate the site supply and remove any cover from the socket outlet provided at the supply point. Insert the male plug at



WIRING OF CONNECTING CABLE AND CARAVAN MAINS INLET

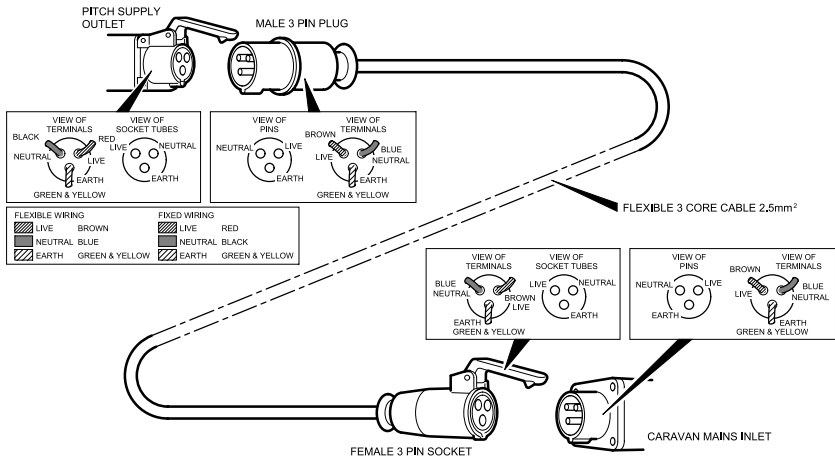

WARNING: It is essential that connections are made exactly as shown. If terminal markings are not in accordance with the above diagram they must be ignored.

- (vii) Place any surplus cable under the caravan. Ensure that the surplus cable is not coiled up as it could overheat.
- (viii) Now switch on the mains isolating switch within the caravan, this can be found on the main consumer board, normally located within a bunk.
- (ix) Check the RCD is working by pressing the test button. The 12V system must be switched off before carrying out this process. Once pressed all electrical lights and appliances should cease to operate. Reset, and then check the electrical system is operational.
- (x) Finally in order to get your 12V system operational, ensure the 12V switch is in the 'ON' position. Refer to index for further details on the control panel fitted.

- (iii) Disconnect the female 3 pin plug from the caravan and store the cable in an appropriate locker.

OVERSEAS ELECTRICAL CONNECTION

Please note: Connection to a mains voltage supply outside OVERSEAS requires particular attention.

Care must be taken when connecting supplies abroad since the supplies can be of REVERSE POLARITY.

The significance of REVERSE POLARITY is that when equipment is switched off, it may not be electrically isolated. The only certain way of making equipment safe is to unplug it.

A means of checking the polarity of the mains supply when overseas is recommended.

There are available several proprietary makes of equipment for the purpose.

If it can be achieved, it is preferable to connect live to live, and neutral to neutral to maintain full electrical protection.

CHECK all caravan equipment is set-up to accept the site supply before actually switching on.

DISCONNECTING MAINS SUPPLY WHEN LEAVING SITE

- (i) Switch 'OFF' the RDC in the caravans distribution unit.
- (ii) Remove the male 3 pin plug from the site supply.



GAS SAFETY ADVICE

The gas system within your vehicle has been installed by an STGW approved installer and tested in line with BS EN 1949:2011+A1:2013.

In the event of a suspected gas leak the gas must be turned off using the isolation valve on the gas bottle. A competent gas fitter should then check the system before it is used/reused.

Regularly check flexible gas hose, joints and connections for tightness. Finally, make sure that each gas appliance is working efficiently to the recommendations of the appliance manufacturers.

See Index - Ventilation

FACTS ABOUT LPG

- LPG is not poisonous.
- Bi-products of incomplete combustion are harmful to health.
- LPG is dangerous if all air and oxygen is excluded.
- LPG has been given a smell by the manufacturers in order to identify leaks.
- The gas is heavier than air and therefore sinks to the lowest point.

AWNING SPACES, LPG AND APPLIANCE EXHAUST

Using a refrigerator on gas which vents into an enclosed awning space must only be done if there is sufficient ventilation to prevent the build up of CO₂.

Space & Water heaters may produce sufficient amounts of CO₂ to pollute the awning space. If an awning enclosure is attached these appliances must not be used on gas.

Please note: Ventilation holes must be clear at all times.

LPG GAS SYSTEM

Elddis do not recommend the use of any external cylinders. All cylinders in use should be within the gas locker provided.

Please ensure that you have read the operating instructions for each gas appliance contained in your Owners Information Pack. Please ensure that any gas hose left unconnected is protected from dirt or other foreign bodies entering the hose.

WARNINGS

- **Fresh air circulation should be allowed below the caravan when appliances are in use and when flues terminate below the floor to allow free evacuation of the products of combustion. At least three sides of the underfloor space should always be kept open and unobstructed especially by snow. Do not make any additional openings in the floor.**
- **No appliance shall be used outside when connected to an internal outlet.**
- **Maintain adequate spacing of combustible materials from sources of heat or naked flame.**
- **Do not use additional independent gas appliances inside the caravan.**



GAS SUPPLY





Your caravan is designed to operate using either propane or butane liquefied petroleum gas at 30M/bar. Gas can be obtained from your caravan dealer. Your caravan is designed to accept a maximum 2 x 6-7kg gas bottles.

Connection

Make sure that heating and cooking appliances and gas cylinders are switched off.

Each gas appliance is connected to its own gas isolation tap. These are identified on the tap via a label. Below is a key to identify each label.

To operate the tap the arrow on the tap shows the direction of flow for the gas.

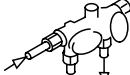
 Water Heater	 Cooking Appliance
 Space Heater	 Hob
 Refrigerator	 Gas On/Off

Changing a Gas Cylinder

Before commencing to change a gas cylinder ensure that the valve on the cylinder is turned fully off. Turn off all gas operated appliances.

Remove the gas hose from gas cylinder.

Before refitting a gas cylinder, ensure that all gas operated appliances are turned off - particularly after winterisation. Ensure all connections are secure.

When the cylinder is connected please ensure that the high pressure hose is not placed under any strain.

WARNING: If cylinders other than those recommended are used, ensure that the cylinders are adequately supported, do not block ventilation openings and care to be taken not to cause damage to fixtures and fittings located in the compartment.



Auto Changeover Gas Regulator

The Whale Auto Changeover Gas Regulator, Type 924N has been specially designed to supply a caravan or motorhome gas installation in compliance with the requirements of annex D of standard EN 12864. Supply pressure for appliances is standardised at 30 mbar for the whole of Europe.

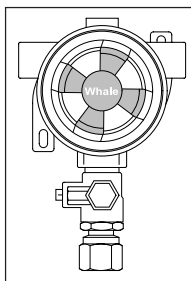

Note: Not suitable for use in caravans or motorhomes when the vehicle is in transit.

WARNING: This product is designed for use with all liquefied petroleum gases: propane, butane and LPG.

LPG is highly flammable.

Important: In the following cases, shut off the cock on the cylinder **IMMEDIATELY** and contact your dealer or Whale Support +44 (0)845 217 2933:

- Abnormal combustion at the burner(s) of a gas appliance (flames too high or too low)
- Smell of gas
- Outbreak of fire

A planned maintenance schedule of regular inspection is recommended, replacing components as necessary.

We recommend the gas regulator unit be replaced 10 years from the date of manufacture.

Instructions for use

The two inlets of the regulator are to be connected by means of two high pressure hoses complying with the specifications of Standard EN1949.

Putting into <<service>> Figure 1.

- After having checked that the indicator remains green in the two positions of the knob, turn the knob so that the arrow is facing to the right or the left. The arrow on the knob will indicate the cylinder in <<service>> use.

Operation of the <<reserve>> Figure 2.

- The indicator is red which means that the cylinder in <<service>> has run out. It is now empty and the installation is operating on the <<reserve>> cylinder.

Replacing the empty cylinder, Figure 3.

- Turn the knob halfway. The cylinder that was previously in <<reserve>> will become the cylinder in <<service>> the indicator will turn green as usual. If it stays red, this means the system has been operating on the <<reserve>> cylinder for too long and that this one is also empty. It will therefore be necessary to change both cylinders.

CAUTION: It is strongly recommended that only Gas Safe Register™ or STGW approved gas fitters carry out any work on your caravan gas installation.

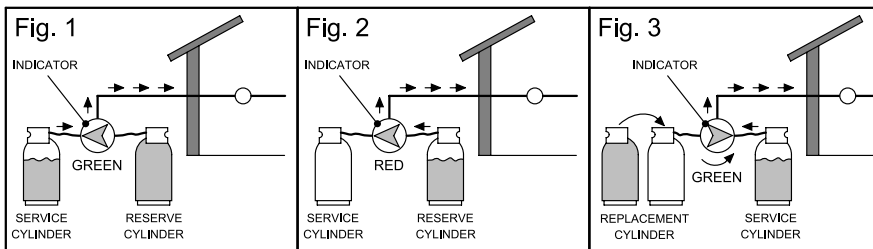



High Pressure Gas Hoses

You should only connect to this regulator using a length of approved high-pressure hose not exceeding 450mm from the gas cylinder to the regulator. These approved high-pressure hoses are available from your Elddis Retailer. These hoses are connected using screw thread fittings, which will make a seal if connected and tightened using a spanner. Once the hose is securely connected turn on the gas tap above the regulator, then turn on the gas bottle to allow gas to flow into the caravan.

In order to make all your caravan gas appliances operational it is necessary to open each appliance gas tap as detailed in previous column. All your gas appliances should now be operational. Instructions on how to use each appliance are detailed later in your handbook.

WARNING: Aerosols and highly flammable liquids must not be stored in the compartment behind, or adjacent to, any gas appliance. Some industrial LPG appliances operate at high pressure and require a 'high pressure' regulator. This often has an adjusting handle on it. NEVER use such a regulator on a caravan. Ventilation holes must be clear at all times.



Whale High Flow Pump with Intelligent Control®

Your caravan has been fitted with the Whale High Flow Pump with Intelligent Control®

Water System

Before using your water system for the first time, you must prime the water system and calibrate the Watermaster Pump Controller. Your water system has been fitted with the technology to ensure you never have to adjust your pressure switch again! Whale High Flow Pump with Intelligent Control® also protects the life of your pump by automatically turning it off if the water container is empty.

To prime your Water System

Step One

Place pump into a full water container.

Ensure that the pump reaches the bottom of the water container as shown.

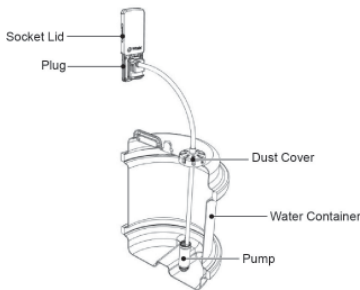

Step Two

Open socket lid, by using the side grips as shown.

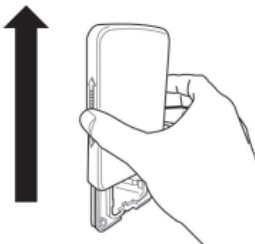

Step Three

Insert plug and secure by using the socket lid to lock in place.

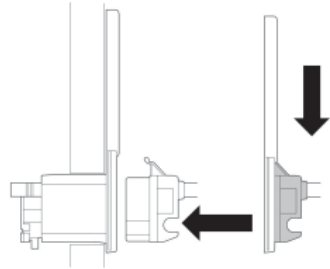

Step Four

Adjust the dust cover so that it covers the opening in the water container. This prevents debris entering. **Please Note:** The dust cover **must not** be secured to the opening as air **must** be able to enter the container.

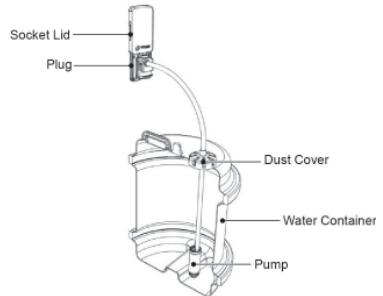

Step Five

Switch on the Master Switch. This allows 12V d.c. to reach the pump and it should start to run.

Step Six

Open one cold tap. Trapped air will be expelled from the system and water will flow from the tap. Open all taps on cold then hot to expel all air in the system.

Step Seven

Turn the tap off when water flows evenly. The pump should turn off after approximately 10 seconds.



To calibrate the Water System

Now that the water system has been primed, you must calibrate the Intelligent Control® unit, which is located at the back of the water socket (inside the caravan).

5 easy steps to calibrate your Watermaster® IC Pump Controller

To ensure successful installation and optimum performance of the Watermaster® IC Unit, please follow these 5 simple steps. You must calibrate the system.

Step 1
Press and hold the calibration button until the green LED starts to flash after 1-3 seconds



Step 2
Open the cold shower and the pump should start (there may be a short delay)



Step 3
After approximately 30 seconds, turn off the shower



Step 4
After approximately 10 seconds (the pump should still be running), press and hold the calibration button again until the LED turns solid green and the pump will stop after approximately 10 seconds



Step 5
The green LED should turn off and blink briefly every 5 seconds. The system is now calibrated

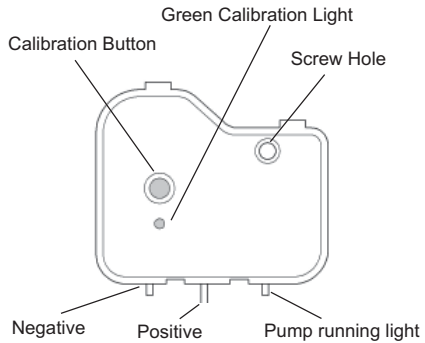
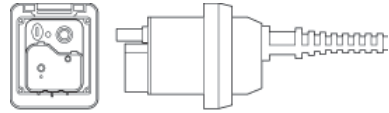

Watermaster® IC

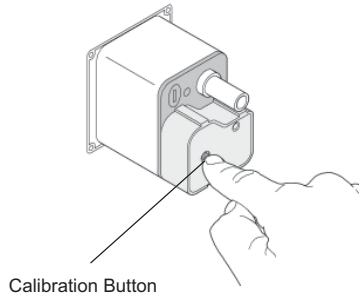

Calibration Button

Watermaster® IC is now installed and ready for use

During normal use, once calibrated you will only need to recalibrate if you use a different pump. Simply repeat the steps above to calibrate a new pump.



Water System - Diagnostics

To aid with trouble shooting the green LED on the Intelligent Control® unit will flash to indicate different fault types.

LED	Code
On	Tap open and pump running
Fast Flash (flash every 1 second or less)	In Calibration Mode
5 Second Flash (flash every 5 seconds)	Calibrated and ready for use Normal operation
10 Second Flash (flash every 10 seconds)	Un-calibrated. Follow calibration instructions
15 Second Flash (flash every 15 seconds)	Water container is empty. Turn Master Switch 'off' then 'on' again
20 Second Flash (flash every 20 seconds)	Battery voltage is low. Turn Master Switch 'off' then 'on' again and charge battery

Water System - Troubleshooting

Problem	Solution
Pump will not run	Check at least one tap is open
	Turn the pump isolator switch 'off' then 'on' again
	Check the battery is fully charged
	Check the pump isolator switch is 'on'
	Check the master switch is 'on'
	Clean the electric contact strips on either side of the plug and ensure they are making contact with the socket
	Check wiring connections
Pump cycles on and off with all taps and showers are closed	Check fuse (see fuse box)
	Check for air or water leaks in taps and piping
	Check the non-return valve (fitted in the socket) is free from grit and dirt. Use a ballpoint pen to dislodge any grit in the non-return valve
Pump runs for 30 seconds or more without stopping when all taps and showers are closed	Recalibrate the system - follow calibration instructions
	Check all connections in the pipework are secure
	Recalibrate the system - follow calibration instructions.



Storing Your Water Pump

The socket lid **must be** closed while not in use.

The pump **must be** removed from the socket before moving the caravan.

The pump **must be** stored in a cool, dry place when not in use.

When refilling your water container, the pump can be placed as shown to keep it clean.



For efficient running and maximum pump life:

- Ensure there is sufficient water in the container.
- Ensure continuous operation does not exceed 15 minutes.
- Ensure all pipework connections are secure and watertight.
- Ensure the power supply is adequate.
- Keep o-rings well lubricated to aid connection and removal of the plug. Use a water-based lubricant such as silicone grease. Vaseline **must not** be used.
- Clean electric contact strips often.
- Shake pump to expel air before dropping it into the water container and connecting the plug.



Water System - Maintenance

Whale Watermaster Pump with Intelligent Control® is designed to be maintenance free and does not contain any serviceable parts. Please note: The Intelligent Control unit is enclosed to protect the electronics and must not be opened. Opening the unit will result in damage and may invalidate your warranty.

Whale recommends a regular schedule of inspection, at least twice a season.

Water System - Replacement Parts

Part Number	Description
GP1652	Whale High Flow Pump Only
EP1612	Whale High Flow Pump and Plug
EP1612	Whale Watermaster IC® Kit - includes High Flow Pump and Plug and IC Unit

Water System - Winterising

Your water system must be drained fully when not in use. For details of how to drain your water system in preparation for winter storage see The Whale Guide, titled Getting Ready for the Winter..

Water System - Support

For installation advice or help with your water system please contact Whale Support.

Tel: +44 (0)28 9127 0531

E-mail: info@whalepumps.com



ELECTRICAL SYSTEM

12v POWER SUPPLY

Battery Installation

Your caravan will be fitted with a BCA Leisure charging and power distribution unit.

If you wish to install a leisure battery please ensure that it is placed on the battery tray supplied with your caravan. Then place the tray in the battery locker fitted to the side of your caravan. Connect the battery to the clamp fittings connected to the connection leads within the battery box.

The type of leisure battery you should utilise will depend on how you wish to use your new caravan. We recommend that you refer to the NCC approved battery scheme, which can be found at www.thencc.org.uk.

Battery Maintenance

Storage

Ensure that the leisure battery is fully charged before placing the vehicle into storage.

Once in storage disconnect the battery. Check the battery state every 2 months, if the terminal voltage drops below 12.07V then re-charging is necessary.

Charging should be carried out in a cool, dry, well ventilated area.

Do not place the battery onto cold surfaces such as concrete as this will affect the battery's ability to charge.

This will depend on your leisure battery's capacity, age and state of charge.

Points to remember

- Prolonged discharge causes harmful sulfation and may damage a battery.
- For peak performance never let a battery sit discharged for long periods of time.
- Over discharged batteries are permanently damaged and need to be replaced.

Note: Do not over discharge the battery. One of the most common causes of battery failure is when the battery is discharged below the recommended level of approximately 12.2v -

ref table. Discharging a battery below this figure will cause permanent damage. Overheating and gassing will occur when re-connected to the mains supply.

	12 Volt Battery	State of Charge
Good	12.7V	100%
	12.5V	90%
OK	12.42V	80%
	12.32V	70%
	12.20V	60%
	12.06V	50%
Warning	11.9V	40%
	11.75V	30%
	11.58V	20%
Damaged	11.31V	10%
	10.5V	0%

Good: the battery is in good condition and not in need of charging

OK: nothing to worry about but put the battery on charge as soon as you can

Warning: get the battery on charge as soon as you can. Leave it and the battery will be damaged, possibly beyond repair

Damaged: Replace battery

Generators / Charger

All electrical equipment fitted in your new caravan can be run from either a controlled generator or charger whose output is maintained between 11volts and 14volts.

At least once every 3 years, the caravan electrical installation should be inspected and tested, and a report on its condition obtained, as prescribed in British Standard BS7671.



230v POWER SUPPLY

Mains Unit

The Mains Unit replaces the conventional fuse box. Similar, but larger ones are often fitted in new houses. The unit, normally located in the front bed box, gives overloads and earth leakage protection for the 230V electrical supply in your caravan.

For normal operation all switches on the unit need to be in the ON position. The switches on the left of the unit are known as MCB's (miniature circuit breakers). These take the place of the conventional fuse but are more convenient. In the event of a fault the MCB 'trips' i.e. automatically moves to the OFF position. After elimination of the fault the MCB can be re-set by switching to the ON position (against the spring pressure in an upwards direction). If an earth fault develops, or a person was to touch a live piece of equipment, the leakage of current to earth should immediately operate the RCD (residual current device) and 'trip' the main switch, to the OFF position. This switch can only be re-set after elimination of **the fault**.

Please note: In case of difficulty, consult an approved electrical installation contractor (who may be the local electricity board). It is dangerous to attempt modifications and additions yourself. Lamp holder-plugs (bayonet- cap adaptors) should not be used under any circumstances.

Resetting the RCD

To re-set, operate the switch as for MCB's. Periodically, the RCD should be checked by operating the test button marked 'T'. The unit should immediately switch to the OFF position. If the unit does not switch off then a qualified electrician should be consulted. If the unit does switch off, the test is complete and the switch can be re-set restoring the supply back to normal.

Please note: Simultaneous operation of all of the 230V mains electrical equipment may not be possible. A typical UK caravan site mains hook-up point provides a maximum output of 16 amps and on some continental sites the available output may be as low as 5 amps. If your loading exceeds the site supply it may trip the site circuit breaker. Please check the

available mains output with your site operator. The following items need to be added together if used simultaneously.

230V mains equipment typical consumption figures:

- Refrigerator 0.50 amps
- Charger 2.2 amps
- Combi heaters 13 amps
- Colour TV 3.33 amps
- Microwave 4.00 amps

AUTOMATIC CHARGING SYSTEM

The battery charger will operate automatically when the caravan is connected to the mains outlet on a caravan site. The 12V system, with the exception of the 12V refrigerator and battery charging, will not operate when the caravan is connected to the towing vehicle.

CHECK all caravan equipment is set-up to accept the site supply before actually switching on.

INTERNAL LIGHTS

Your new caravan is fitted with all LED lighting.

MAXIMUM POWER RATINGS FOR INTERNAL LIGHTS

Type of Light	Maximum Power Rating
Front window light	4 watts
Downlighters	1.2 watts
Reading lights	1.2 watts
Floor LED	0.36 watts
Above locker strip lights 500mm	1.2 watts
Above locker strip lights 800mm	2.2 watts
Awning lights	5 watts

LED tape is used as backlit mood lighting. The wattage varies from 4.8 to 9.6W depending on the location within the vehicle.

Please note: All LED units must be replaced with like for like or manufacturers recommended replacement.

Never replace an LED with one which has a higher rating.

CAUTION: Do not look directly at LED lights.



Compass

ELECTRICAL SYSTEM



Connecting a Solar Panel and/or Satellite Dish (Option only)

If you ordered your caravan with the entertainment pack option fitted then your caravan will have both a solar panel connection point and a satellite TV connection point within the battery box.

External Solar Panel Connection

To connect a solar panel insert the panel connection lead into the connection point within the battery box, please ensure that you have a regulator in line whenever a solar panel is connected.

External Satellite TV Connection

To connect a Satellite TV receiver simply insert the satellite connection into the connection point within the battery box and this will feed the satellite signal to the TV outlets within your caravan. You will need to fit the satellite decoder between the aerial outlet and your TV.



MAINS UNIT

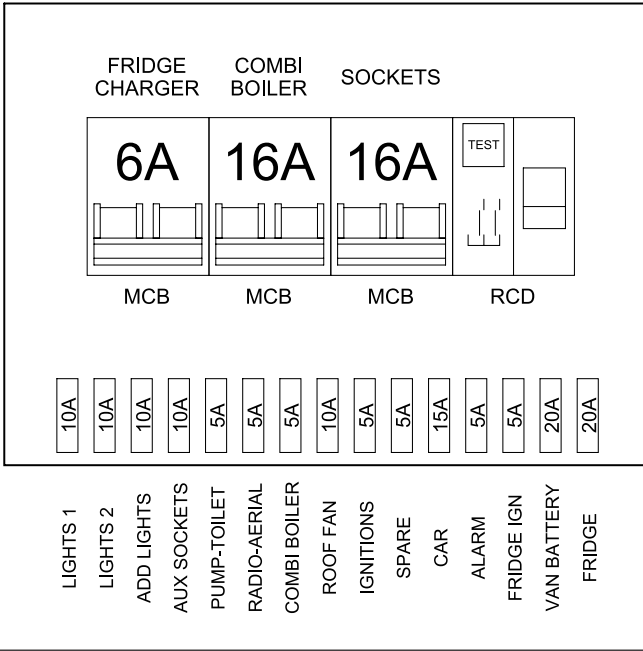

HOW TO USE YOUR CARAVAN'S EQUIPMENT

Within this section of your caravan's handbook we will give you brief details on how to operate all of the caravan's equipment from the gas cooking equipment to the window blinds. For further details on the major equipment within your caravan please read the individual appliance instructions contained with your user information pack.

Please note: Before attempting to use any gas equipment please ensure that the gas bottle is connected securely to the caravan's regulator via a high pressure gas hose and the bottle valve is in the 'on' position. Also ensure the appliance isolation valves are in the 'on' position as shown in the gas system section.

Please note: Before attempting to use any electrical appliance ensure that you have connected the mains connection cable to a mains hook up and that the mains isolation switch is in the 'on' position.

ELECTRICAL CONTROL PANELS

Camino

Your new Caravan will be fitted with the following control panel.

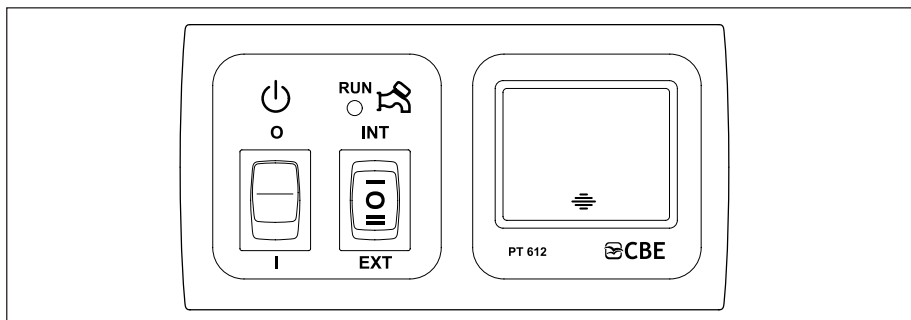

- (i) To operate the 12V systems for your caravan depress the master switch adjacent to the pump control switches.
- (ii) To operate the pump for your water system depress the left hand rocker switch for operation from an external water source. (Aqua roll or Water line).
Note: the right hand switch must be in the centre position.
- (iii) To fill on the onboard water tank the left hand rocker switch must remain in the on position then depress the right hand rocker switch to the EXT position. Once the tank is full the pump will automatically switch off.
- (iv) To use water from the on board water tank the left hand switch must remain in the on position then depress the right hand switch to the INT position.

Digital readout

- (v) Displays both battery voltage and onboard tank level (Note: the water level is a guide only)
To illuminate the back light, lightly touch the "touch button" once, the backlight will remain on for 15 seconds.



OVEN, HOB AND GRILL

Safety

- This appliance may be used by children aged 8 years or older and persons with reduced physical, sensory or mental capabilities and/or lack of experience and knowledge only if they are supervised or have been given instructions on the safe use of this appliance and understand the potential hazards.
- Keep children younger than 8 years away from the appliance, except under constant supervision.
- Do not allow children to play with the appliance.
- Do not allow children to clean or maintain this equipment unattended.
- Use only parts supplied by the manufacturer.
- Do not change or adjust anything on the appliance, unless the change is authorised by the manufacturer or its representative.
- If the power cord is damaged, it must be replaced by the manufacturer, its service agent or similarly qualified persons in order to avoid a hazard.
- Use the appliance for cooking only and not for anything else, for example room heating. This can lead to carbon monoxide poisoning and overheating. The manufacturer cannot be held liable for damage resulting from improper use or incorrect setting of the controls.
- This appliance is not intended to be operated by means of an external timer or separate remote-control system.
- The use of this gas cooking appliance results in the production of heat, moisture and products of combustion in the room in which it is installed. Ensure the room has sufficient ventilation when the appliance is in use. During prolonged use, additional ventilation may be needed by opening a window or increasing the extraction force of the hood.

- Never extinguish a cooking fire with water. Turn the burner off and cover the flame with a lid or a fire blanket.
- The burners and pan supports are hot during and after use. Allow all parts to cool before touching them, as this can cause serious injury.
- Unattended cooking on a hob with fat or oil can be dangerous and may result in fire. Do not leave the appliance unattended when in use.
- The use of inappropriate hob guards can cause accidents.
- Do not store items on the cooking surface of the hob.
- The food shelves and trays in the appliance are hot during and after use. Allow all parts to cool before touching them, as this can cause serious injury. Always use oven gloves when removing the shelves and trays.
- Do not store items in the appliance.
- Do not put heavy objects on the open appliance door.
- The appliance and accessible parts become hot when the grill is in use. Young children should be kept away.
- Caution: hot surfaces. Door must be open when grill is in use.

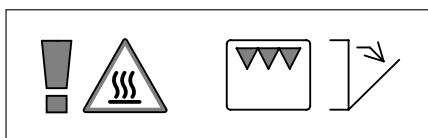

- In the event that abnormal drift in cooking temperature of the oven is observed, have the thermostat checked by a qualified service engineer.
- Care should be taken not to overload the oven, allowing adequate spacing to ensure free circulation of heat.
- Do not use steam cleaners or pressure washers to clean the appliance. See for instructions.
- Do not allow oil or fat to build up on the appliance. Clean the appliance after each use.



- **The glass lid may snap shut towards the end of lowering due to the travel-lock action of the hinges. Make sure all fingers are clear of the appliance when closing the lid.**
- **Do not use harsh abrasive cleaners or sharp metal scrapers to clean the surface of the glass, since they can scratch the glass surface which may result in shattering of the glass.**
- **Remove any spillage from the glass lid before opening the lid.**
- **Do not shut the glass lid when the burners are lit or still warm.**



- Clean the appliance with warm water and household detergent and dry carefully with a soft cloth.
- Ensure that the gas supply is connected and turned on.
- Ensure that the appliance is connected to the 12V DC battery for the spark ignition.
- Ensure that the pan supports are positioned properly.
- Ignite the gas burners and let them burn to expel odours and vapours first.
- Ignite the burner and heat the grill for about 20 minutes to eliminate any residual factory lubricants that might impart unpleasant smells to the food being cooked. Smoke may occur during this procedure. Open any windows and turn on mechanical ventilators to help remove the smoke.
- Ignite the burner and heat the oven for about 30 minutes at 200°C to eliminate any residual factory lubricants that might impart unpleasant smells to cooked food. Smoke may occur during this procedure. Open any windows and turn on mechanical ventilators to help remove the smoke.

Dual Fuel only:

- Ensure the electricity is connected and switched on.
- Prime the hotplate by switching on the hotplate for a short period, without a pan, to harden and burn off the coating. Use a medium to high setting for 3-5 minutes. Allow adequate ventilation to disperse any smoke that occurs during this process. Allow the hotplate to cool.
- Season the hotplate by heating the hotplate for 30 seconds on a medium setting and then switching off. Pour a minimal amount of unsalted vegetable oil onto a clean dry cloth or paper towel and apply a thin coat of oil to the hotplate surface. Wipe off any excess oil, then heat the hotplate on a medium setting for 1 minute. Occasional seasoning will help to maintain the hotplate's appearance.

Only use LPG (Liquefied Petroleum Gas). The appliance operates on propane or butane. Propane is preferred over butane, because butane provides poor performance at an ambient temperature below 10°C and cannot be used at an ambient temperature below 5°C.





Use of the burners

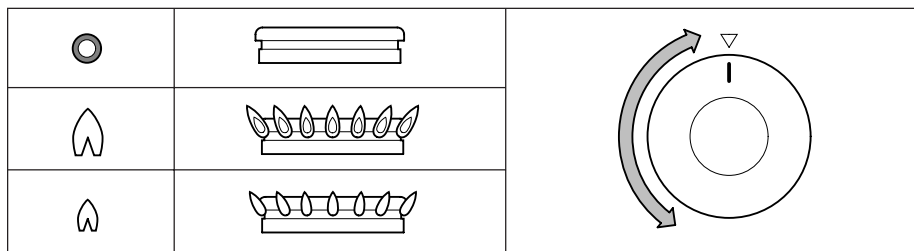

Turning on:

- Push and turn the control knob.
- Turn the control knob anti-clockwise to the full rate position.
 - For spark ignition models: Push the ignition button.
 - For non-ignition models: Hold a lit match or gas match to the burners.
- Keep the control knob pressed for about 10-15 seconds and then release it.
- Adjust the height of the flame.

If the burner accidentally extinguishes turn the control knob to the 0 position and wait at least 1 minute before re-igniting the burner.

If the burner has not lit within 15 seconds turn the control knob back to the 0 position and release it. Wait at least 1 minute and repeat the steps above to turn on the appliance.

Turning off:

- Turn the control knob clockwise to the 0 position to turn off the burner.

Always make sure the control knob is in the 0 position when you have finished using the gas burners.

Do not shut the glass lid when the burners are lit or still warm.

Use of the electric hotplate (if applicable)

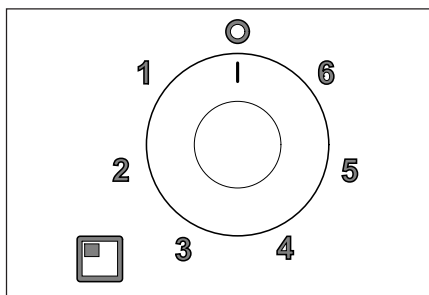

For the exact location of the control knob, see:

Turning on:

- Rotate the control knob either clockwise or anti-clockwise to the required position (1-6).

For maximum efficiency, a correctly sized pan with a flat heavy gauge base should be used. The pan size should be the same or slightly larger than the hotplate (up to 1"/2.5cm oversize).

Turning off:

- Turn the control knob to the 0 position to turn off the hotplate.

Always make sure the control knob is in the off position when you have finished using the hotplate.

Do not shut the glass lid when the hotplate is turned on or still warm.

Use of the grill

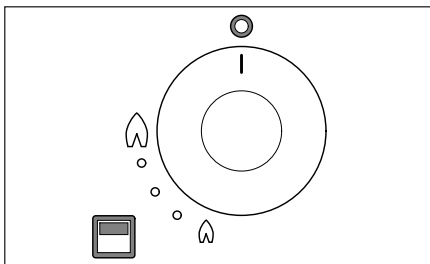

Turning on:

- Open the door and push the control knob.
- Continue pressing the control knob and turn it anti-clockwise to the full rate position.
 - For spark ignition models: Push the ignition button.
 - For non-ignition models: Hold a lit match or gas match to the burner.
- Keep the control knob pressed for about 10-15 seconds and then release it.
- Adjust the required heat setting.
- Depending on the food to be cooked, the correct grilling height can be achieved by inverting the pan trivet into either the high or low position.
- The grill pan supplied is multi-functional, for use in grill or oven and the handle design allows removal or insertion whilst the pan is in use. Always remove the handle when the pan is in use.

The grill door must remain open when lighting and using the grill.

If the burner accidentally extinguishes turn the control knob to the 0 position and release it. Wait at least 1 minute and repeat the steps above to turn on the appliance.

Although the grill heats up quickly, it is recommended that a few minutes preheat be allowed.

It is normal for the flames on this burner to develop yellow tips as the grill heats up.

Turning off:

- Turn the control knob clockwise to the 0 position to turn off the burner.



Always make sure the control knob is in the 0 position when you have finished using the grill.

Use of the oven

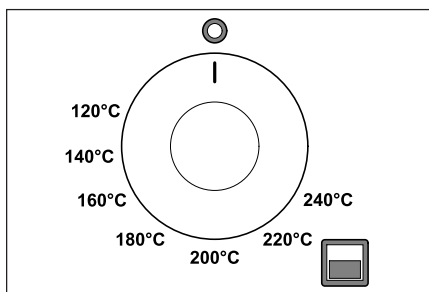

For the exact location of the control knob, see:

Turning on:

- Open the door and push in the control knob.
- Continue pressing the knob and turn it anti-clockwise to the full rate position. (240°C/240°C, gas mark 7/9).
 - For spark ignition models: Push the ignition button.
 - For non-ignition models: Hold a lit match or gas match to the burner.
- Keep the control knob pressed for about 10-15 seconds and then release it.
- Adjust the required heat setting.
- Place the oven shelf in the required position and close the door.

Ignition must always be carried out with the oven door open.

If the burner accidentally extinguishes turn the control knob to the 0 position and wait at least 1 minute before re-igniting the burner.

If the burner was not lit within 15 seconds turn the control knob back to the 0 position and release it. Wait at least 1 minute and repeat the steps above to turn on the appliance.



Although the oven heats up quickly, a 10-minute preheat is recommended. The oven should reach full temperature in about 15-20 minutes.

Turning off:

- Turn the control knob clockwise to the 0 position to turn off the burner.



Always make sure the control knob is in the 0 position when you have finished using the oven.

Safe cooking

- Do not allow cooking vessels to overlap the edges of the appliance - use the correct sizes of pans and position them centrally over the burners.
- Ensure that there is at least a 10mm gap between the pans and the edges of the hob.
- Turn the pans so that the handles do not overhang the front of the appliance.
- Ensure that the flame of the gas burner heats the bottom of the pan, not the sides.
- The pans and trays supplied with this appliance are the maximum sizes. Do not use larger pans and trays. They may restrict good circulation of heat, which may increase cooking times.
- The oven shelf allows good circulation at the rear of the oven.
- A raised bar at the rear of the shelf prevents trays or dishes making contact with the back of the oven.
- To remove a shelf, pull it forward until it stops, raise at the front and remove.
- To place a shelf in the oven, lower it at the front and slide it backward until it stops.
- Do not leave the appliance unattended when in use.
- Do not use the appliance while the vehicle is moving.
- Turn the control knob back to the 0 position after cooking.
- Keep the appliance clean and prevent accumulation of grease and food scraps.

Never cover slots or holes in the appliance and never cover a shelf with materials such as aluminium foil. That restricts the airflow and may cause carbon monoxide poisoning.



The food shelves and trays in the appliance are hot during and after use. Allow all parts to cool before touching them, as this can cause serious injury. Always use oven gloves when removing the shelves and trays.

Temperature control

The temperature in the oven is controlled by a thermostatic gas tap and is variable over the range 130°C to 240°C.

The table overleaf provides a guide to the approximate temperatures at each of the shelf positions with respect to the gas mark setting. Good use can be made of the temperature variation between the shelf positions, as several dishes requiring different temperatures may be cooked at the same time. In this way maximum benefit can be obtained from the gas used to heat the oven.

Temperature zones

Gas Mark				Dish
1/4 - 1/2	90°C	110°C	130°C	Meringues
1	110°C	130°C	150°C	Stewed fruit
2	120°C	140°C	160°C	Rich fruit cake, rice pudding
3	130°C	150°C	170°C	Baked custard, shortbread finger
4	140°C	160°C	185°C	Victoria sponge
5	155°C	180°C	200°C	Whisked sponges, ginger nuts
6	170°C	190°C	215°C	Short crust pastry
7	185°C	210°C	230°C	Bread, scones, flaky pastry
8	200°C	220°C	245°C	Puff pastry
9	215°C	240°C	260°C	Quick browning



Care should be taken not to overload the oven, allow adequate spacing to ensure free circulation of heat.



When roasting with aluminium foil ensure the foil does not impair circulation of heat or block any oven flue outlet.

Maintenance and cleaning

Thetford recommends an annual inspection service by an approved service centre. Between annual servicing, clean the appliance regularly after use. Before any cleaning work is started, the appliance should have been left to cool and be disconnected from the gas and electrical supplies.

- Always remove any spills or contamination immediately after use with soap and hot water. Towel dry the surface with a soft cloth.
- Use a non-abrasive multi-purpose cream cleaner and a nylon scourer pad to clean more stubborn dirt or grease.
- Use a proprietary stainless steel cleaner or polish to remove superficial surface scratching.
- Do not use abrasive cleaners, metal scouring pads or hard brushes. They could damage the appliance.
- If you clean the burner rings, ensure that the holes are not clogged.
- Do not use harsh abrasive cleaners or sharp metal scrapers to clean the glass surface, since they can scratch the glass surface which may result in shattering of the glass.
- Do not leave wet cloths, cleaning pads, residues of food or cleaning products or other dirt to dry on the surface. It can cause pitting, marking or even rusting.
- Always clean in the direction of the brushed finish and not across the grain.
- Cleaning agents containing bleach should not be left in contact with stainless steel.
- Mineral content in water (such as iron or lime scale) can affect the appearance of the metal.
- Remove any spillage from the glass lid before opening the lid.
- The control knobs can be removed for cleaning. The knobs are easy to replace.



Refrigerator

Operation

The refrigerator is equipped to operate on three power modes:

- **Mains voltage (230V AC)**
- **Direct-current voltage (12V DC)**
- **Gas (liquid gas propane/butane)**

Select the desired power mode by the **energy selector switch** (battery igniter type models) or the **energy selector button** (MES, AES). Appliances with automatic energy selection (AES) are additionally provided with "automatic mode" function. Then the AES system automatically selects the best energy source for each particular situation.

The cooling unit is silent in operation.

When the appliance is first put into operation, there may be a mild odour which will disappear after a few hours.

The refrigerator will take several hours to reach its operating temperature in the cooling compartment. The freezer compartment should be cold about one hour after switching on the refrigerator.

Cleaning

Before starting up the refrigerator, it is recommended that you clean it inside and repeat this at regular intervals.

Use a soft cloth and lukewarm water with a mild detergent. Then wipe out the appliance with clean water and dry thoroughly.

To avoid material alterations, do not use soap or hard, abrasive or soda-based cleaning agents. Do not allow the door seal to come into contact with oil or grease.

Maintenance

- In compliance with the applicable regulations, please note that the gas unit and the connected ventilation ducts must be checked by authorised technical personnel after first use and after every other year for compliance with the European Standard EN 1949. A test certificate has to be issued. **It is the user's responsibility to arrange this test.**
- The gas burner must be inspected and cleaned as necessary at least once a year. When using liquefied petroleum gas (tank or refill cylinders) the maintenance interval is reduced to half-yearly or quarterly. Keep the evidence of maintenance work carried out on your refrigerator.
- Work on gas and electrical equipment shall be carried out by qualified personnel only. It is recommended that this is carried out by an authorised customer care department.

We recommend maintenance following an extended shutdown of the vehicle. Please contact our customer care.

Electrical operation

12V-voltage (on-board power supply)

CAUTION: The refrigerator should only be used in 12V DC operation while the vehicle's engine is running, otherwise the on-board battery would be discharged within a few hours.

Mains power (230V)

CAUTION: This option should only be selected where the supply voltage of the connection for power supply corresponds to the value specified on the data plate. Any difference in values may result in damage to the appliance.

Manual energy selection/automatic ignition on MES:

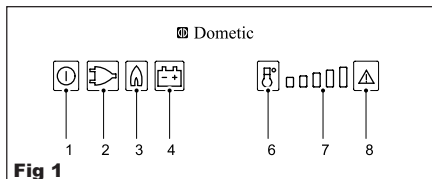

- Fig 1**
- 1 = Power ON/OFF switch
 - 2 = Energy selector button 230V ~
 - 3 = Energy selector button GAS
 - 4 = Energy selector button 12V =
 - 6 = Temperature level selection
 - 7 = Temperature level display
 - 8 = Indicator LED failure / Reset button GAS FAILURE

Switching ON/OFF

- Switch ON by pressing button (1), 2s
- Switch OFF by pressing button (1), > 2s

230V AC operation

- Select "Mains voltage" by pressing button (2)
- Set temperature step by pressing button (6)

12V DC operation (vehicle's battery)

- Select "Battery voltage" by pressing button (4)
- Set temperature step by pressing button (6)

Gas operation

- Select "Gas" by pressing button (3)
- Set temperature step by pressing button (6)

MES appliances (manual energy selection)

Electrical operation

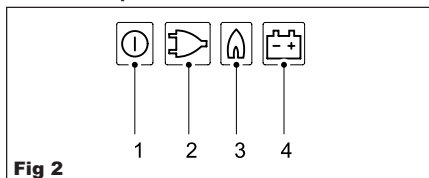

To start the refrigerator, press button (1) for 2 seconds.

The refrigerator starts with the last selected type of energy.

230V operator:

Press button (2):



12V operation:

Press button (4):



Gas operation

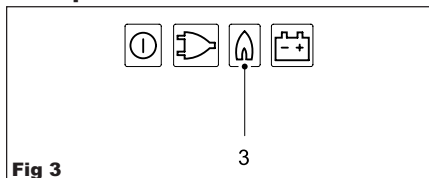

Gas operation:

Press button (3):



The ignition process is activated automatically by means of an automatic igniter.

The flame extinguishes after reaching the pre-set cooling compartment temperature and ignites again if the cooling compartment temperature increases again. If the flame is not lit after the first ignition attempt, the automatic igniter repeats the ignition twice (duration 30s) at time intervals of 2 minutes. If the flame is not lit afterwards, a fault is indicated.



Setting of cooling compartment temperature

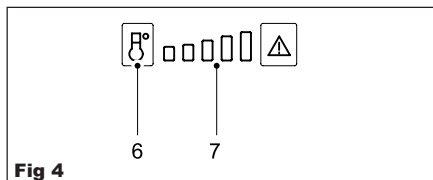

Select the desired cooling compartment temperature by pressing button (6).

The LED display (7) of the selected temperature setting is illuminated.

The scale starts with **MIN position** at the left LED position (small bar = highest temperature) and climbs up to **MAX position** at the right LED position (large bar = lowest temperature).

Note: The temperature levels do not relate to absolute temperature values.

Door locking

CAUTION: As a basic rule, shut and lock the refrigerator before you start your journey!

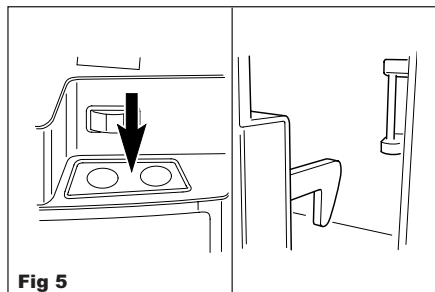

Fastening and releasing the door lock when parking the vehicle

If the vehicle is parked for a longer period of time, the locking hook may be clamped by means of a lockbar. The door may now be opened by just pulling it without need of pressing the locking button.

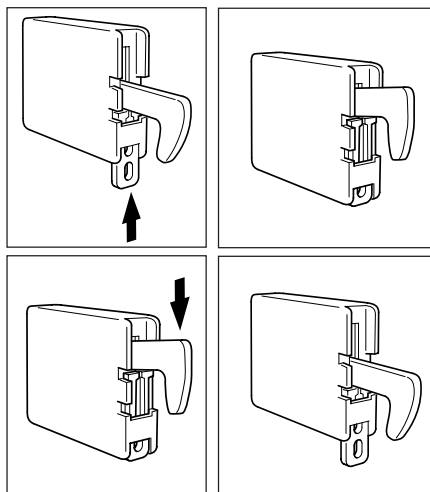

Fig 6

Open the door by pressing the locking button and pull open (Fig 6).

Shut the door again by pushing it to close. The snapping into the lock can be heard.

While the vehicle is parked, the locking hook may be fixed to facilitate opening of the door.

ALDE HEATING (3020 Control Panel)

CAUTION: Do not drink any alcohol or take any drugs before or during operating the heating system and follow the safety instructions in this manual carefully.

Turning the boiler on and off

The heating system is switched off.



The heating system is switched on.



- To start the boiler, press the On/Off button and the start-up display appears. The boiler starts with the last selected settings. A green LED comes on beside the On/Off button when the panel/heating system is on.
- To switch off the boiler, press the On/Off button.

Standby

Note: If "Background light" is set to Dark, the display goes out when it enters standby mode, but lights up if you press the screen.

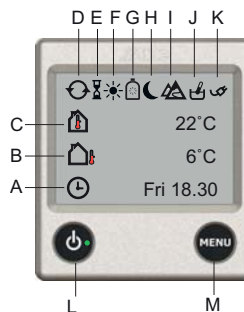

- A. Clock** The clock shows the day and time (if activated).
- B. *Outdoor temperature**
- C. Indoor temperature**
- D. Circulation pump** The symbol is displayed when the pump is in operation.
- E. Automatic start of the boiler** The symbol is displayed when the function is activated.
- F. Day mode** The symbol is displayed when the function is on and turns green when activated.
- G. *LPG bottle full/empty** The symbol is displayed when the sensor on DuoControl is connected and activated. If EisEX is installed, a snowflake is shown inside the gas bottle.
Green bottle = Bottle full
Red bottle = Bottle empty
- H. Night mode** The symbol is displayed when the function is on and turns green when activated.
- I. High altitude mode** The symbol flashes if the high altitude mode is activated.
- J.** The symbol flashes during heat up of *Alde Flow when set in more hot water mode.
- K. 230 volt** The symbol is displayed when 230V is connected to the boiler.
- L. On/Off button** Main switch for boiler.
- M. MENU button** Button for settings menu.

Functions marked with a (*) are accessories, which are not installed on all vehicles, refer to the vehicle manufacturer's instructions.



Settings Menu

Launch the settings menu by pressing the MENU button. The background light comes on and those functions that can be set are displayed. Settings that you make are automatically saved after 10 seconds. The control panel will go to standby automatically after 30 seconds if the screen has not been touched.

The control panel in standby mode

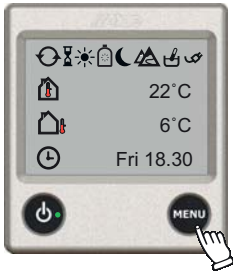

The control panel in settings menu

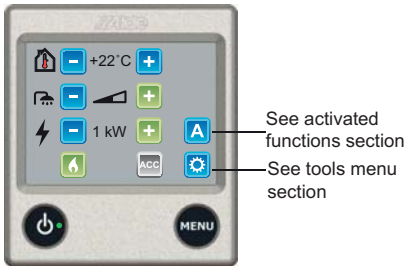

Set the Desired Temperature

The temperature can be set between +5°C and +30°C, inclusive, in increments of 0.5°C.



1. The temperature displayed is the temperature which is currently set.
2. Increase the temperature by pressing the "+" button. Reduce the temperature by pressing the "-" button.
3. The settings are now complete and the boiler will work at the set temperature.

Note: If night or day auto is activated and the time is within the scheduled period, a moon or a sun will appear beside the temp setting. The temperature set will be the one of the mode shown below:

- +22°C + [Moon icon] Night mode
- +22°C + [Sun icon] Day mode

Domestic Hot Water

The boiler is fitted with a built-in hot water boiler which can hold approximately 8.5 litres. The boiler can equally well be used without there being any fresh water in the boiler. There are three different settings for hot water: no hot water, normal operation and more hot water.

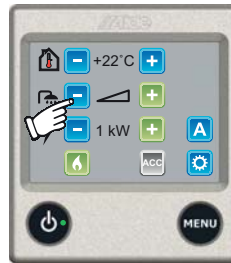

1. No hot water. If domestic hot water is not needed, press the "-" button (symbol becomes empty).

Note: If night, day or antimicrobial mode is activated and the time is within the scheduled period a moon, sun or the antimicrobial symbol will appear inside the hot water setting. The hot water setting will be the one of the mode shown below.

- [Empty triangle] + [Moon icon] Night mode
- [Empty triangle] + [Sun icon] Day mode
- [Filled triangle] + [Antimicrobial icon] Antimicrobial mode



2. Normal operation. If there is freshwater in the heater and hot water is required, press the "+" button (the symbol will then show half-shaded).

Note: If the pump operation function has been set to Cont, this option cannot be selected.

WARNING: Scalding Hazard: Since the hot water and the glycol heating fluid is heated simultaneously, the hot water can be very hot when a high level of heating is required.



3. More hot water. If you need more hot water, the water temperature can be temporarily increased to around 70°C. Press the "+" button so that the symbol shows fully shaded (black). The boiler returns to normal operation after 30 minutes.

Note: If the pump operation function is set to Cont, then the continuous pump operation function is turned off for 30 minutes, before then returning to continuous pump operation.

Note: If an additional hot water tank is installed and the panel is in more hot water mode, the hot water function can then be in operation for longer than 30 minutes.

Info: When hot water only is required, during the summer for instance, or when there is no requirement for hot water, no settings need to be made; the boiler looks after this function automatically.

Heating with Electricity

Proceed as follows to activate heating with electricity. The more power (wattage) you select, the quicker heating will take. A priority can be set when selecting both electricity and gas. The boiler uses no more power than is needed, even if it is set for 3kW.



1. Use the + or - button to switch on the electric heating and toggle between the various power modes (Off, 1kW, 2kW or 3kW). The set value will be displayed on the screen. The activated mode is indicated by the + button changing colour to green. If a *load monitor is installed and set, the boiler will not use more electricity than it is capable or even if 3kW is selected.
2. The settings are now complete and the boiler is working at the set temperature.
3. To switch off electrical operation, use the - button to toggle to Off.



Heating with Gas

Proceed as follows to activate heating with gas. A priority can be set when selecting both electricity and gas.



1. Start gas operation by pressing the LPG flame symbol. The LPG symbol is activated and changes colour to green.
2. The settings are now complete and the boiler will work at the set temperature.
3. To switch off gas operation, press the LPG flame symbol. It will now change to blue.

*Fully Automatic Climate Control (ACC)

If a Truma AC is connected to the Alde, then the ACC button is visible and it is possible to control ACC from the panel. This function makes it possible to have fully automated climate control for both heating, cooling and hot water. The button is grey if not installed or if 230V is disconnected. With an outside temperature sensor fitted, ACC function is improved: operation of the AC is modified in line with the outdoor temperature.



Figure 1

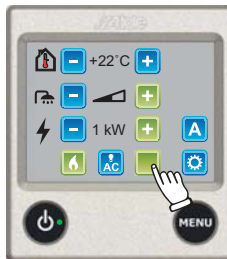

Figure 2



Figure 3

1. Set the desired temperature.
 2. Press the blue ACC button, the button turns green (see fig. 2) and the ACC function is switched on, but is not necessarily in operation. If gas and/or electricity is switched on, AC and the boiler work to deliver the temperature set, regardless of whether heat or cooling is needed in the vehicle. To turn off the ACC function, press the ACC button and it becomes blue.
- NB:** Temperature sensors that are used when fully automatic climate control is in operation must be positioned so that they are influenced equally by the heat from the Alde heating system and the air from the AC. In certain cases it can be an advantage to use Alde's temperature sensor.
3. To turn AC lighting off and on, press the button rapidly. When the button is kept pressed in, the light changes from dark to light and then back (light to dark) and so on in 8 brightness levels. When the button is released it stays at the current brightness. This button is only visible when AC* with in-built light is connected.

Activated Functions A

Activated functions (See Figure 2) can be accessed by pressing the A symbol (see Figure 1). This screen shows the various functions that are activated. The respective function that is activated can be accessed from here and new settings can be made.

Note: The A symbol is only visible if one of the functions shown below is activated and/or installed.

















Figure 1



Figure 2

Below is a description of the different symbols in the Activated Functions menu.

	Night mode is activated. However, it does not have to be within the time/day setting.		*Load monitor is connected and set to limited current.
	Automatic start of the boiler is activated. However, it does not have to be within the time setting.		*Booster is on.
	*This function is used if the heating system is to be operated via an external panel.		High altitude mode is activated.
	*Displayed if one or two external room sensors are connected.		*EisEx is installed but not necessarily turned on.
	Circulation pump in continuous operation.		*DuoControl or duoComfort is installed and connected to Alde Compact 3020 HE.
	Day mode is activated. However, it does not have to be within the time/day setting.		*Timer for engine heater is set but not necessarily within the set time/day.
	* The boiler is set to be started with External start but has not necessarily been activated.		*Underfloor heating is in operation.

Functions marked with a (*) are accessories, which are not installed on all vehicles, refer to the vehicle manufacturer's instructions.



Tools Menu

The tools menu can be accessed from the settings menu.

1. The control panel showing the settings menu. Press the tool symbol to access the tools menu.





Tools Menu - Functions

The following tools are available from the tools menu.

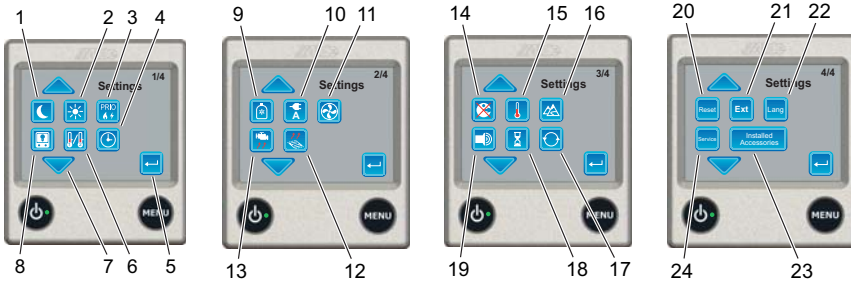





A grey function button means the function has not been installed and/or activated in "Installed Accessories".



	<p>1. Night mode Automatically changes certain functions during the night. You can select whether this is to take place every night or a specific night each week. The functions that can be changed are:</p> <ul style="list-style-type: none"> • Temperature • *Change to temperature sensor in sleeping accommodation area • Invert display • Turn off the domestic hot water • *AC in quiet mode 		<p>2. Day mode Automatically changes certain functions during the day. Select that it takes place every night or a specific day each week. The functions that can be changed during the day are:</p> <ul style="list-style-type: none"> • Temperature • Turn off the domestic hot water
--	---	---	---







Functions marked with a (*) are accessories, which are not installed on all vehicles, refer to the vehicle manufacturer's instructions.









	<p>3. Pro setting With this function you can choose to prioritise (select) electricity or gas as the main alternative.</p>		<p>4. Clock The clock must be set if engine heater start, night and/or day auto and automatic start are to work. If 12V power is lost, the clock will stop and will no longer be displayed. Installing "battery backup" will prevent this happening.</p>
	<p>5. Return To return to the previous menu, press this symbol.</p>		<p>6. *Setting room sensor Select which temperature sensor is to be active. Here you can select whether the sensor located in the daytime living area, the sleeping accommodation or in the panel is to be active. If Auto is selected, the sensor in the panel is active and will automatically switch to a room sensor (sofa and/or bed) if one of these is connected. If two room sensors are connected, it will be the one for the daytime living area that is active (sofa).</p>
	<p>7. Arrow symbols Toggle between the various tool fields by using the up/down arrow symbols. Leave the tools menu using the MENU button or the return button.</p>		<p>8. Background light The background light can be set in three different modes, Dark, Bright and Invert. Dark: Turns off background light. Press the screen or the menu button when standby is activated and the screen comes on, but returns to dark after 30 seconds if the panel is not touched. Bright: Background light in standby mode. Invert: Inverted background light in standby mode. Standby is activated automatically after 30 seconds if the panel is not touched.</p>

Functions marked with a (*) are accessories, which are not installed on all vehicles, refer to the vehicle manufacturer's instructions.



	<p>9. *EisEX, 12V defroster for gas regulator. This is a small heating element that prevents ice forming in the regulator in winter (for Mono Control CS, DuoControl CS, DuoControl and DuoComfort). If DuoControl CS or DuoControl is installed and connected, a snowflake will appear inside the gas bottle symbol when EisEX is switched on.`</p>		<p>10. *Load monitor The function prevents overload of the fuses on 230V. If the total current consumption of the vehicle exceeds the set value, the electrical output of the boiler will be reduced automatically. This also applies to Truma Comfort AC if connected to the Alde 3020. Due to voltage fluctuations and tolerances, different regulation levels can be selected (5-17A). If the fuse blows repeatedly, choose a lower setting. NB. For ACC to function with the load monitor, ACC must be on from the panel and not via the remote control.</p>
	<p>11. *Booster Control of booster in two different speeds. Fan start and stop is controlled from the boiler. If the boiler's circulation pump starts up, the fan on the booster will as well. When the circulation pump stops, the fan will continue to run for another six minutes. It will then stop unless the circulation pump has started up again.</p>		<p>12. *Under floor heating The function governs the under floor heating pump's operation in intervals, which means that the under floor heating pump is in operation for 5 min and is then off for 5 min when heat is required. Mode: Make sure Delay or Cont. is activated; in these two modes, under floor heating is switched on. In Off mode under floor heating is off. NB. In Cont. mode it can get hotter in the vehicle than desired, as the heat control is disabled! Delay: The under floor heating pump is on for a certain period after the boiler's circulation pump has stopped, this Delay can be set at 15 min, 30 min or 120 min.</p>
	<p>13. *Engine heater The function makes it possible to use the heating system to heat up the engine in a motorhome, bus etc. Engine heater start: Press the button marked Off; the text will change to On and the button will turn green. Then set the required starting time and day. Engine heating starts at the set time and day. The engine heater then runs for 60 minutes before stopping automatically. NB The clock in the panel must be set for the function to work.</p>		<p>14. Antimicrobial mode The boiler will start at 02.00 in the morning (if the clock is set) and run as indicated for "More hot water" for 30 minutes. This is to reduce the risk of legionella.</p>

	<p>15. Offset (temperature adjustment) If the temperature that is displayed in the panel does not correspond to the actual temperature, it can be adjusted by $\pm 5^{\circ}\text{C}$ in the panel. Applies also to display of external temperature.</p>		<p>16. High altitude mode The function should only be used if the boiler will be powered by LPG at a height above 1000 m above sea level. NB. For LPG operation at high altitude, use propane to obtain stable combustion. NB. Variations in operating conditions at high altitudes can mean that the boiler always achieves stage 1 output, but not always stage 2 on LPG operation.</p>
	<p>17. Circulation pump settings Cont. This function limits the supply of hot water, particularly when there is a low heating requirement. Therm: The pump is controlled by the room sensor. This is the normal mode for heat and hot water.</p>		<p>18. Automatic boiler start Starting the boiler at a certain time/on a certain day. The boiler will be on every week during the time set, until the function deactivated. For automatic start to function, the boiler must be turned off.</p>
	<p>19. Sound Audible signals in various situations:</p> <ul style="list-style-type: none"> • Turn the button sound on and off. • Audible signal on reaching hot water temperature when Alde Flow* is installed and more hot water is selected. • Audible signal on "Gas Failure". • Audible signal on LPG bottle change if a duoControl* is installed and activated in "Installed Accessories". 		<p>20. Reset Pressing Reset resets the panel to its factory settings. NB. Settings made in installed functions are not deleted</p>
	<p>21. External start The function is used when starting the boiler from outside. When external start has been activated the panel must be turned off, but 12V should be connected. The parameters/functions that the boiler is to have when it starts must be set before turning off the control panel. NB. Using this function requires installation of an accessory that can use external start.</p>		

Functions marked with a (*) are accessories, which are not installed on all vehicles, refer to the vehicle manufacturer's instructions.



Compass

HOW TO USE YOUR CARAVAN'S EQUIPMENT



	<p>21. (continued from over)</p> <p>230V. The function is used to start the boiler by connecting 230V to the vehicle. When the 230V function has been activated the control panel must be turned off, but 12V should be connected. The parameters/functions that the boiler is to have when it starts must be set before turning off the control panel (230V connected). Certain vehicles can be equipped with an individual solution (*winter connection).</p>	<p>Lang</p>	<p>22. Language</p> <p>Switch between different languages. Available languages are English, French and German. However, the service menu is only available in English.</p>
<p>Installed Accessories</p>	<p>23. Installed functions</p> <p>The accessories that are installed are activated here.</p>	<p>Service</p>	<p>24. Service menu</p> <p>This contains the following, amongst others:</p> <ul style="list-style-type: none"> Glycol temperature Domestic hot water temperature 12V power to the boiler
<p>To exit the tools menu, press Return or Menu.</p>			

Service Menu

The service menu is accessed by pressing Service (see Fig. 1). The function shows the values from the boiler on the screen (Fig 2 to 4). The values are updated every second.

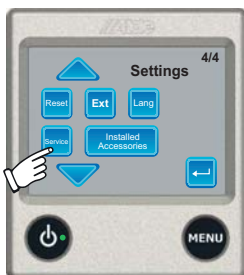

Figure 1



Figure 2

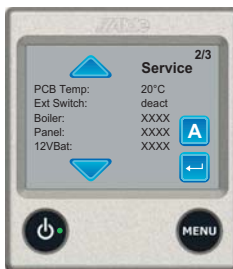

Figure 3

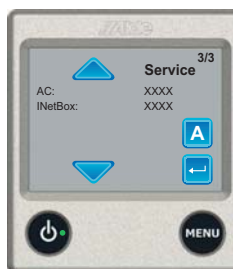
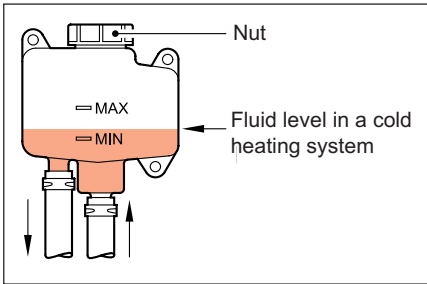

Figure 4

Fluid level of heating system



CAUTION: The heating system comes installed with glycol heating fluid. If the fluid level is too low you must fill the system to the right level before operating the heating system.

Your warranty may be voided and the heating system may be damaged if you attempt to start it with little or no glycol heating fluid.

Note: Do not mix different types of glycol; this can lead to coagulation of the glycol fluid.

Note: Omitting to change the fluid can result in frost damage, corrosion, bacterial growth and/or overheating.

Note: The Alde Premium Antifreeze should be changed at intervals of 5 years when under normal operating conditions.

For further information about your Alde system, please refer to Alde Handbook.



MICROWAVE (When installed)

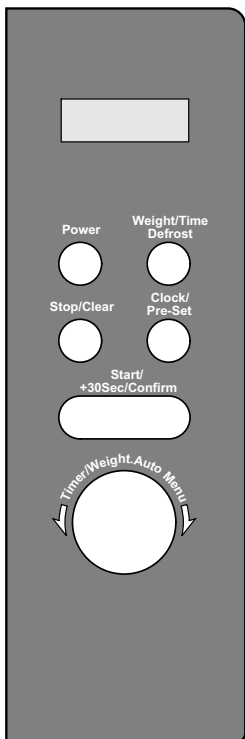

MENU ACTION SCREEN Cooking time, power, auto and the clock time are displayed.

POWER Press to select the power level for microwave cooking.

WEIGHT/TIME DEFROST Press this button to input weight for defrosting.

CLOCK/PRE-SET Press this button to input weight for defrosting.

STOP/CLEAR Press to stop the cooking process.

TIMER/WEIGHT . AUTO MENU Rotate to select the cooking time and the auto menus.

START/+30SEC/CONFIRM Press this button to start the cooking process and confirm when programming.

DOOR OPEN Pull the handle to open the door.

Microwave cooking

- 1 Press the "POWER" button once and "P100" will display and flash.
- 2 Turn the "TIMER/WEIGHT" to select the microwave power. "P100", "P90", "P80", "P70", "P60", "P50", "P40", "P30", "P20", "P10" and "P00" will display in order.
- 3 Press "START/+30 SEC" to confirm.
- 4 Turn the "TIMER/WEIGHT" dial to adjust the cooking time. (The time setting should be between 0:05-95:00).
- 5 Press "START/+30 SEC" to start the cooking process.

Press power button	Cooking power
P100	100%
P90	90%
P80	80%
P70	70%
P60	60%
P50	50%
P40	40%
P30	30%
P20	20%
P10	10%
P00	0%

To stop the cooking process at any time press the "STOP/CLEAR" button.

For further appliance information please refer to microwave user manual.

BATTERY CHARGER

The battery charger for the caravan battery will automatically switch on when the caravan is connected to a mains supply. The battery charger will also provide a 12V supply to the caravan when a battery is not connected. Please note that the battery charger fitted is designed to keep your battery charged and is not designed for charging up a flat battery.

SMOKE ALARM

Operation

Normal Condition

The red LED on the front should flash every 40 seconds to show that the alarm is active.

Lower Power Pack Condition

IMPORTANT: Your smoke alarm requires the power pack to have sufficient capacity of power to operate correctly.

Should your smoke alarm enter a low power pack condition, the unit will emit an audible 'chirp' once every 40 seconds. When this occurs, we recommend you replace the alarm immediately. Your smoke alarm will continue to warn of this low power pack for at least 7 days, however, failure to change the alarm after this time would mean your smoke alarm may have insufficient power to alert you in a real fire situation. When the alarm is removed from the base plate the power pack will automatically deactivate and the low power warning chirp should stop, allowing you to dispose of the alarm.

Low Battery Warning Silence

This feature can temporarily silence the low battery chirp for 8 hours which is particularly useful if the warning begins during the night. This feature may be repeated up to 10 times, but is not a substitute for replacing the smoke alarm.

Alarm Test

The alarm must be properly attached to the base plate before it can be tested.

- Press the test button in the centre and release.

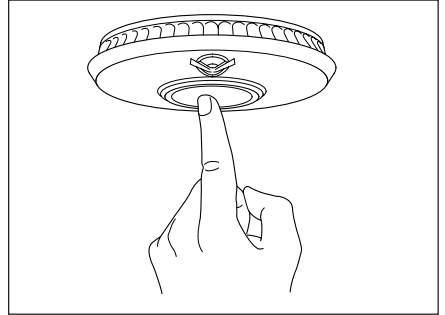

- The unit will give an audible alarm consisting of 2 cycles of 3 loud beeps, then stop automatically.

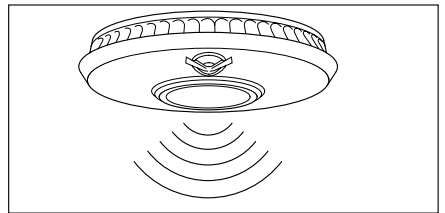

- The red LED on your alarm will flash rapidly during the audible signal.

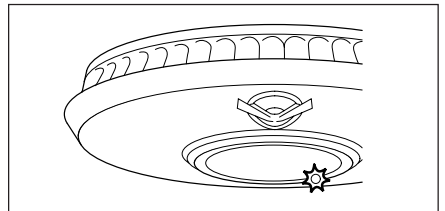

Note: The test button accurately tests the alarm's smoke sensing circuit, there is no need to test your alarm with smoke. If your smoke alarm fails to give an audible test signal, please refer immediately to the trouble shooting guide at the end of this manual.

WARNING: You should test your smoke alarm every week.



ALARM SMART SILENCE™

DANGER: If your smoke alarm emits the full alarm signal and you are not testing the unit, the smoke alarm is warning you of a potentially dangerous situation that requires your immediate attention. Only use the alarm silence function after making sure that there is no ongoing fire emergency situation. Do not block the vents on the alarm or disable the smoke alarm in any way, as this will remove your protection. Smoke alarms can sometimes react to cooking fumes or other non emergency situations. Your smoke alarm features "Smart Silence" technology. In the event of a known false alarm your smoke alarm can be temporarily silenced by pressing the central test button. Your alarm will automatically return to full sensitivity within 10 minutes.

Note: If the level of smoke reaching the alarm is very high, the alarm silence will be overridden and the alarm will continue to sound.

- Press and release the silence button, the alarm sound will shortly stop.

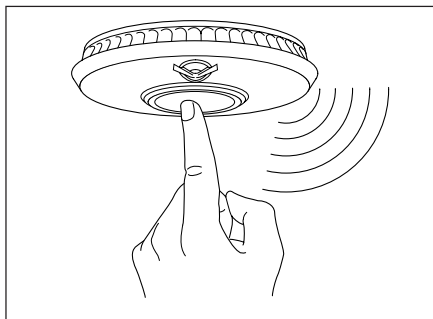

- Your alarm will silence and enter into a reduced sensitivity reset cycle for approximately 10 minutes.

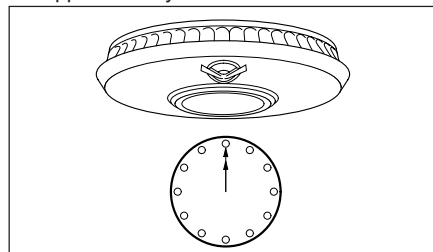

- During the reduced sensitivity reset cycle, the red LED on your alarm will continue to flash more rapidly than normal, approximately once every second.

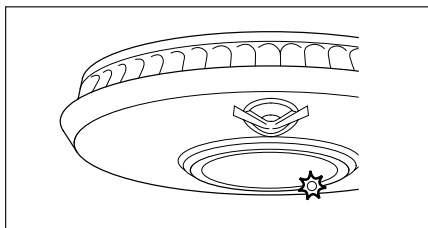

- Your alarm will automatically return to full sensitivity on completion of the reset cycle and the red LED will revert to flashing once every 40 seconds.

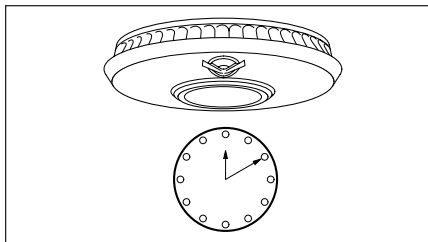

DANGER: Never ignore any alarm. Ignoring the alarm may result in injury or death. If your smoke alarm activates and alarms and you are not absolutely certain of the source of the smoke, get everyone out of the caravan immediately.

LOW BATTERY WARNING SILENCE

Low battery warnings often start at night or when it maybe inconvenient to replace your alarm. You can silence the audible chirp for a period of 8 hours by pressing the test button. Your smoke alarm will still detect smoke during this time of low battery warning silence. However, it is recommended that you replace your alarm immediately and certainly within 7 days, as your alarm may then have insufficient power to warn you of a real fire situation after this time.

WARNING: Your smoke alarm cannot be silenced if the chirp is indicating a fault. In this instance, the unit should be replaced immediately to ensure protection in the event of a fire.

MAINTENANCE

Your smoke alarm has been designed to be as maintenance-free as possible, however there are several things you must do to keep it working properly.

CAUTION: Your smoke alarm is a sealed electrical device and no attempt should be made to open the case. Attempting to open the case will invalidate your warranty.

Testing

Test your smoke alarm once every week see 'Alarm Test'. Any test failures should be reported to the Technical Support Team.

Cleaning

As a minimum your smoke alarm should be cleaned once every 3 months using your vacuum cleaner fitted with the soft brush attachment.

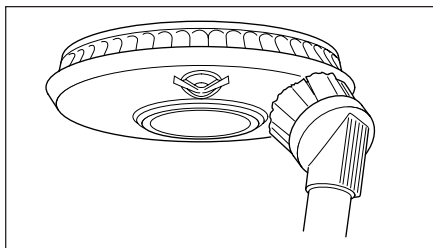

WARNING: Your smoke alarm may false alarm when it is being cleaned using a vacuum cleaner.

IMPORTANT: Do not use solvents or cleaners on your smoke alarm, as they may cause damage to the sensor or circuitry. The unit can be wiped with a slightly damp cloth.

CAUTION: Do not paint the smoke alarm as this may block the openings and prevent smoke from entering the sensor.

CARBON MONOXIDE ALARM

Carbon monoxide and how it can affect you and your family

Carbon monoxide is a dangerous poisonous gas that kills hundreds of people each year and injures many more. It is often referred to as the silent killer because it has no odour or taste and cannot be seen. Like oxygen, CO enters the body through the lungs during the normal breathing process. It competes with oxygen by replacing it in the red blood cells, thereby reducing the flow of oxygen to the heart, brain and other vital organs. In high concentrations, CO can kill in minutes.

Many cases of reported carbon monoxide poisoning indicate that while victims are aware they are not feeling well, they become disorientated and unable to save themselves by either exiting the building or calling for assistance. Exposure during sleep is particularly dangerous because the victim does not wake up.

Symptoms of CO poisoning

The following symptoms may be related to CO poisoning which all household members should be made aware of:

- Mild Exposure: Slight headache, nausea, vomiting, fatigue (often described as 'flu-like' symptoms).
- Medium Exposure: Severe throbbing headache, drowsiness, confusion, fast heart rate.
- Extreme Exposure: Unconsciousness, convulsions, cardiorespiratory failure, death.

Your CO detector monitors the level of CO as parts per million (ppm) in the atmosphere surrounding the detector.

- 35ppm The maximum allowable concentration for continuous exposure for healthy adults in any 8 hour period, as recommended by the Occupational Safety and Health Administration (OSHA).
- 200ppm Slight headache, fatigue, dizziness, nausea after 2-3 hours.
- 400ppm Frontal headaches within 1-2 hours, life threatening after 3 hours.



800ppm Dizziness, nausea and convulsions within 45 minutes.
Unconsciousness within 2 hours.
Death within 2-3 hours.

Should you suspect CO may be affecting you or your family, open the doors and windows of your caravan to ventilate, turn off your appliances and evacuate the premises. At this time the authorities should be contacted to locate the source of the carbon monoxide before re-entering the caravan. Medical attention should be sought for anyone suffering the effects of CO poisoning.

Common sources of CO

- Oil and gas boilers
- Portable generators
- Oil or solid fuel cookers
- Barbecues
- Clogged chimneys
- Wood or gas fireplaces
- Cigarette smoke
- Gas appliances
- Any fossil fuel-burning appliance

WARNING: This carbon monoxide detector is not a combustible gas detector, nor a smoke detector. Please install the proper detectors to detect combustible gases, or smoke.

This CO detector should not be seen as a substitute for the proper installation, use and maintenance of fuel-burning appliances (including appropriate ventilation and exhaust systems), nor the sweeping of chimneys.

WARNING: Variables relating to your fuel-burning appliances can change at any point eg. the flue or chimney could suddenly become blocked or damaged, appliances may stop running correctly or circumstances in neighbouring properties may change resulting in the presence of carbon monoxide. For this and other reasons do not use this carbon monoxide detector on an intermittent basis, or as a portable detector or an intermittent basis, or as a portable detector for trying to trace one source of the spillage of combustion products from fuel-burning appliances or from chimneys.

Do not:

- IGNORE ANY WARNING FROM YOUR CO DETECTOR!
- Burn charcoal inside your home, caravan, tent or cabin.
- Install, convert or service fuel-burning appliances without proper knowledge, skill and expertise.
- Use a gas cooker for heating a room.
- Operate unvented gas burning appliances using paraffin or natural gas in closed rooms.
- Operate petrol-powered engines indoors or in confined areas.
- Barbecue indoors, or in an attached garage.
- Ignore a safety device when it shuts an appliance off.

Always:

- Buy appliances accepted by a recognised testing laboratory.
- Install appliances according to the manufacturer's instructions.
- Have appliance installations carried out by professionals (for gas appliances engineers should be registered on the Gas Safe register).
- Have your appliances checked regularly by a qualified service engineer.
- Have your chimneys and flues cleaned professionally every year.
- Make regular visual inspections of all fuel-burning appliances.
- Open windows when a fireplace or oil/solid fuel cooker is in use.
- Only install CO detectors that meet the requirements of EN 50291-1: 2010 and EN 50291-2: 2010 in your home.
- Be aware of CO poisoning symptoms.
- Educate yourself and your family on the sources and symptoms of CO poisoning and how to use your carbon monoxide detector.

Operating Features

Your detector offers many features which set it apart from other CO detectors on the market today.

Test/Reset button feature

- Test the sounder, batteries and circuitry.
- Allows you to test the sensor by introducing a source of CO into the detector (see 'Testing the Sensor').
- Silence the loud 85dB sounder during an alarm (only possible when current CO level is less than 50ppm).

Testing the sounder, batteries and circuitry

Test the sounder, batteries and circuitry by pressing and holding the Test/Reset button for 1 second to confirm that the detector is operating properly. The sounder should sound as soon as the button is pressed and the Alarm LED will illuminate red, indicating that the sounder is working and the batteries are providing power to the unit. This test for the sounder, batteries and circuitry should be performed weekly.

Testing the sensor

CAUTION: Sensor testing should only be performed by a responsible adult. This test should only be performed once a year. Excessive testing will cause the life of the alarm to be shortened.

Note: Aerosol CO may be used in order to avoid having to burn incense sticks.

Read all steps thoroughly before attempting to test the sensor.

Step 1 If the detector is wall or ceiling mounted unhook the detector from the screws.

Step 2

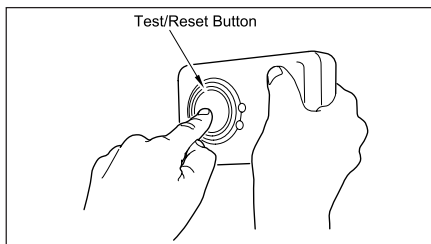

Cover the sounder vents with one hand. Press and hold the Test/Reset button down with your thumb/finger until the Power LED illuminates green and the sounder sounds for a second time (this should happen after around 5 seconds). Release the Test/Reset button. Upon releasing the Test/Reset button the Power LED will flash green once every second. This indicates that the sampling rate of the detector has increased and can be tested using a known source of CO.

Step 3 Light an incense stick using a match or lighter. Be sure to blow out the flame so that the incense stick is smouldering. Extinguish the lighter, or put out the match and place it into a dish of water.

Step 4

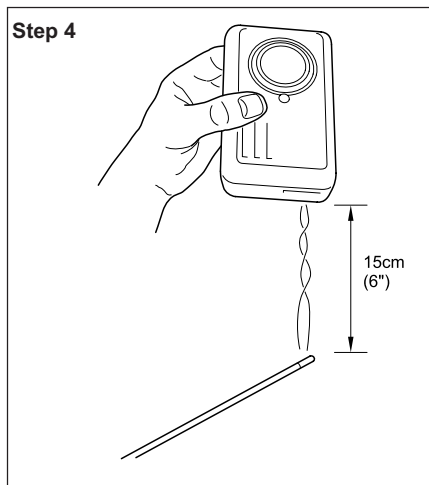

Turn the detector on its side so that the vents on the right hand side of the detector are pointing downwards. Hold the burning incense stick around 15cm (6 inches) below the detector, so that the smoke enters the vents on the side of the detector. An increase in the localised carbon monoxide level within the sensor to more than 50ppm will cause the sounder to sound for one cycle of



four loud beeps and the Power LED to illuminate green for a short time. This is the end of the test. The Power LED will no longer flash green every second but will revert to flashing once every minute as the detector will go back to normal operating mode (it may take up to two minutes of exposure to the smoke for the localised level of carbon monoxide within the sensor to reach over 50ppm). Now move the source of CO away from the detector as the test is finished.

Step 5 After step 4, put out the incense stick by placing it into a dish of water. Ensure that all flames have been extinguished.

Note: If the localised carbon monoxide level within the sensor does not reach 50ppm during the test, the sensor test will stop automatically after 3 minutes.

Understanding the products indicators

The higher the concentration of carbon monoxide detected by the detector, the quicker it will respond. When sufficient carbon monoxide is detected a loud audible signal (85 dB at 1m/3 feet) will be emitted and the Alarm LED will flash red once every second.

The alarm will sound:

- Between 60 and 90 minutes when exposed to 50ppm of CO.
- Between 10 and 40 minutes when exposed to 100ppm of CO.
- Within 3 minutes when exposed to 300ppm or more of CO.

Fault/End of Life signal:

The unit continuously checks the settings of its sensor and circuitry. If any of these settings are found to be incorrect or if the batteries become low then the detector will emit a single audible chirp once per minute for up to 30 days. **IMPORTANT:** This does NOT mean that the detector has detected carbon dioxide.

Replace batteries immediately. If the product continues to chirp despite having new

batteries and the product is still within warranty then contact Technical Support for advice. If the product is no longer in warranty replace it immediately.

Maintaining/testing your detector

Your detector will alert you to potentially hazardous CO concentrations in your home when maintained properly. To maintain your detector in proper working order and to ensure that the sensor will last for the lifetime of the product, it is recommended that you:

- Test the sounder, batteries and circuitry of your detector once per week by pressing and holding the Test/Reset button for 1 second.
- Perform the sensor test annually.
- Keep the detector free of dust by gently vacuuming the case with a soft brush attachment every 3 months.

To prevent the possibility of contaminating the sensor in your detector and thus affecting its reliability:

- Never use cleaning solutions on your detector. Simply wipe with a slightly damp cloth.
- Do not paint the detector.
- Do not spray aerosols on or near the detector.
- Do not use any solvent based products near the detector.
- If installing in a caravan or boat there may be other substances present that may not normally be found in the home that could affect the reliability of the CO alarm. Avoid using the following in close proximity to the alarm; oils, cleaning fluids, polishes, paints and greases.
- Do not attempt to repair your CO detector. Do not remove any screws or open the main casing of your detector. Any attempt to do so may cause malfunction and will invalidate the warranty.



THETFORD C-260 CASSETTE TOILET RANGE

Introduction

The Thetford Cassette Toilet is a high quality product. The toilet forms an integral part of your caravan bathroom, thanks to its functional design which combines modern styling and ease of use. The C-260 Cassette Toilet is manufactured from high quality synthetic materials which makes it a durable, user and maintenance friendly toilet.

The toilet is made up of two parts: a permanently fixed part and a Waste Holding Tank that is accessible from the outside. The removable Waste Holding Tank is located under the toilet bowl and can be removed via a door on the outside of the caravan. The Thetford Cassette Toilet is the solution to the sanitary problem in your caravan!

The operating instructions cover Thetford Cassette Toilet models C-260S, C-260CS (models connected to the vehicle's central water tank) and C-260CWE (model with its own flush-water tank). There are differences in the use of these models. Please ensure that you follow the instructions that apply to your toilet model.

Preparing for use (standard)

1. Open the access door on the outside of your caravan.
2. Remove the Waste Holding Tank by pulling the safety catch (which holds the tank in place) upwards.
3. Pull the Waste Holding Tank outward to the stop. Tip it slightly and take the tank fully out.
4. Place the tank upright and turn the rotating emptying spout upwards. The emptying spout ensures that the tank can be easily and hygienically emptied.
5. Remove the cap, with the measuring cup inside, from the emptying spout and pour the correct dosage of Thetford toilet fluid (see product label) into the holding tank. This avoids unpleasant smells and keeps the inside of the tank clean. Next add approximately 2 litres of water - enough to ensure that the bottom of the Waste

Holding Tank is covered. Far more information on Thetford toilet fluids, see last page of this manual. Screw the cap back onto the emptying spout and turn back to its original position.

Note: The Emptying Spout Measuring Cap is supplied in the same packaging as this manual.

WARNING: Never add toilet fluid directly via the blade or the toilet bowl as this could damage the lip seal of the Waste Holding Tank. Always pour the fluids via the emptying spout.

6. Slide the Waste Holding Tank back into its original position via the access door. Make sure that it is secured with the safety catch. Close the access door and lock it. Your Thetford toilet is now ready to use.

WARNING: Never use force if you cannot get the tank back into place easily. This may cause serious damage. If blockage occurs, always check if the blade handle is in the correct (closed) position.

7. For toilets with own Flush-Water Tank: Open the water filling door and fill the flush-water tank with the correct dosage of Aqua Rinse. This Thetford toilet fluid keeps the flush water fresh and improves the flushing. Next, fill up the flush-water tank with clean water (approximately 8 litres) using a ferry can or hose. Your toilet is now ready to use.

Preparing for use with Optional Features

8. Automatic Ventilator: Open the access door on the outside of your caravan and remove the Waste Holding Tank (as described above).
9. Remove the filter housing cover and if no filter is present, place a new filter into the filter housing. Peel off the sticker lids on the filter. Place back the cover of the filter housing.

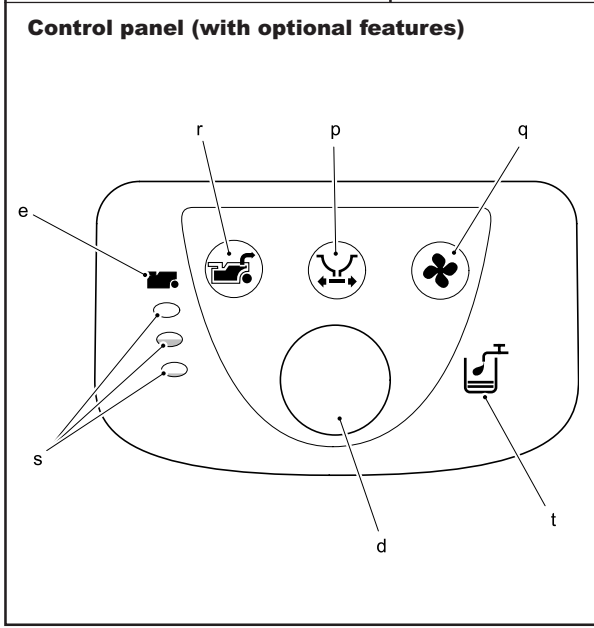
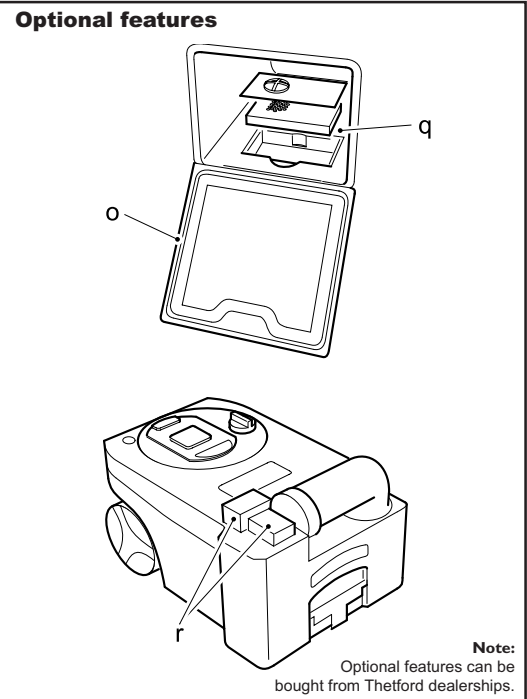
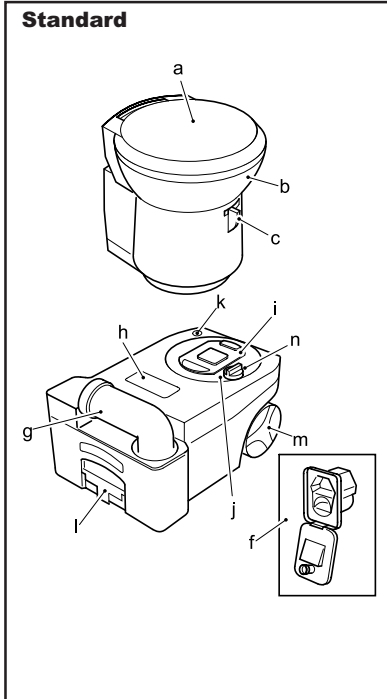

- PARTS**
- a) Removable Seat and Lid
 - b) Swivelling Toilet Bowl
 - c) Blade Handle
 - d) Flush Button
 - e) Waste Holding Tank Level Indicator
 - f) Water Filling Door (only if toilet has own flush-water tank)
 - g) Rotating Emptying Spout
 - h) Automatic Pressure Release Vent
 - i) Sliding Cover
 - j) Removable Mechanism
 - k) Vent Plunger
 - l) Pull-out Handle
 - m) Wheels
 - n) Blade Openener
 - o) Access Door to Waste Holding Tank
- Optional Features**
- p) Electric Blade
 - q) Automatic Ventilator
 - r) Waste Pump-Out System
 - s) Waste Holding Tank Multi-Level Indicator
 - t) Flush-Water Tank Level Indicator (only if toilet has its own flush-water tank)



Using the toilet (standard)

10. Turn the bowl to the desired position with the lid closed and using both hands.
11. To activate the control panel, press the flush-button once. The control panel display will stay activated for approximately 5 minutes. Run some water into the bowl by pressing the flush button again briefly.
12. The toilet may be used with the blade open or closed. To open the blade, slide the blade handle under the toilet bowl sideways. After use, open the blade (if still closed) and flush the toilet by pressing the flush button for several seconds (if necessary re-activate the control panel). Close the blade after use.

WARNING: If your toilet has its own flush-water tank, please make sure that you do not travel with a flush-water tank that is too full. Do not travel with water in the toilet bowl. Failure to adhere to this notice may result in water damage to your caravan or motor home.

Using the toilet with Optional Features

13. Electric Blade: Push the electric blade button on the control display to electrically open or close the blade. In the case of failure, you can manually open or close the blade by sliding the small handle under the toilet bowl sideways.
14. Automatic Ventilator: The ventilator automatically starts when the control panel is activated (by pressing the flush button) and will automatically shut off after approximately 5 minutes. The Automatic Ventilator Indicator will flash until automatic shut-off occurs. If you want to stop the ventilator, press the Automatic Ventilator button. If you want to re-start the ventilator, press the button again (the LED will start flashing again).
15. Flush Water Tank Level Indicator (only for toilets with own flush-water tank): When the Flush Water Tank Level Indicator lights up, refill the flush-water tank, as only about 1.5 litres of water is left in the tank, which is sufficient for approximately 2 flushes.

Emptying

The Waste Holding Tank has a capacity of 18 litres and requires emptying when the red light (LED) on the toilet control display lights up, when the Waste Holding Tank only has capacity for approximately 2 more litres, which is no more than two to three further uses.

Make sure that the blade is closed. Open the access door located outside the vehicle, pull the safety catch upwards and remove the Waste Holding Tank.

16. Place the Waste Holding Tank in an upright position (Pull-Out Handle at the top, Wheels at the bottom). Slide the handle sideways - to the front of the tank - until it snaps out of its locked position.
17. Pull the handle up and wheel the Waste Holding Tank to an authorised waste disposal point.
18. Push the handle back into its locked position. Turn the emptying spout upwards and remove the cap from the spout. Hold the Waste Holding Tank in such a way that during emptying you can operate the vent plunger with your thumb. To empty the tank without splashing, depress the vent plunger while emptying the tank. After emptying, rinse the tank and blade thoroughly with water.

WARNING: Do not seriously shake the tank or use high pressure water cleaners. This may cause damage to the tank's interior.

Note: The vent plunger should only be depressed once the emptying spout is pointing downwards. Prepare the toilet for re-use if required. Slide the Waste Holding Tank into the toilet and close the access door.

Emptying with Optional Features

19. Waste Holding Tank Multi-Level Indicator: The lower lamp indicates that the Waste Holding Tank is almost empty; the middle lamp indicates that it is more than half full; when the upper lamp lights up, the tank needs emptying as it can only take 2 - 3 further uses.



Note: The Waste Holding Tank Level Indicator will flash when the holding tank is not present. In this case the toilet will not flush.

20. Waste Pump-Out System: When activating the control panel this feature automatically lights up. When the Waste Holding Tank Level Indicator illuminates, press the Waste Pump-Out button to pump out the waste from the holding tank into the vehicle's waste tank. The button will flash while the waste is being pumped and will stop automatically (after approximately 5 minutes) when all waste has been transferred. If the vehicle's waste tank is full, the Waste Pump-Out light will flash rapidly and no pump-out will be possible until the central tank is emptied. (Check the level of the vehicle's waste tank on the vehicle's central console). After the Waste Holding Tank has been emptied, there will be approximately 1.5 litres of waste left in the tank. This is normal. Add 2 litres of water and a correct dosage of Thetford toilet fluids to the Waste Holding Tank.

CAUTION: It is vital that the correct amount of toilet fluid is added to ensure the proper breakdown of the waste in the holding tank. Only use the system when the tank is full. Using the system too often on an empty tank can cause damage to the pump, which could cause the system to fail.

Cleaning and Maintenance

The toilet should be cleaned and maintained regularly, depending on the amount of use. To clean Thetford toilets, we advise using water and Thetford Bathroom Cleaner.

Note: Never use bleach, vinegar or other powerful household cleaners that contain these substances. These may cause permanent damage to the seals and other toilet components.

Toilet Bowl

- Squirt Thetford Bathroom Cleaner into the toilet bowl.
- Flush the toilet bowl with water and wipe down the rest of the toilet with a damp cloth.

- Clean seat and lid The seat and lid can easily be removed: Lift the seat and lid assembly and pull the round pins (inside the assembly) outwards from the pin holes. After cleaning, replace the seat and lid by positioning the round pins in front of the pin holes and push the lid and seat downwards.
- To keep your flush water fresh and to prevent deposits from forming in your toilet bowl, add a correct dosage of Aqua Rinse in your flush water tank, if present, on your toilet.

Tip! For a really shining toilet, dry with a soft dry cloth after cleaning.

Waste Holding Tank

To keep your Waste Holding Tank fresh and clean, Thetford has developed a number of different toilet fluids. Thetford toilet fluids suppress smells, reduce formation of gas, promote breakdown of toilet waste and increase the life span of a mobile toilet. We advise a thorough cleaning of the Waste Holding Tank once each season. Next to using Thetford's Cassette Tank Cleaner, the powerful cleaning agent for the periodical cleaning of the Waste Holding Tank of your toilet, we suggest the following: -

- Remove the removable mechanism from the Waste Holding Tank by turning it anti-clockwise and rinse it under a tap.
- Remove the cover plate from the Automatic Pressure Release Vent by prising it up using a small screwdriver. Use one hand to push the Automatic Pressure Release Vent open while holding the float of the Automatic Pressure Release Vent on the inside of the tank with the other hand. Push the float upwards, turn it 180 degrees and remove it from below. Remove the rubber seal underneath the float. Rinse the float and rubber seal under a tap. Replace the rubber seal and float for the Automatic Pressure Release Vent using the same method in reverse.

The rubber seals in the toilet (the lip seal, the mechanism seal, the automatic pressure release vent seal and the cap seal) should be



regularly cleaned with water and treated with Thetford High Grade Seal Lubricant. This will ensure that the seals remain flexible and in good condition. If the toilet is not to be used for any length of time, it is important to treat the seals with Thetford High Grade Seal Lubricant after cleaning.

Note: Never use Vaseline or any vegetable oil except olive oil. These may cause leakage or malfunction. The lip seal is a part of the toilet that is subject to wear. Depending upon the extent and manner of use, the seals will become less effective and will need replacing periodically.

Cleaning and Maintenance for Optional Features

- Automatic Ventilation: The filter of the Automatic Ventilation needs to be renewed periodically. After approximately 4 full weeks of use, the filter loses its absorption power.
- Pump-Out Waste System: To ensure optimal functionality of the Pump-Out Waste System, periodical maintenance of the tube and pump is recommended. After emptying the Waste Holding Tank completely, fill it with clean water and empty it again. This will clean the pump and the hose. Do this once every 3 weeks when on holiday. This should ensure proper operation of the system.

Winter operation

You can use your Thetford Cassette Toilet as normal in cold weather as long as the toilet is situated in a heated location. If there is a risk of freezing we advise that the toilet is drained by following the instructions under 'Storage'. For environmental reasons the use of antifreeze, such as that used in car radiators, is not recommended.

Storage

It is important that you follow the instructions below if you do not expect to use your Thetford toilet for a long (winter) period.

- Activate the Control Panel by pressing the flush button. Open the blade and press the flush button until water stops flowing into the bowl. Close the blade.

Open the access door on the outside of your caravan or camper and empty the Waste Holding Tank at an authorised waste dump. Follow the instructions for cleaning and maintenance. To allow the Waste Holding Tank to dry, do not place the cap back on the emptying spout of the tank.

21. If the toilet has its own flush-water tank, place a sufficiently large bowl under the drain tube to catch the remaining water from the flush-water tank and remove the drain plug. When no more water exits, put the drain plug on the drain tube, put it back in its original position and close the access door. If the toilet is connected to the vehicle's water tank, please follow your vehicle's instructions for draining the central water system. If your toilet is optionally featured with a Waste Pump-Out System, take out the Waste Holding Tank and completely clean it (see Cleaning and Maintenance). After cleaning, fill it with water, put it back and empty it via the waste pump-out system. Repeat this twice.

Toilet unit malfunctions

Contact your dealer or a Thetford Service Centre.

We advise draining the fresh water tank prior to travelling. Antifreeze should not be required if the motor home is heated. If you do wish to use antifreeze, brands containing the following properties may be used in the fresh water tank:

- Ethylene glycol
- Mono-Ethylene glycol
- Propane-diol
- Glycerol
- Ethane-diol
- Glycol

Never use alcohol based antifreeze, i.e. Methanol, Ethanol, and Iso-propanol.



HOW TO USE YOUR CARAVAN'S EQUIPMENT

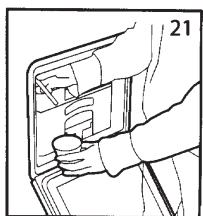
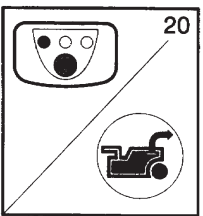
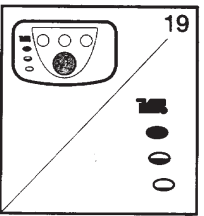
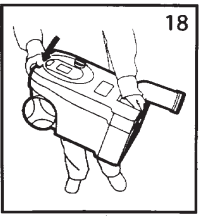
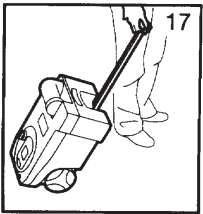
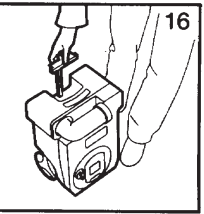
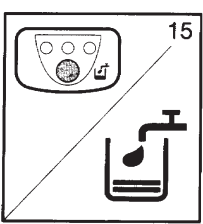
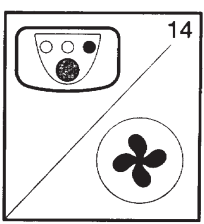
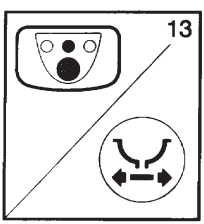
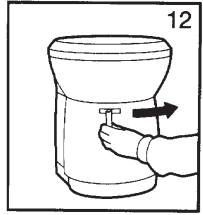
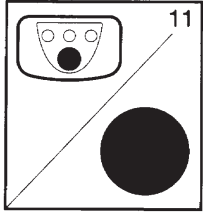
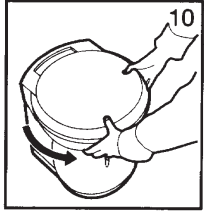
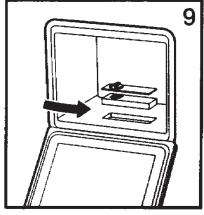
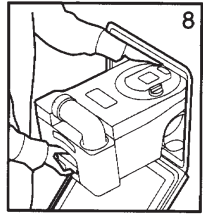
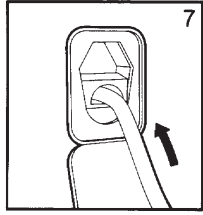
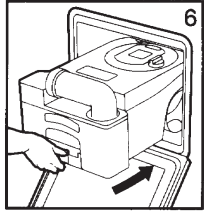
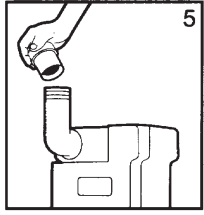
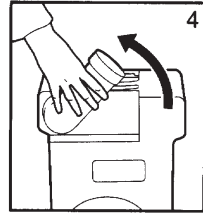
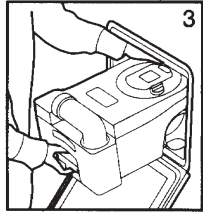
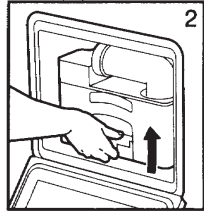
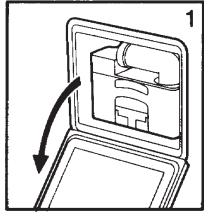



ROOFLIGHTS

Your caravan is fitted with at least one type of the following roof lights.

The Omivent (12v) Rooflight

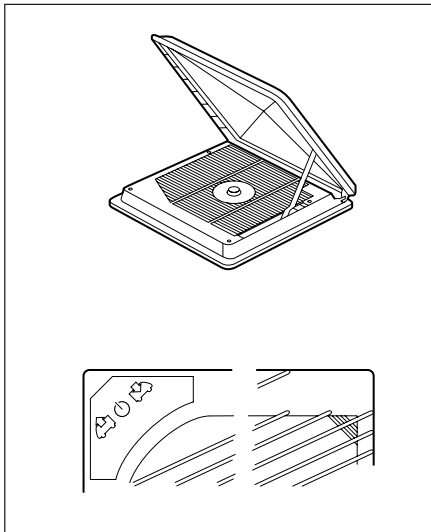

The Omivent is a double-glazed roof light constructed from a synthetic ultra-violet screened material. Its side-operating mechanism allows a completely free central opening with built-in fixed ventilation when closed. It operates as an extractor fan and air intake fan.

Please note: Do not change the direction of the fan unless it has been switched off 'O' position and the blades have stopped rotating.

The Heki 2 Rooflight

To open to the tilted position:

- (i) Press the knob in the toggle catches on either side of the rooflight and turn through approx. 90°.
- (ii) Grasp the metal bar in the middle, snap it out of its holder, swivel down and press the rooflight upwards. (The rooflight is held by the two gas springs after approx. 150mm).
- (iii) Swivel the metal bar towards the rooflight and snap into its holder.

- (iv) To close the rooflight, proceed with steps (i-iii) in reverse order.

To open in the intermediate position:

- (i) Open the toggle catches on either side of the rooflight.
- (ii) Grasp the metal bar in the middle; snap it out of its holder, swivel down and press the rooflight outwards. (Rooflight is opened automatically after approx. 150mm by the two gas springs.)
- (iii) Open both fasteners and swivel the metal strap toward the intermediate position and pull the rooflight down until the metal strap is stopped by the fasteners.
- (iv) To close, proceed with steps (i-iii) in reverse order.

To open in the ventilation position:

- (i) Open the toggle catches on either side of the rooflight.
- (ii) Using both hands on the two toggle catches, press the rooflight up about 2cm and fasten the toggle catches in the corresponding setting.
- (iii) To close, proceed with steps (i-ii) in reverse order.

Closing the blinds:

- (i) Take hold of the end rod (without rocker) in the recessed grip and engage in the opposite end rod (with rocker).
- (ii) Select the required position (blackout/ flyscreen) by moving both joined end rods together.

CAUTION: In extremely bright sunshine, the blackout blind must only be closed two-thirds, and the rooflight must be set in the continuous airing position.

Opening the Blinds:

- (i) Move blind (end rod with rocker) right to the outside.
- (ii) Hold the recessed grip with one hand; with the other hand, press the rocker and move the blind back (do not let it recoil).

CAUTION

- Do not stand on the acrylic rooflight.



- Close HEKI 2 completely before moving off.
- Do not leave your caravan when HEKI 2 is open.
- Please consult your supplying dealer if you have any problems or defects.
- Remove any snow/ice or dirt before opening the roof.
- Do not open when it rains or when there is a strong wind.

Midi Heki Rooflight

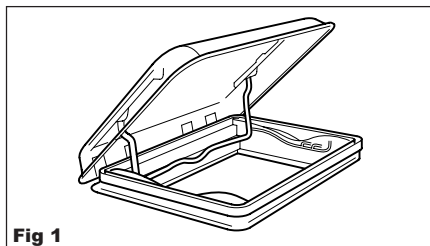

Fig 1

- (i) To open, push the large central button (Fig 2).

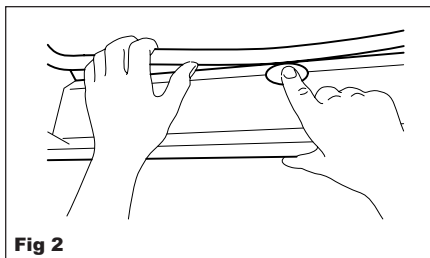

Fig 2

- (ii) Whilst depressed, slide the bar to the desired position and locate into the stops provided (Fig 3).

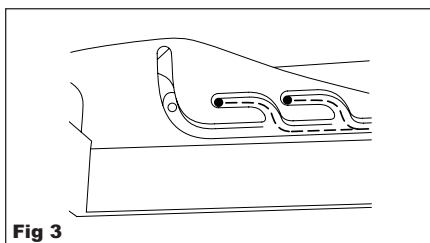

Fig 3

MPK Rooflight

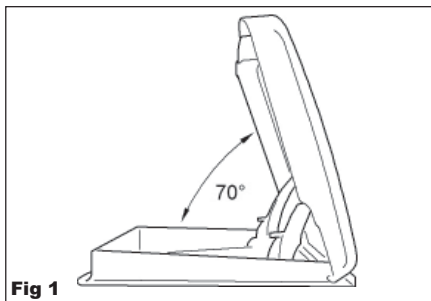

Fig 1

Instructions

The rooflight can be raised to an opening angle, on one side, to a maximum of 70° (Fig 1). To open, pull the operating bar down unlocking the mechanism. Now move the bar forwards (in direction of travel) and the rooflight will open; all the time holding the bar down. As soon as the operating bar is released it will lock into position and the dome will stay at this angle (Fig 2).

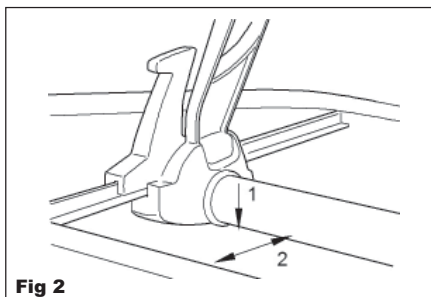

Fig 2

To close the rooflight, pull the operating bar down, unlocking the mechanism. Now, move the bar backwards (against the direction of travel) and the rooflight will close; all the time holding the bar down. Once you reach the end position the hooks will lock the rooflight automatically. Release the operating bar and the rooflight will remain closed (Fig 3).

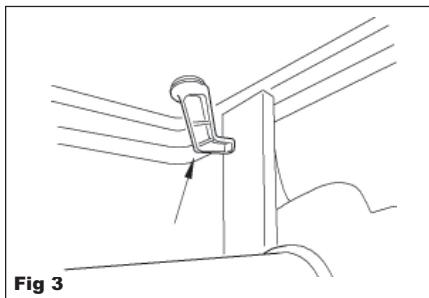

Fig 3

The flynet and the pleated blind can be operated together or separately. To open the rooflight dome both have to be opened.

WARNING: To avoid heat accumulation do not close blind completely during the day. Open both pleats when not using the vehicle.

Before driving

IMPORTANT: All rooflights must be locked down before travelling. Make sure the flynet and the blind are in open position to avoid damage and noise by airflow.

Stargazer Rooflight (if fitted)

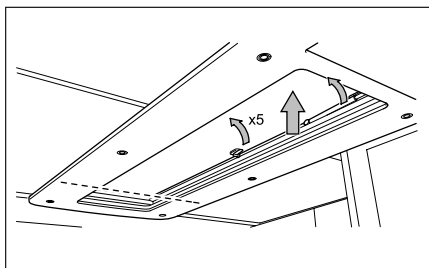

- (I) To open, first release all the plastic catches holding the rooflight in the closed position.
- (II) Then push the rooflight up as indicated in the illustration, note the rooflight is hinged at the location of the dashed line.
- (III) The rooflight will remain open on differing angles as it operates on a ratchet system.
- (IV) In order to close the rooflight push the rooflight up to its highest point and release it back down to the closed position.
- (V) Ensure the rooflight is closed and secured by the plastic catches before travelling.



WINDOWS

Your caravan will be fitted with Polyplastic framed windows.

Polyplastic Window Opening

- (i) In order to open the Polyplastic window it is only necessary to move the catch upwards and release the catch from the backing plate.
- (ii) The Polyplastic window should remain in the open position once opened, however if it does not then tighten the friction control on the window stays to increase the holding force.
- (iii) The Polyplastic window is also fitted with a night ventilation position where the catch is set to the centre position on the backing plate; in this position it may be possible for rain to enter the caravan in adverse conditions.

BLINDS & FLYSCREENS

Blinds

- (i) Pull blind down by its centre catch. Do not pull down by one side of the blind. This will inevitably lead to problems.
- (ii) Do not allow blinds to spring back freely. Always control them by hand.

Flyscreens

- (i) To operate the flyscreen, either pull the screen fully down, fully up or across, dependant on type of window fitted, and clip into place on the blind/frame.
- (ii) To release, unclip from the blind/frame. If a cross bar is fitted, gently pull the crossbar downwards towards you and allow the tension of the spring to roll up the flyscreen.
- (iii) Where a crossbar is not fitted, disconnect from the blind catch and release gently.
- (iv) It is recommended that blinds are not in the closed position whilst the caravan is moving.

Door Flyscreen

The exterior door flyscreen can be opened or closed from inside or outside the caravan and does not restrict door openings. When opening or closing the door flyscreen use the finger grip provided.



SHOWER

Using your Caravan Shower

To safely enjoy showering in your new caravan, the following guidelines should be used.

- Advise others that you are planning to have a shower and that they should not use other taps whilst you are showering.
- Ensure there is a sufficient supply of cold water available.
- Divert the shower head or move to the side, turn on the shower, carefully test the temperature with your hand and regulate the temperature as necessary before standing underneath the shower.
- Supervise closely the young, elderly and those with reduced mentally or sensory impairment.

CAUTION: Water may be very hot.

TAPS

Your new caravan will be fitted with a domestic style mixer taps.

WARNING: The water temperature could be very high so do not lift the lever with the tap turned to the full left position.

CAUTION: For winter storage and to prevent frost damage the tap swivel must be left in the centre up position.



GAS LOCKER DOOR

All caravan models are fitted with a gas strut supported door which will remain in the open position without the need for a holding bracket. This door will remain open unless locked by the key.

INTERNAL DOORS

Toilet/Shower Room Doors

Operation from within the shower room

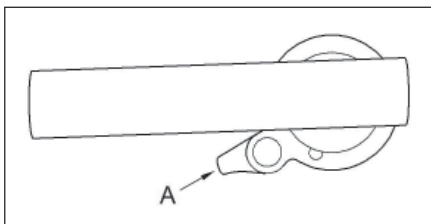

To lock the door, push the small lever down (identified in the drawing as A) then to unlock, push this lever back to the original position.

Operation from outside the shower room

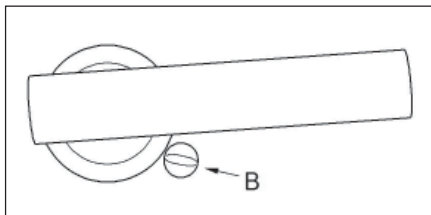

To open and close the door, push the lever down.

If the door is locked and needs to be opened, it can be opened by inserting a coin into the lower slot (identified in the drawing B) and turning the slot.

OTHER INTERNAL DOORS

Other internal doors such as the wardrobe and table storage locker are fitted with a 2-position button lock. Push the button to lock the door and the button should remain flush with the door. Push the button again to release and the button should then protrude from the door surface.

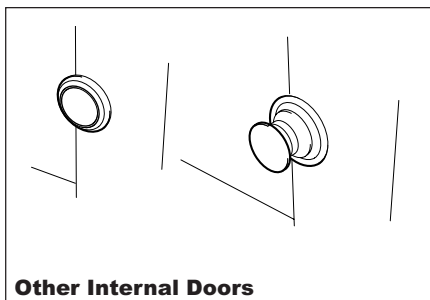

Other Internal Doors

HIGH LEVEL LOCKER

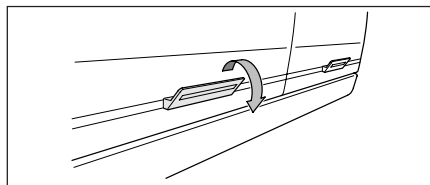

To open the locker, push the handle downwards.

CONCEALED LATCH

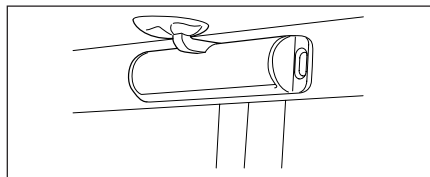

To open the locker, press the latch and pull the door towards you.

MAGNETIC CATCHES

Magnetic catches work on contact with the metal plate on the rear of the door. Simply close the door until the magnet engages and holds the metal plate. Pulling the door towards you with a moderate force will be sufficient to disengage the magnetic catch and open the door.

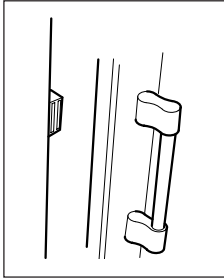

ROOM DIVIDER

The room divider should be held in place during transit by the use of the strap with the stud fastening. When stationary, the room divider can be held shut by fitting the retainer catch into the fitted keep.

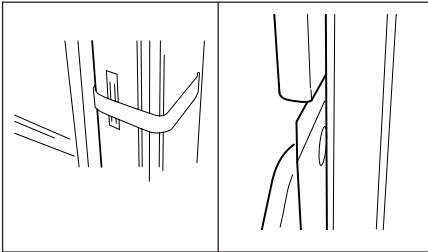



BED MAKE-UP

Parallel Lounge

The two single beds can be easily converted into a double bed by pulling out the bed slats, stored beneath the chest of drawers or stored in the bed slat box at the front/end of the caravan. Arrange seat cushions appropriately.

Day and Night Bed Makeup

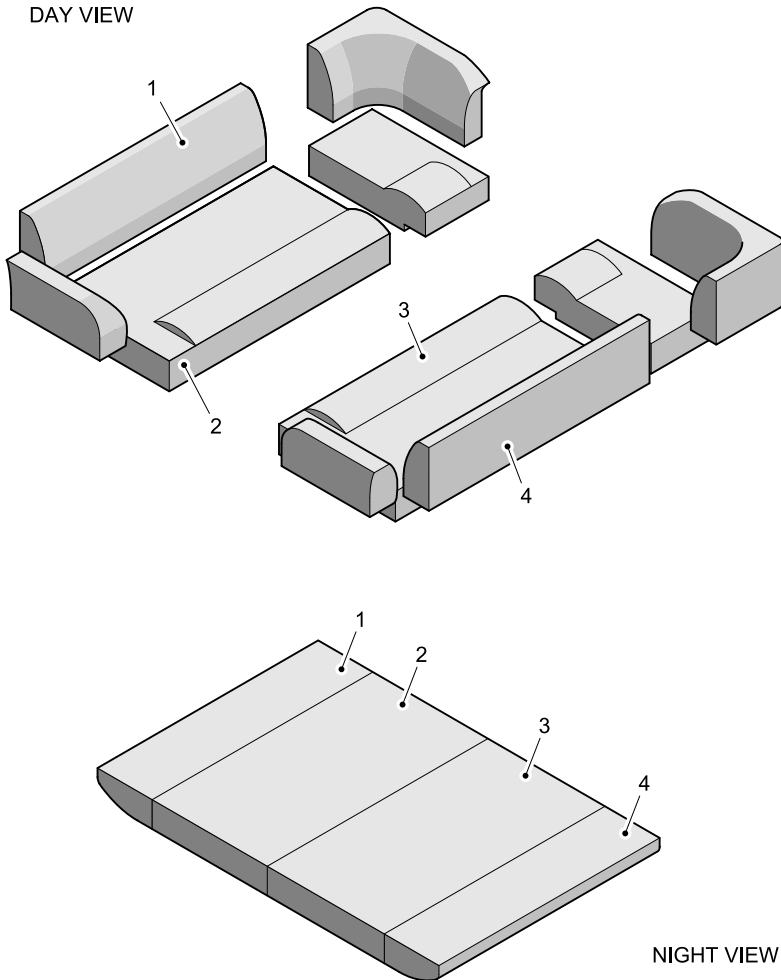



Camino 650

DAY VIEW

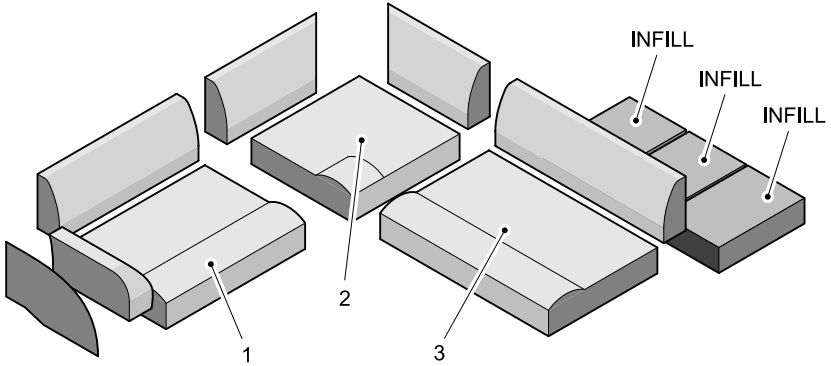

NIGHT VIEW

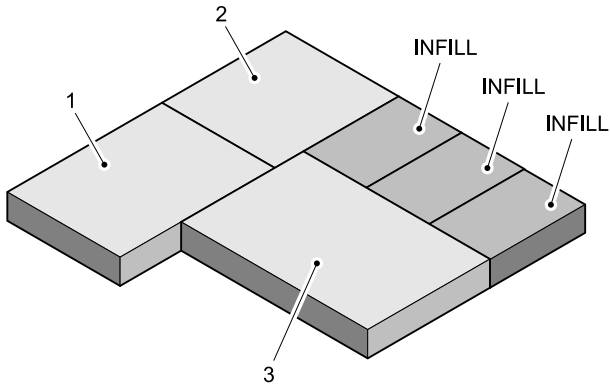



FRONT WRAP ROUND SEATING

(Option)

If you have purchased the wrap round seating option for your new caravan please note that the centre seat can be extended by the use of the locking mechanism which can be found under this seat.

Pull the slats forward then turn the locking plate to be in the direction down the caravan (see fig 1) in order to secure the front seat in place.

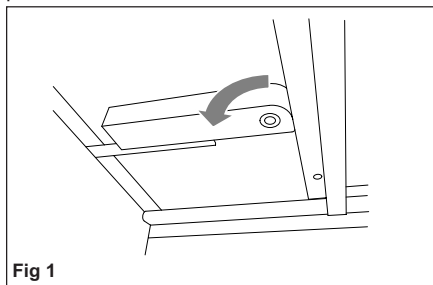

Fig 1

This will prevent the slats from going back into the front seat and increase the seated area.

Please ensure you return the locking plate to its normal position (see fig 2) if you wish to remove the wrap round seating.

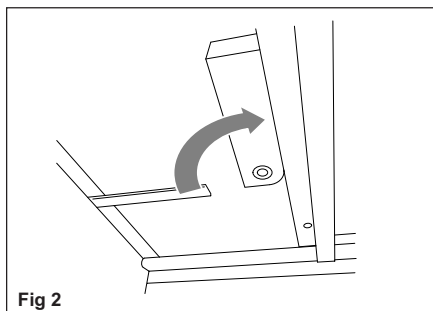

Fig 2

LIFT UP BED EXTENSIONS (where fitted)

The centre dinette bed has lift up extensions and these are operated by depressing the lever behind the flap of the hinge. While pressing the lever the extension flap can then be lifted into place.

This lever must also be depressed in order to lower the flap.

REMOVABLE DRAWERS

To remove from the caravan, first locate and release the retaining strap on the side of the unit.

Once the strap has been released the unit can be slid left as Figure A. The next step is to slide the unit forward as Figure B, once in this position the unit should simply lift out from the locator holes.

In order to return the unit to its original position, firstly locate the unit into the locating holes of the base unit. Once located then reverse the previous process.

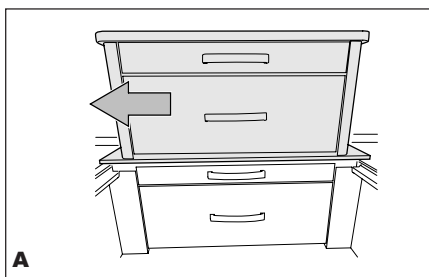

A

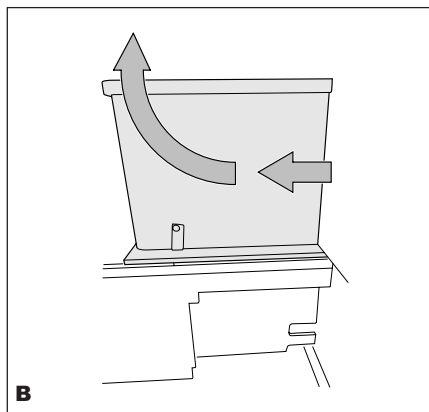

B

Radio with MP3 Connectivity

Details on how to set up and use the Radio will be contained in your document wallet.

TELECO TV AERIAL

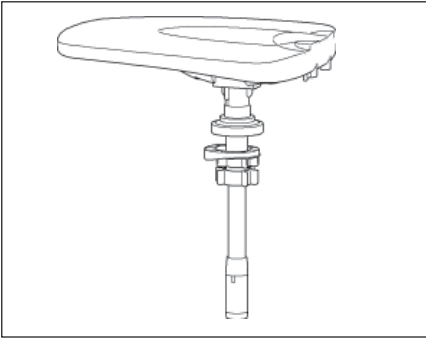

Instructions for the reception of horizontal or vertical polarity signals

In some areas certain TV signals are transmitted with horizontal polarity while others are transmitted with vertical polarity.

This antenna can be positioned both horizontally and vertically by simply turning the knob at the bottom of the mast.

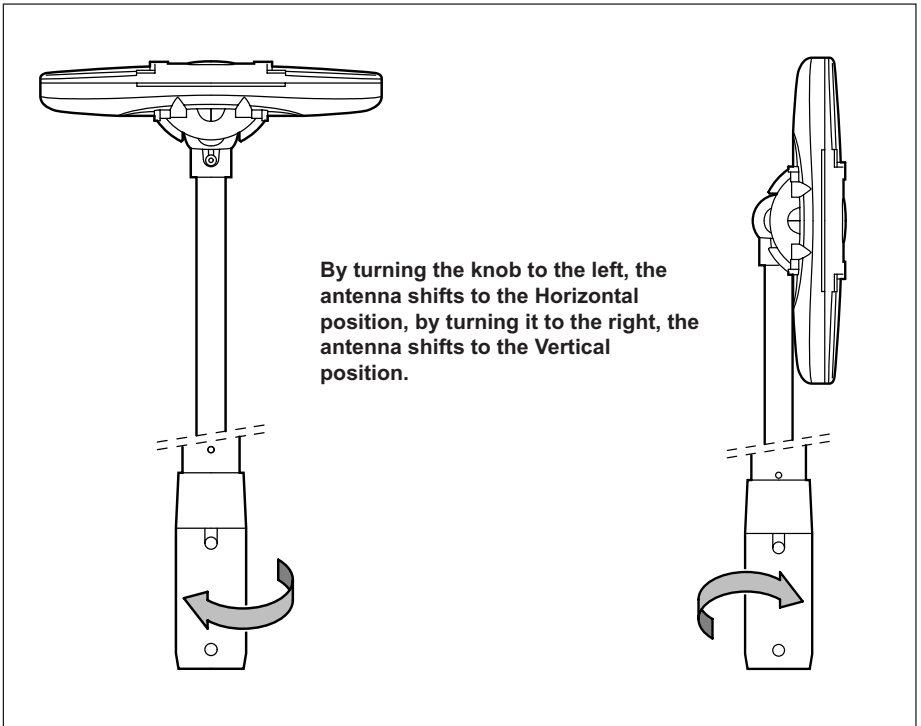



Connection to the amplifier

Connect the lead exiting from the pole to the ANT input of the amplifier. Connect with the relevant lead, the TV connector of the amplifier with the television. Connect the amplifier to 12 Vdc source, making sure you do not invert the + and - terminals.

Operating Instructions

- 1) Rotate slowly the dB dial of the amplifier clockwise to the maximum +
- 2) Tune the television to a channel available in the area where you are located.
- 3) Rotate and lift the antenna via the suitable pole until you get the best image on the TV.

Useful Tips

Not all the television signals you can receive in the zone where you are located will necessarily originate from the same direction. So if the quality of a programme image is poor try rotating the antenna as the signal may be coming from a direction different from the others.

Gain Adjustment

With the dB dial turned all the way clockwise, amplifier sensitivity will be at maximum and it is therefore able to receive the weakest signals. If, instead, the signals are too strong the images on the TV screen can have some stop or macroblocks. In this case rotate the dB dial anti-clockwise slowly until the image is perfect.

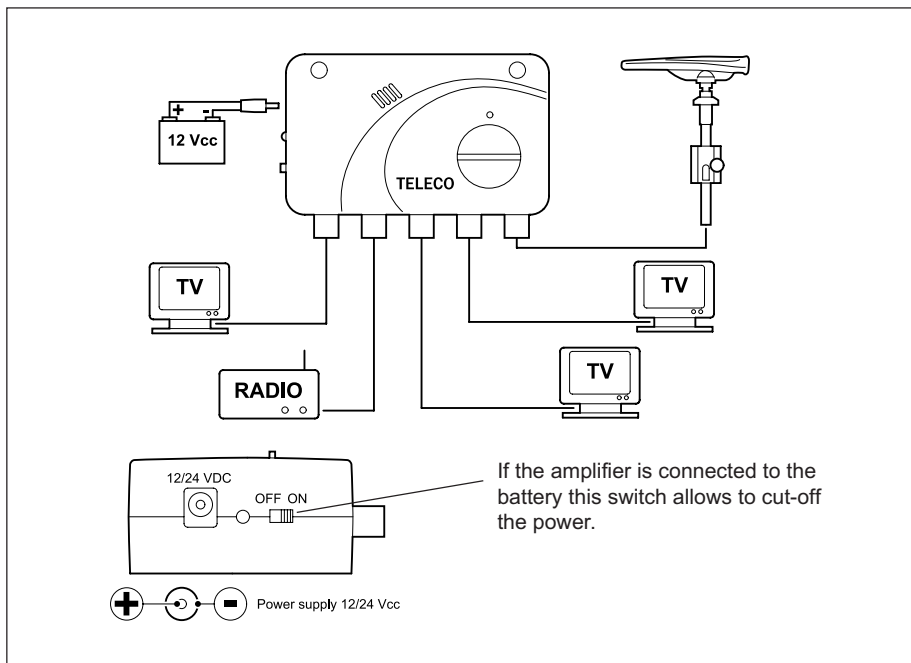

HOW TO USE YOUR TV AERIAL

Digital TV set-up guide

Connect aerial and power

Fix the TV to a bracket or place on a stable, flat surface, then connect the aerial cable and power lead to the TV and sockets.

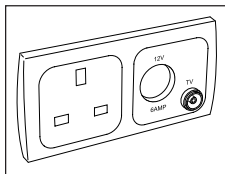

Check the power is on

The aerial needs power to work correctly; check that the power is switched on (Switch on either the mains and/or battery power to the vehicle) both power sources switch on the aerial (12 Volts).

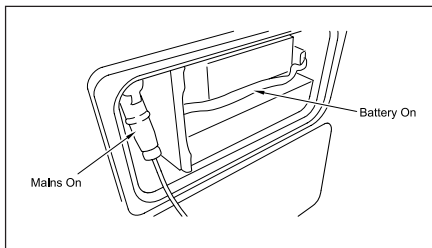

Tune in TV and choose transmitter

Switch on the TV and tune in the channels. If the vehicle is moved or a different socket is used you might need to re-tune TV. If the first transmitter picked up has poor quality pictures, then re-tune and pick another transmitter.

With Digital TV's there will be a re-tune button on the remote control use this feature and then choose manual re-tune.

Most digital TV's will also allow you to choose the transmitter which is normally available via the Menu function.

This will vary by TV manufacturer so if you have any problems undertaking this task please refer to your TV manual.

TROUBLESHOOTING GUIDE

Check aerial/radio fuse

If there is no power, check the 5 amp fuse located within the PDU marked radio is in working order.

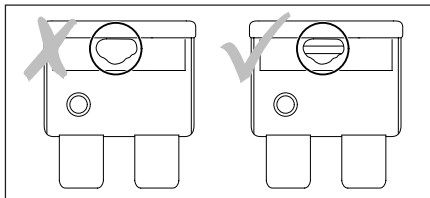

Check TV monitor

Check the TV is working correctly by ensuring that the channels tune in correctly in your home. If the TV does not pick up the expected number of channels we would recommend you get the TV checked out.

See step 6 shows how to tune your TV

Number of channels picked up from your house connections

DTV : 0	Programme(s)	X
Radio: 0	Programme(s)	
Data : 0	Programme(s)	

DTV : 72	Programme(s)	✓
Radio: 24	Programme(s)	
Data : 21	Programme(s)	

Check the coax lead is of good quality

Check that the TV aerial lead is of good quality (Normally cheap leads from the supermarket give reception problems, they are normally mass produced and made to a wider tolerance).

Ensure the coax lead from the aerial socket to the TV is suitable for digital reception (if in doubt, ask for advice).

Check location for signal strength

Check that the digital tv signal strength where the vehicle is situated is Very Good to Good.

Go to: www.digitaluk.co.uk

Enter the postcode and check signal strength.



Note: Sometimes transmitters are being repaired or upgraded

Go to: http://www.digitaluk.co.uk/help_and_advice/engineering_works

Check if signal is OK that day / week.

Check there are no obstructions

Is the vehicle outside in an open space?

Check that the vehicle has no obstructions:

House lean to/canopy

Trees (also blowing in the wind)

House or other buildings

Hills

Large vehicles

In a valley etc.



Understand digital signals

Digital signals have what the industry calls the Cliff effect.

The Cliff effect is either you have a picture or not within a very small difference of signal strength. This happens with both weak and strong signals.

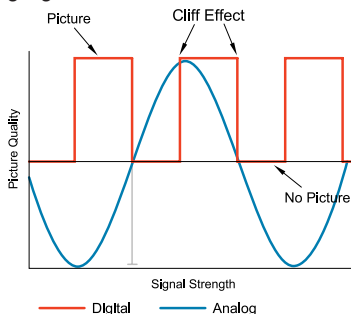

Troubleshooting guide - Checklist

Action	✓ or X
Check aerial fuse	
Connect aerial and power	
Check the power is on	
Tune in TV and choose transmitter	
Check TV monitor	
Check the coax lead is of good quality	
Check location for signal strength	
Check for obstructions	
Understand digital signals	

If after following this guide you still have problems, contact your local Retailer or Approved Workshop.



Compass

HOW TO USE YOUR CARAVAN'S EQUIPMENT



PROTECT - AUTOWATCH ALARM SYSTEM

Manufactured by Autowatch, The system is designed to give years of trouble free operation. Made with only the highest quality components and using state of the art technology you can be assured that your caravan has the best electronic protection available.

Each caravan alarm is installed with a Passive Infrared Detector (PIR), a sensor that detects movement in the caravan and transmits a radio signal to the alarm module. If the alarm is on the siren will sound. A leg sensor, fully sealed against dust and water, will detect if the corner stabilising leg is being raised or lowered and transmits a coded radio signal to the alarm.

Additional sensors can be purchased from your retailer to enhance security.

See section below for operation or consult the manufacturers instructions provided in the Owners Information Pack.

Basic Operation Arming the System

- (i) Briefly press (large) arm/disarm button.
- (ii) Single chirp.
- (iii) Awning light illuminates for 30 seconds.
- (iv) Settling time of 15 seconds before responding to triggers.
- (v) Single intermittent flash of status LED (every 2 seconds).
- (vi) All sensors triggered will result in siren sounding for 30 seconds, or until reset by pressing the arm/disarm button.

Disarming the System

- (i) Briefly press the (large) arm/disarm button.
- (ii) Double chirp.
- (iii) Awning light illuminates briefly on and off and then on again for 30 seconds.
- (iv) LED off.

Panic Alarm

- (i) Press and hold the small panic button on the transmitter for two seconds.
- (ii) The siren will sound for thirty seconds, unless reset by pressing any of the transmitter buttons.

Emergency Disarm

Insert the touch-key briefly into the socket. The alarm will turn off.

Silent Arm and Disarm

- (i) Press the small button briefly followed by a press on the arm/disarm button.
- (ii) The alarm will arm/disarm without chirps.

Sensors

Each caravan alarm is installed with a Passive Infrared Detector (PIR) and a leg sensor. Additional sensors can be purchased from your dealer to enhance security.

Passive Infra Red Sensor

The wireless PIR sensor will detect movement in the caravan and transmit a radio signal to the alarm module, if the alarm is on the siren will sound.

Leg Sensor

The leg sensor will detect the corner stabilising leg being raised or lowered and transmit a radio signal to the alarm. The leg sensor is fully sealed against dust and water and has a battery life expectancy of three years. When the battery becomes exhausted, the sensor will need to be replaced.

Enhanced Features Arming The System In "At Home" Mode

In the 'at home' mode, any sensor that is programmed to be isolated, such as the PIR sensor will not trigger the alarm. Other sensors, such as the leg sensor, will trigger the siren. Arm as normal followed by a second press on the arm/disarm button within 2 seconds. Normal "on" tone followed by "at home" tone indicating isolation is active. Settling time of 15 seconds before responding to triggers. Armed in the isolation mode will be indicated by a double flash intermittently of the LED. The "at home" sensors will be isolated; other sensors will trigger the siren for 30 seconds.

Arming the System in Test Or Buzz Mode

In the buzz mode the siren will sound a short tone when a sensor is triggered instead of sounding for 30 seconds. It is advisable to test all the sensors.



AL-KO Trailer - Control

AL-KO Automatic Trailer Control is an electronic control system that reacts quickly to maintain the stability of the car and caravan. The system continually monitors the stability of the caravan during a journey and operates when an unstable condition is encountered. When AL-KO ATC activates, the driver will feel the vehicle being slowed down by the soft braking of the caravan.

AL-KO ATC LED OPERATION

Display Colour	ATC Condition	Diagnosis	What to do	Outcome	Status
Green	ATC Active	Everything OK			
Green Flashing	ATC Active	Self test incomplete	Drive forward to detect movement to complete self test and recheck LED	Green (Constant)	Ready for journey
Red	ATC Inactive	Possible to continue journey	Remove 12S or 13 pin plug and wait five seconds. Reconnect plug	Green	Ready for journey
				Red	ATC fault detected but can be driven
Red flashing	ATC has detected a fault	Do not continue with ATC connected	Remove 12S or 13 pin plug and wait five seconds Reconnect the plug.	Green	Ready for journey
				Red (flashing)	ATC fault detected cannot be driven. Remove pushrod

Flashing Green - Simply the ATC is waiting to detect movement. Drive a few metres and the light will change to green.

Flashing Red - To provide further explanation if the constant RED light is showing: There are a number of errors that the ATC logs and some are self repairable by the customer but some will require the ATC to be monitored by the diagnostic equipment that is available and the AL-KO service engineers are trained to use.

Whale Easi-Slide Socket

How to open the socket lid

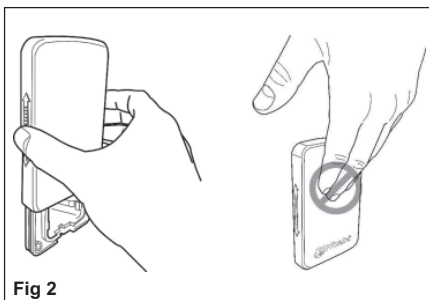
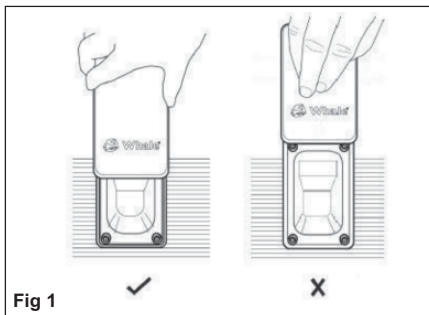

Safety Information

This appliance is **not** intended for use by persons (including children) with reduced physical, sensory or mental capabilities, or lack of experience and knowledge, unless they have been given supervision or instruction concerning use of the appliance by a person responsible for their safety.

- Children **must be** supervised to ensure that they do not play with the appliance.
- Any alteration to the appliance, misuse or use of non-original Whale parts may invalidate the warranty. Non observation of the installation and operating instructions will lead to cancellation of the warranty and exclusion of liability claims. It also becomes illegal to use the appliance if incorrectly installed, and in some countries may make it illegal to use the vehicle.

Additional Safety Information for Onboard Tank Fill, On Board Tank Fill +12v and Water In / Out Sockets (Where Applicable)

- For use in recreational vehicles with a typical water system pressurised up to 3 bar.
- When using the **Water In Socket**, Whale recommends that you keep the o-rings lubricated for easy and secure connection/removal of the plug to socket. Use a water-based lubricant such as silicone grease. **Please note: Do not use vaseline or vegetable oil to lubricate o-rings.**

Additional Safety Information for External BBQ Outlet Socket (Where Applicable)

Whale BBQ sockets including the gas hose connector must be installed and serviced by a Qualified Gas Engineer in accordance with these installation instructions and BS EN 1949-2011.

WARNING: Care must be taken when using the external BBQ outlet socket. NEVER barbeque next to an awning or tent.

WARNING: Only for use as an outlet point for gas, never connect a gas bottle directly to the outlet.

In the unlikely event of leaks in the gas system, or if there is a smell of gas:

- Extinguish all naked flames
- Switch off all appliances and do not operate any electrical switches
- Turn off all gas appliances
- Open windows and doors for ventilation
- Do not smoke
- Shut off gas connection
- Immediately ensure that the system is thoroughly checked by a **Qualified Gas Engineer**.
- Regularly inspect gas tap to ensure inside nozzle is free from debris, and gas connection to the rear has not been damaged.
- Supply to external appliance **should not be** less than 0.03 bar and not greater than 0.05 bar.



SECURITY

Theft deterrent, prevention and security of your touring caravan is taken very seriously at Elddis. That is why we have provided a combination of standard features and optional extras designed to deter and prevent thieves from stealing your property. And in the unlikely event that they should succeed, aid the identification, speedy recovery of your property and assist in the prosecution of the thief.

Caravan Theft

The theft of a caravan can occur in the most unlikely circumstances; from a motorway service area, even from an owner's driveway. Secure all windows and doors when your caravan is unoccupied, even if only for a short length of time.

Tracker Retrieve

Your caravan has been fitted with a Tracker.

A registration card with the Tracker details should be within your document wallet supplied with your caravan. We would recommend that this card is not kept in the caravan. To ensure the Tracker is registered, follow the instructions below.

Your dealer may have registered the caravan with TRACKER and confirmation sent to you via email.

If it has not been registered you can easily do it yourself.

Open the TRACKER registration portal at www.tracker.co.uk/elddis

TRACKER VLU and Caravan VIN

Numbers are matched and confirmed with the vehicle model

Enter Dealership name from dropdown menu

Enter customer details including email address

A confirmation email will be sent to the customer and a one year subscription will begin

TRACKER will contact customer towards the end of the one year subscription period with the options available.

or call TRACKER directly on 0845 604 6029

CRIS - THE CARAVAN REGISTRATION AND IDENTIFICATION SCHEME

CRiS is the Central Registration & Identification Scheme that issues touring caravan registration documents, equivalent to that of the V5 registration document issued by the DVLA for cars. CRiS was established in 1992 by The NCC and provides a method of registering the 'keeper' details of every tourer manufactured by NCC member companies to help prevent and detect caravan related crime.

Why register with CRiS?

- Safety
- Security
- Warranty

Did you know?

- You should not take a tourer abroad without a registration document. If you go abroad your CRiS registration certificate provides the necessary proof, required by the police and other authorities, that you are its registered keeper.
- If you need to make a claim on your insurance, CRiS can help speed up claims by providing details of your tourer and its purchase date to relevant parties.
- CRiS can help your tourer's manufacturer contact you in the event that there is any kind of product recall or fault that could affect the safety of your caravan.

For help, support and advice contact CRiS:

NCC CRiS Ltd

PO Box 445

Aldershot

GU11 9FS

Tel: 0203 282 1000

www.cris.co.uk



AL-KO SECURE WHEEL LOCK (Option)

You must register your key, should you fail to do this you will not be able to order a spare key or obtain lost or stolen keys.

This is how it works:

- On the Al-Ko Secure registration card you will find an exclusive security number.
- Please register your key by telephoning 0870 7576788 or 0044 1926 818500.
- You will be required to provide the chassis number of the caravan.
- You will need to provide us with a password and supply answers to three security questions.
- Make a note of your password and keep it in a safe place.
- Also keep your registration card safe.
- Take your registration card with you when you are travelling with the caravan.
- Always keep your registration card separate from the lock.

Safety Information

- Always secure the caravan against movement (chock the wheels, couple to towing vehicle).
- Never leave Secure parts (key, locking bolt, registration card) in the caravan.
- Always remove Al-Ko Secure before moving the caravan.
- After any attempt at theft has been made on a locked Al-Ko Secure, the caravan must be inspected in an Al-Ko Approved Service Workshop.
- Always keep the key in a safe place.
- Keep the lock set and registration card separate from the keys.
- The lock parts and key do not have a registration number, therefore keep the registration card in a safe place.
- Caravans with twin axles have two locks, keep each lock set in a separate place. The sets are not interchangeable!

Note: Read the operating instructions and act in accordance with them. Keep the operating instructions for general use. Follow the safety instructions as well as the warning information.

ASSEMBLY

We recommend the use of a side-lift jack for easier fitting of Al-Ko Secure when used on a twin axle caravan. (Order No. Al-Ko Jack Set 1389235).

- Align the wheel so that the receiver can be seen in the centre of the rim opening. DO NOT use the rim opening in which the tyre valve is fitted. (Fig. 1)
- Unscrew the plastic cap from the receiver and store in the tool kit box. (When Al-Ko Secure is not in use, always screw the plastic cap in place). (Fig. 2)
- Insert the locking bolt into the rim specific insert. (Fig. 3)
- Insert the locking bolt socket key. (Fig. 4)
- Line up the locking bolts and assembly with the receiver. (Fig. 5)
- Tighten the locking bolt socket using the wheel spanner provided (or torque wrench as shown) to wheel ratchet. (Fig. 6)
- Remove the locking bolt socket key. (Fig 7)
- Insert barrel lock. (Fig. 8)
- Hold the lock fast and lock. (Fig. 9)
- The Al-Ko Secure is now fitted. (Fig. 10)

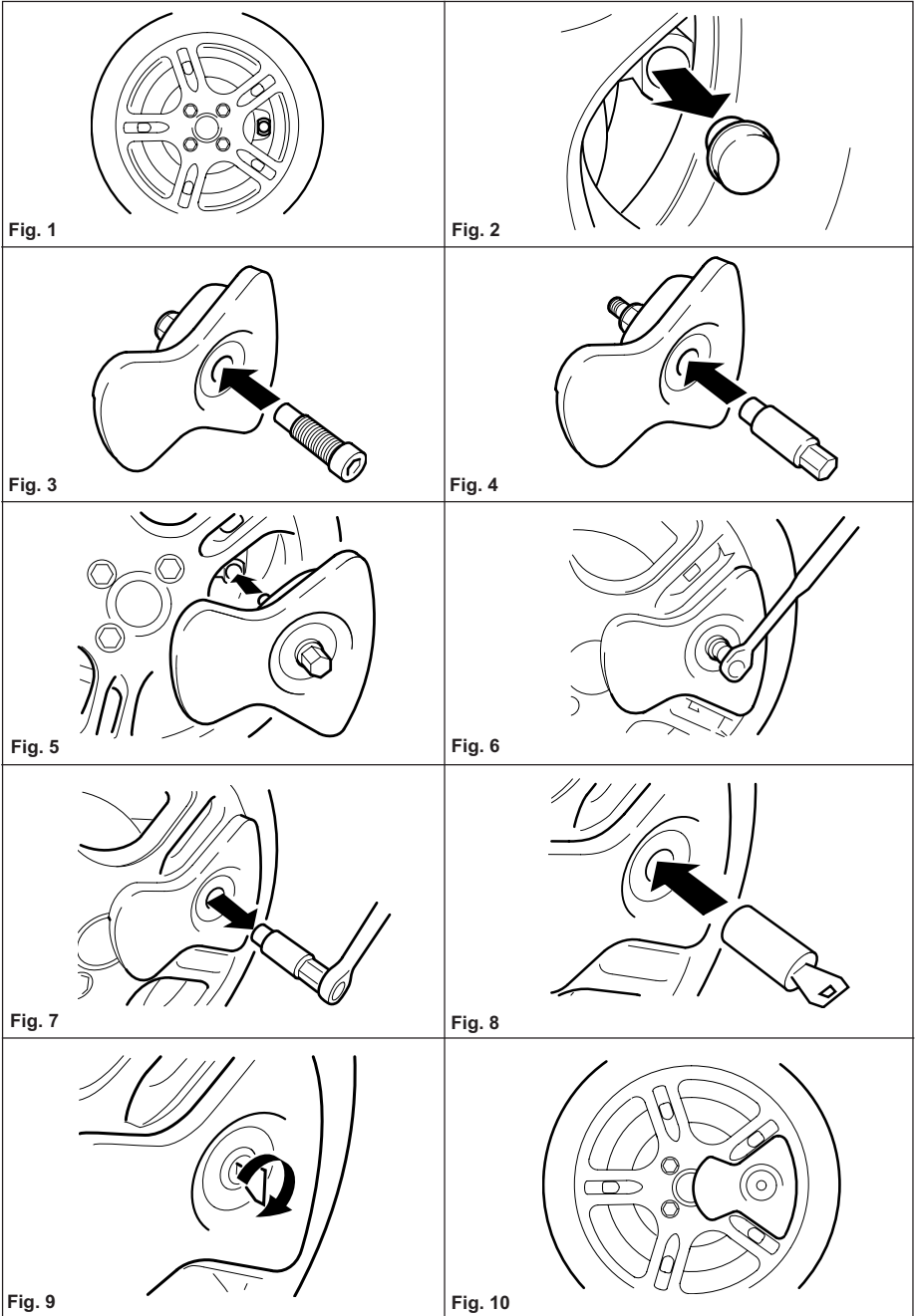



WINDOW & CHASSIS MARKING

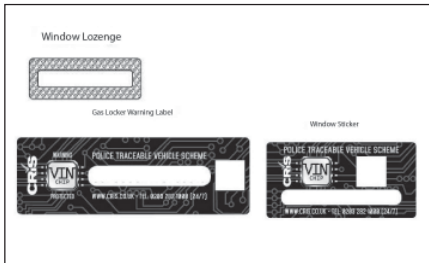

Your Touring Caravan Registration Document will include a 17 character VIN (Vehicle Identification Number), shown in the top right hand corner. This 17 character VIN will be die-stamped into the caravan chassis with a tamper evident label in the gas locker and a maximum of 10 tamper evident labels placed on the inside of all windows (with the exception of opaque windows). To protect yourself and your touring caravan, never leave the Registration Document in the caravan. For security reasons keep it in a safe place.

If you sell the caravan please follow the instructions on the Touring Caravan Registration Document.

Please note: If you do not receive a Touring Caravan Registration Document, lose it, or any of the details recorded are incorrect, please contact: CRIS - PO Box 445, Aldershot GU11 9FS. Telephone: 0203 2821000.

Spare windows labels can be found in your owners information pack for use if you ever need to order a replacement window.

ELECTRONIC TAGGING

In conjunction with the CriS registration scheme, all Elddis touring caravans are electronically tagged during manufacture for added security and to ease vehicle identification. The security tag containing the individual identity of your caravan is concealed within the caravan body and can only be read by using a special decoder.

Please Note: Your Local Police Can Obtain The Use Of A Decoder By Contacting C.R.I.S. on Telephone No. 0203 2821000.

ADDITIONAL SECURITY

Consider fitting any device which might deter or prevent intrusion by thieves. For example: A wheel lock will prevent towing of the caravan and removal of the wheel.

FREE CRIME PREVENTION advice about securing your caravan, protecting your valuables, property marking, either at home or whilst on site, can be obtained from the Crime Prevention Officer through your local Police Station.



CARE OF YOUR CARAVAN

This section of the guide is devoted to the care, cleaning and general preservation of your caravan in order to retain its showroom condition.

EXTERIOR CLEANING

Under no circumstances should an abrasive or harsh cleaner be used. It is strongly recommended that you do not use a pressure wash. Exterior body parts of the caravan are extremely durable and easy to clean. It is recommended you first wash off any heavy dirt and mud with cold water then use Autoglym products.

All the adhesives used to seal exterior components are mould resistant but not mould proof. In order to ensure that these adhesive beads are maintained in the best possible condition and that their appearance does not become unduly affected by mould growth, it is recommended that they are regularly washed and cleaned using a suitable proprietary caravan or car cleaning wash product.

CAUTION: The use of a pressure wash on your caravan is not recommended as it can lead to water entering the caravan via any of the external vents and could damage graphics.

WHEELS

Do not use acidic cleaning products on the wheel bolts.

GLASS FIBRE REINFORCED PLASTIC (GRP - WHERE APPLICABLE)

GRP components need to be washed, waxed and taken care of like a car. Chemicals and dirt can collect during storage, and the gel coat can be stained or marked when chemicals combine with rain or dew. Most stains or marks can be removed with Blue Diamond Black Streak remover, but more stubborn marks may require a (fine grit) rubbing compound such as Farcela G3.

To help keep your GRP components looking almost like new, it is wise to wash the parts monthly (or more frequently) using Autoglym products, but avoid using strong alkaline (e.g. trisodium phosphate) or acidic cleaners or abrasives. Waxing the components once or twice a year with a good grade paste wax will help to maintain the colour and finish.

ACRYLIC WINDOWS

Your caravan is fitted with shatter resistant acrylic windows. To preserve their clarity and unblemished transparency it is essential that the following cleaning instructions are strictly adhered to: Road grit, dust, sand, flies, bird droppings etc., should be washed off using plenty of cold water do not use a sponge to clean off heavy dirt deposits. Any remaining dirt should be washed off using a soft cloth and warm water.

Please note: Under NO circumstances should any abrasive cleaning agents, household detergents or proprietary cleaning fluids be used. Wash the window again using only cold water and dry off with chamois leather.

Please note: Should scratches appear on the acrylic windows these can often be removed with an acrylic polish, i.e. ICI Perspex polish. Gentle polishing with a liquid metal polish, i.e. Brasso may also have the desired effect - consult your retailer BEFORE attempting to remove any but the slightest scratch.

WINDOW BLINDS & FLYSCREENS

To clean the blinds and flyscreens, moisten a soft cloth or sponge with a small amount of water and mild soap suds and gently wipe dirt off. Allow to dry before retracting, failure to do this could result in mildew forming.

Pleated blinds where fitted should be cleaned using a soft brush and if necessary hoovered using a soft brush attachment on the device.

Winterisation/Storage

Please note: The blind/flyscreen should not be left in the down position when the caravan is not in use or throughout the winter as the memory of the mechanism may be lost.



ABS - A FRAME COVER, WHEEL SPATS & PANELS

To preserve the appearance of all ABS panels and fittings road grit, dust, sand, flies, bird droppings etc., should be washed off using plenty of cold water. Any remaining dirt should be washed off using a soft cloth and warm water. Under NO circumstances should any abrasive cleaning agents, household detergents or proprietary cleaning fluids be used. Wash the ABS material again using only cold water and dry off.

WARNING: Under no circumstances should alcohol, spirit or solvent-based liquids be used on GRP or ABS plastic panels as these substances may react with the material and cause visible damage.

INTERIOR WALLS

Your caravan interior walls will only require a wipe over with a damp cloth, using soap and water to keep them in a 'showroom' condition.

FURNITURE

Treat your caravan furniture as you would the furniture in your home. Polish wood surfaces sparingly with a good quality wax or spray polish. Use a damp cloth to clean melanate laminated surfaces.

COOKING EQUIPMENT

Caustic pastes, abrasive cleaning powders, coarse wire wool and hard implements will damage the surface.

SOFT FURNISHINGS

Carpets

What to do in the event of a spillage

A little common sense has to come into play here when a liquid spillage occurs it should first be blotted up immediately (never rub) using a clean absorbent cloth. White only kitchen towel, White tea towels or Terry towelling nappy type cloths are ideal for this purpose. (Something that colour is not going to come out of and add to the problems!)

1. Don't rub - blot with absorbent white cloth initially.
2. Rinse with cold water using a spray applicator bottle and the combination of a spray & blot technique will remove most spillages.
3. Use warm carpet shampoos if water does not rinse off the spillage allowing time for them to work before rinsing off.
4. Place a weighted absorbent cloth over the damp patch when you have cleaned the area to pull any materials out of the carpet that were not fully removed during cleaning to help prevent a stain occurring on the surface. Leave overnight or when dry remove.
5. If a stain containing colourant does occur that cannot be removed with shampoo try bleaching it off with 50% bleach 50% water solution.



Compass



6. If the stain is still present then call in the professional.
7. If the professional fails then contact us at www.StainClearCarpets.co.uk but ensure you have copies of your professional cleaning history invoices if over 2 years old and stain removal invoices for this claim ready.

Upholstery

Remove dust on a regular basis with your vacuum's upholstery or drape attachment. Try to avoid brushing fabric covers because that can damage the pile.

Only use an upholstery brush on the upholstery, never use any other type of brush to clean the upholstery as this may damage the pile. Avoid detergents which may damage the fabric's protection. Use a sponge or a clean white cloth but do not wash or rub the fabric. Leave to dry in normal conditions. These actions will not affect the Fire Retardant treatment of the fabric.

Heavy soiling will require professional cleaning. All fabrics will fade to some degree if exposed to direct sunlight.

Dyes from a number of sources, such as newspapers, jeans etc could stain your upholstery if placed on the upholstery when either the upholstery or other item is damp. It isn't always easy to avoid that from happening, however, proper ventilation can help. Try to keep pets off the upholstery and be careful of sharp objects such as belt buckles, toys and watch straps snagging the fabric. If snags do occur, carefully cut off the loose ends with scissors or tuck back in - do not pull them under any circumstances.

WINTERISATION AND STORAGE

Mattresses are made from fire retardant fabric and foam. Remove upholstery from the caravan and store somewhere dry and well ventilated. If upholstery is being left in situ store in an upright position away from the caravan walls, this will help air to circulate and prevent mildew occurring.

To aid air circulation leave fixed beds in the open position.

Try to keep your cushions away from direct sunlight.

Curtains

It is recommended that the curtains in your caravan are washed on a delicate cycle at 30°C. This will not damage the clip glides.

Shrinkage may be caused should you decide to dry clean your curtains.

Curtains should not be left closed during daytime otherwise some fading will be experienced.

SHOWER TRAYS, SHOWER ROOM AND WASH BASIN FITTINGS

Only clean your shower tray using soap and water. **Do not use** chemical based cleaning agents as this will attack the material.

CLEANING OF ALL TAPS

It is recommended that a non-abrasive damp cloth be used for cleaning the taps and showers.

Cleaning instructions for all chrome plated products – (taps, wastes, bathroom accessories, etc.)

Alcohol, solvents and solid detergents, liquids containing acid or aggressive solutions, anti-calcareous products, abrasive sponges or steel wool should absolutely be avoided since they could corrode in an irreparable way the outer surface of the products.



WATER CONTAINERS

- (i) All water remaining in any water container should be disposed of so that the container is empty.
- (ii) The outside of external water containers should be thoroughly cleansed and washed down to remove any dirt, dust or other contaminant. Water at a suitably hot temperature containing an appropriate detergent is recommended for this purpose. Water should then be put into the container, swirled round, then emptied out.
- (iii) All containers should then be totally filled with water containing an appropriate disinfectant / sterilising solution and allowed to stand for the recommended contact time.
- (iv) The solution should be emptied from the container.
- (v) The opening of any container should be cleaned thoroughly with an appropriate pre-prepared wipe impregnated with a disinfectant / sterilising solution.
- (vi) External containers should be inverted whilst stored overnight (if possible).
- (vii) Containers must be filled with mains water only and mains water only should be used for the above cleaning procedure.
- (viii) On no account should garden hoses be used to fill water tanks.

WATER SYSTEMS - STERILISATION

Clean the water system at the start and end of the season with sterilising fluid.

Please Note: It is recommended that for this operation the filter is removed as the fluid reduces the effectiveness of a new filter.

- (i) Drain down the system. (Open all taps to allow air in, enabling the system to drain quickly.) Including water heater drain tap.
- (ii) Remove any water filters fitted, and replace with a short length of hose or empty filter cartridge (this will ensure the filter is not affected by the disinfectant / sterilising solution).
- (iii) Fill the system by using the pump with a disinfectant / sterilising solution. (Check that the solution at full strength appears at all taps/showers). Allow to stand for the recommended period of time.
- (iv) Drain the system down completely.
- (v) Thoroughly clean the outside of all taps/ connectors with a cloth soaked in the disinfectant / sterilising solution.
- (vi) Flush the system through with clean drinking water until no traces of disinfectant / sterilising solution can be detected at any tap.
- (vii) After sterilising the system at the start of the season it is recommended that a new inline water filter cartridge be fitted. (Located on the cold feed to the kitchen tap).

Please note: Suitable sterilising chemicals are available from your Elddis Retailer, accessory shop, chemists, or home-brew shops. It is not, however, recommended to use bleach or sodium met bisulphide.

THETFORD TOILET

WARNINGS

- **Cold Weather Use - to prevent freezing during cold weather use, add antifreeze to the toilet system fresh water tank. Use a non-toxic (propylene glycol) type of antifreeze. Refer to chart on container to obtain level of protection.**
- **Warmer weather or longer intervals between emptying the waste tank may require additional toilet fluid. Use only Thetford toilet fluid to achieve the best results.**

CAUTIONS

- Never add toilet fluid directly into toilet bowl.
- Do not use strong household detergents or cleaners that contain chlorine, solvents or acid contents.
- High Altitude and Hot Weather Use - with large temperature differences and changing heights during towing, over pressure can start to build up in the waste holding tank, causing contents to splash upward upon opening the valve blade if opened too fast.

CHASSIS MOUNTED SPARE WHEEL CARRIER

To gain access to your spare wheel lift the spare wheel carrier up and lift up the locking mechanism. Then move the mechanism to the horizontal position and the spare wheel carrier will be free to move over the mechanism and allow the spare wheel to drop to the floor to be removed.

To replace the spare wheel simply reverse the operation making sure that the quick release mechanism has been fully pushed down to create a positive lock. The carrier is of extra strong, lightweight construction and zinc plated for all weather protection. It is easy to fit and accepts all conventional wheel sizes.

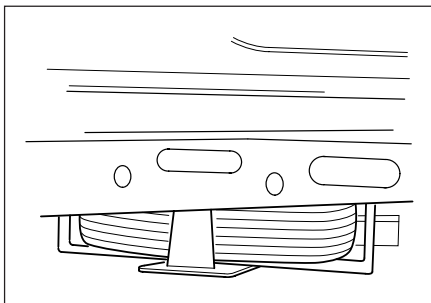

TYRES

Please refer to your Technical Data sheet provided with your customer information pack for information regarding tyre pressures and tyre sizes.

Pressures

It is customary for manufacturers to mark tyres with load and inflation data. This information relates to the use of the tyre on cars. It is dangerous to drive with under inflated tyres. The pressures (cold) recommended by the manufacturers should be regarded as a minimum. Pressure checks, including those on the spare tyre, should be made with the tyres cold and using an accurate pressure gauge. The checks should be carried out before each journey and at regular intervals during storage.

Tyre Wear and Damage

The legal requirements for tread depth on motor vehicle tyres apply also to caravans. A redundant tyre must be replaced by one of the same size and load index. Wheels should be changed round occasionally to equal wear and prolong the life of the tyres. A tyre should be renewed if a blister, rupture or cut exposing the casing is detected. If the tyre has suffered a violent impact e.g. against a kerb, it should be examined by a specialist as soon as possible.

CHANGING A WHEEL

Whenever road wheels are removed and refitted, they must be tightened using a calibrated Torque Wrench set to 102Nm for steel wheels and 130Nm for alloy wheels.

Only use the wheel bolts supplied with your caravan. If you need to replace these bolts you should obtain bolts from an approved Elddis Retailer.

The bolt fixings should be tightened in the sequence shown in the diagram below. Do NOT simply tighten clockwise or anti clockwise. Remember to over tighten is just as dangerous as to under-tighten, as this can distort the wheel rims. Avoid the use of power wrenches. Wheel bolts should NEVER be lubricated.

Alloy wheel bolts can be used to fit the steel wheel until the alloy wheel is ready for refitting.

Never use steel wheel bolts to fit an Alloy wheel.

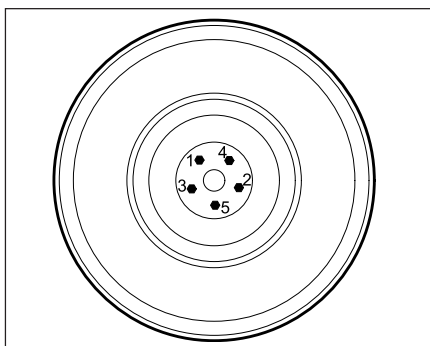



The corner steadies must not be used to jack up the caravan. They can be lowered to touch the ground only as a safety measure to stabilise the caravan.

- (i) Apply the handbrake fully as for parking. Do not forget to give the caravan a slight rearwards push to stop the reversing lever collapsing.
- (ii) Slacken off the wheel bolts on the wheel to be changed.
- (iii) Ensure all corner steadies are in the up position before commencing jacking of the caravan.
- (iv) With a suitable jack, jack up the caravan under either the axle tube, the axle mounting plate or designated jacking point.

Please note: Do Not Use The Chassis As A Jacking Point. If there is lack of ground clearance because of a flat tyre, gently move the caravan onto some ramping boards.

- (v) Support the weight of the caravan with the jack and for added safety lower the front and rear corner steadies on the side of the flat tyre. Then remove the ramping boards.
- (vi) Remove the wheel bolts and remove the wheel.
- (vii) Before fitting the wheel, examine it for distortion or other damage. Ensure that all mating surfaces are clean and dry, including bolt/nut seats.

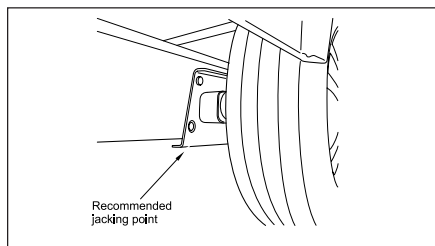

Please note: Always Use the Correct Bolts to Secure the Wheel - Check with the dealer if unsure.

Please note: A corner steady brace is not to be used for the next step.

- (viii) Insert the wheels bolts.
- (ix) After the bolts have been screwed in as far as possible by hand, each bolt should

be tightened gradually in sequence. Do not over tighten at this point as the final tightening should be done with a calibrated torque wrench. The wheels of the caravan will not rotate during tightening as they are held rigid by the wheel hub brake unit.

- (x) Raise the corner steadies.
- (xi) Lower the caravan to the ground.
- (xii) The wheel bolts should be tightened ensuring that the torque is applied evenly around the wheel. Using a suitable torque wrench, sequentially tighten the steel bolts to a torque of 102Nm for steel wheels and 130Nm for alloy wheels following the sequence stated above.

IMPORTANT

- **The torque settings should be re-checked after 50 km (30 miles).**
- **Do not use acidic cleaning products on the wheel bolts.**
- **Do not loosen the wheel bolts to carry out this operation whilst the road wheel is supporting the weight of the caravan.**
- **Wheel bolts should NEVER be lubricated.**
- **NB: If you upgrade from steel to alloy wheels you must ensure you use the correct bolts for the new wheel.**

JACKING

Under no circumstances should the corner steadies be used to jack up the caravan. When it is necessary to jack up, use a bottle, screw, trolley or scissor type jack, one with an axle shaped head is recommended.

Place the jack plate under the axle tube as near as possible to the main longitudinal member. The maximum mass which the jockey wheel and its clamping mechanism are capable of withstanding is as per the technical data sheet provided with the vehicle.

LUBRICATION

- Lubricate the Jockey Wheel spline
- Lightly oil the wheel axle and screw thread.
- Lubricate the Brake Linkage
- Lightly oil all moving parts.
- Lubricate the Corner Steadies
- Lightly oil the screw and pivot pins.



THE ALKO CARAVAN CHASSIS

Chassis members

The recommended tow vehicle coupling height is 350-420mm from the ground to the centre of the ball when the vehicle is fully laden.

Manufactured from high quality steel, the chassis has extra deep sections to provide strength at points of maximum stress. Large elongated holes are punched in the longitudinal and towbar, ('A' frame) members, to reduce weight to a minimum. Each hole incorporates a return flange to maintain the required strength and provide rigidity in the extra deep sections.

The chassis frame is of a bolted construction which, should the need arise, allows replacement of individual parts.

The chassis is Hot Dipped Galvanised. This is regarded as one of the best forms of corrosion protection. It does however require minimal maintenance in certain circumstances.

When new the chassis is of a bright and shining appearance. As the galvanising cures during the initial 2 to 3 month period, this will gradually change to a medium to dark grey colour. This grey finish is the ideal, giving the correct protective coating. During this curing period the surface should be protected to avoid possible wet storage stain, in the form of a soft, light coloured, porous, oxidation layer. If the chassis members are in contact with any salt deposits from roads this should immediately be washed off. Salt attracts moisture allowing the surfaces to remain wet, this prevents curing and also allows formation of wet storage stain.

It is recommended that the chassis be washed on an annual basis (particularly after winter usage) to avoid undesirable build up of salt and dirt deposits.

The galvanised chassis should not be painted or subjected to any other protective treatment.

Should the galvanising become superficially damaged exposing the steel core, this should be cleaned and treated with a cold galvanising spray obtainable from vehicle accessory outlets.

Damage to chassis members through impact etc. must not be straightened or welded.

Damaged chassis members must be replaced.

Drilling or welding of parts or accessories

This chassis is designed and built to precise tolerances and must not be drilled or welded.

Independent suspension

The ALKO rubber suspension is designed and developed to suit all types of road conditions and is maintenance free. Three rubber elements are contained within a hexagonal axle tube. These provide suspension and have inherent damping characteristics. (Only the hubs and wheel brakes require attention - see axle booklet Part No. 580458).

Coupling head

The ball couplings are entirely automatic in operation and designed for one hand operation to suit the 50mm international ball recommended by the British Standards Institution, National Caravan Council and the Society of Motor Manufacturers and Traders.

Uncoupling

Having lowered the jockey wheel to the ground, operate the handle as previously described. Lift the coupling clear of the towing ball either manually or by operating the telescopic jockey wheel.

Brake drum/hub assembly

The Euro Axle fitted to your caravan comes complete with maintenance-free wheel bearings greased and serviced for life. Adjustment is not required during the design life of the sealed bearing (100,000 km).

CAUTION: If replacement of the brake drum or shoes is required, this must be carried out by authorised AL-KO Service Centres. Specialist tools and equipment are required. The rear hexagonal bolt covered by a black plastic cover must NEVER be touched.



Operating instructions

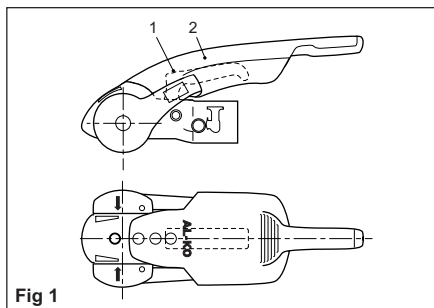
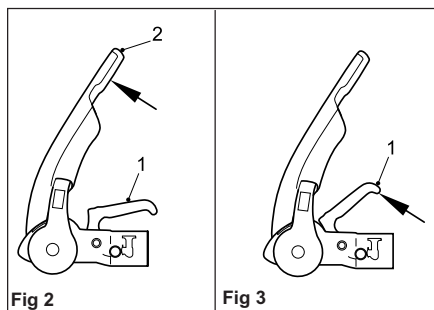

Fig 1
Coupling handle (Fig. 1/Item 1), Stabiliser Lever (Fig. 1/Item 2)

The Stabiliser lever (Fig. 2/Item 2) must be in the uppermost position (open).



Coupling

- Pull the coupling handle (Fig. 3/Item 1) up in the direction of arrow. The coupling mechanism has an open position ie. as long as the AKS 3004 is not placed on the ball, the handle will remain open. Put the opened coupling onto the clean towball. The handle must now make an audible click and return to the flat position.

WARNING: The coupling is correctly engaged when the green edge of the safety indicator button is visible (Fig. 4/ Item 3).

WARNING: Always ensure that the jockey wheel is fully raised and secure before commencing any journey.

Stabiliser Unit:

- To operate the Stabiliser (once coupled to the towball), simple press the stabiliser lever down as far as it will go (Fig. 4/Item 2).

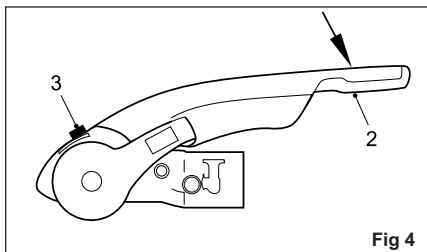

Fig 4

Uncoupling

- Pull the stabiliser lever handle up as far as it will go, open the coupling handle and lift the AKS 3004 from the towball. With larger nose loads, coupling and uncoupling can be made easier by using the friction wheel to assist lifting.

The friction pads are pressed against the towball and hence generate a stabilising/ damping force. These pads are therefore subject to wear over time, however they will have a long service life (circa. 30,000 Miles), provided they are well maintained and kept free of grease/dirt.

Checking the efficiency of the left/right friction pads:

- 1) Couple up AKS 3004
- 2) Open Stabiliser lever (Fig. 5/Item1).

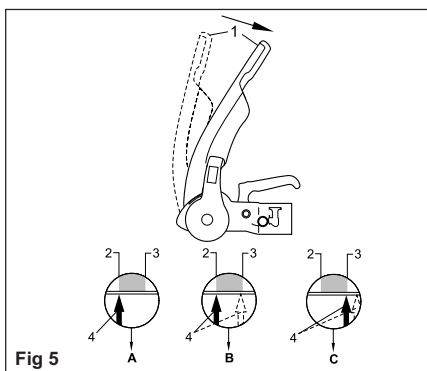

Fig 5

- 3) Close Stabiliser lever until resistance is felt (ie friction pads are in contact with the ball but not yet under pressure).
- 4) If the arrow on the arm (Fig. 5/Item 4) is before or on the marked area (Fig. 5/Item 2) the friction pads are still as new (See A)
- 5) The arrow on the arm should lie between the marked area on the soft dock (See B)
- 6) If the arrow on the plate reaches or passes the marked area on the soft dock then the friction pads need replacing (See C).

It is not necessary to adjust the friction pads

Manoeuvring operation

For easier manoeuvring (on campsites etc), pull the stabiliser lever to the 'up' position.

Please do not use the stabiliser lever as an manoeuvring handle. Please use the handles on the Caravan or fit the AL-KO manoeuvring handle to your jockey wheel (available separately).

- 1) During opening or closing, the AKS must only be operated by one person.
- 2) Press stabiliser lever down by hand force only DO NOT use your foot or an extension bar, this will damage the components (Fig. 6).
- 3) When opening or closing the stabiliser lever, please ensure your hand does not touch the coupling handle - you may accidentally trap your fingers! (Fig. 6).

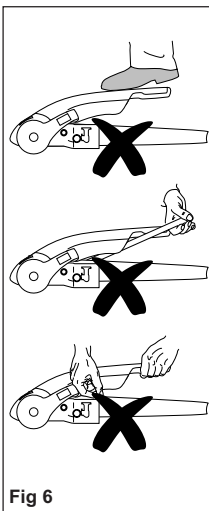

Fig 6

Noises whilst driving

As a rule, the friction pads of the AKS 3004 do not make a noise during driving. Any clicking, creaking or squeaking noises that do arise may be due to the following:

- a) Foreign bodies or dirt between the friction pad and tow ball.
- b) Dry operation of the drawshaft inside the overrun device.
- c) A detachable towball which has too much play in the locking mechanism.

Remedial Action

- a) Clean the tow ball and friction pads by lightly rubbing the surface (100-120 grit emery paper)
- b) Lubricate the drawshaft sleeve via the grease nipples. In addition, push the gaiter forward and grease (DIN 51 825 KTA 3K) the exposed part of the shaft (Fig. 7).
- c) Visit a specialist workshop to have the ball holding area checked for damage and the locking mechanism for function. If necessary, change the towball.

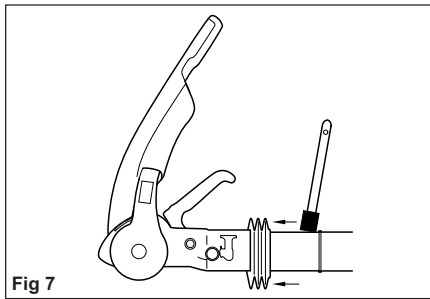

Fig 7

Storing

To reduce the possibility of contamination of component parts of the AKS 3004 the stabilising handle should be closed.

Towing ball

The automobile towing ball should measure 50mm maximum and 49mm minimum diameter (DIN 74058). If the ball is below 49mm diameter it should be replaced immediately.



Overrunning device

The device housing is packed with grease on assembly, but will require periodic maintenance to ensure smooth operation of the braking system.

- 1) Regrease the shaft bearings via the grease nipples provided at 3000 mile intervals, and before storage.
- 2) Ensure correct functioning of all pivot pins and levers and oil regularly.
- 3) Ensure correct functioning of handbrake ratchet and oil regularly.

Jockey wheel

Lubricate wheel and screw thread periodically with grease.

Brake linkage

All moving parts should be lubricated periodically to ensure their satisfactory operation.

Corner steadies

The screw and pivot pins should be lubricated periodically to ensure their satisfactory operation.

Braking system adjustment

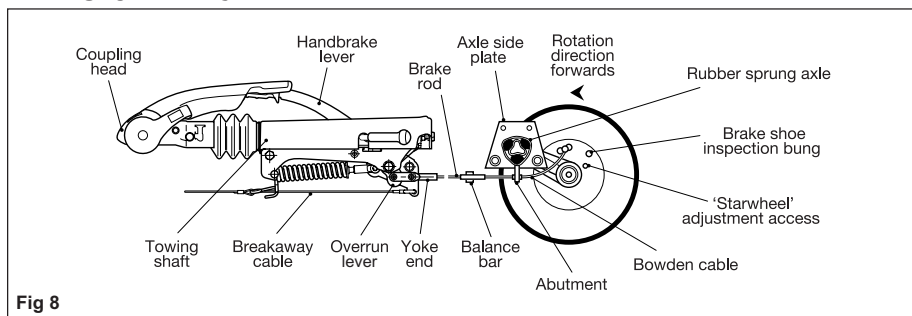

Fig 8

(At 500 miles, then every 3,000 miles or 1 year)

- Ensure the towing shaft with coupling heads is pulled fully forward (Fig. 8).
- Release the handbrake to the fully off position. If the handbrake will not go down the whole way because of the fairing or any other obstruction; then the fairing must be cut away and/or the obstruction removed to achieve this desired position. It will not be possible to set up the braking system properly when the handbrake is not in the fully off position (Fig. 8).
- Jack up one side of the caravan (see Jack Operation Instructions).
- Remove the inner plastic bung from the backplate to expose the 'starwheel' adjuster access (Figs. 8 & 9).
- Always rotating the road wheel in the forward direction - never backwards; adjust the starwheel with a suitable screwdriver, in the direction of the arrow

embossed on the backplate until there is resistance in the wheel rotation (Fig. 9).

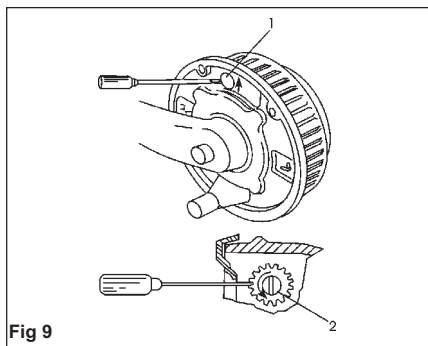

Fig 9

- Slacken off the starwheel adjuster until the road wheel turns freely in the forward direction (Fig. 9).
- Check the adjustment at the end of the brake cable where it is secured to the abutment (bracket) welded to the centre of the axle. When the inner cable is

pulled out it should extend between 5 and 8 mm (Fig. 8). (On tandem axles a double abutment is fitted to the front axle only).

- Repeat for other wheel or wheels.
- On tandem axles the brake cables from the rear axle should pass over this axle and cross over each other before being connected to the abutment on the front axle.
- Ensure the balance bar (compensation) is being pulled evenly. This bar (double on tandem axles) should always be paralleled with the axle tube when pulled (Figs. 8 & 10). Adjust M8 lock and ball nuts, if necessary, to achieve correct parallel position (Fig. 10).
- Check the brake rod support bracket, (fixed to the floor) is supporting the brake rod evenly. The brake rod must always run straight, never bent or curved under any fittings. On tandem axles, using the double balance bar, a brake rod support tube (Part No. 228827) must always be fitted on the end of the brake rod, passing through the centre aperture on the abutment.
- Remove the slack in the brake rod by adjusting the long ball nut, rear of the balance bar, ensuring the overrun lever makes contact with the end of the towing shaft.
- Over adjustment to the long ball nut (Fig 10), could induce movement of the inner brake cable, reducing the effective clearance of the brake shoes. If the overrun lever will not make contact, it is possible the two lock nuts, forward of the spring cylinder, are incorrectly adjusted. Loosen the nuts and adjust the brake rod as above (Figs 8 & 10).
- Adjust the two locking nuts, forward of the spring cylinder (Fig. 10), (on some chassis a single Nyloc nut is used) to

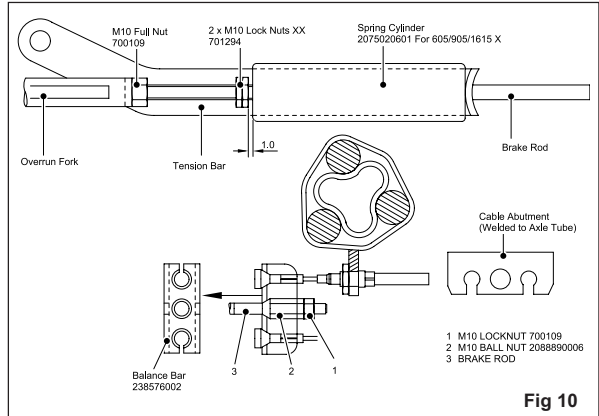

Fig 10

give 1mm of clearance on the spring cylinder. This cylinder (the energy store for the handbrake operation) must be able to rotate only, not slide on the brake rod.

(See Fig. 10). If the overrun assembly is fitted with a gas strut handbrake then no spring cylinder is fitted - therefore ignore this paragraph).

- Correct adjustment of the linkage is checked by operating the handbrake lever so that when the second or third tooth is engaged, a slight braking force is felt on the road wheels.
- Over adjustment of either the wheel brakes or linkage, will result in difficult reversing causing the wheels to 'lock-up'.
- When parking, the handbrake lever must always be engaged into the fully upright position (90°). This is to compress the spring within the spring cylinder and thereby create an energy store, which will automatically engage the brakes further should the caravan move.

If difficulty is experienced in this operation, try easing the caravan backwards with one hand while engaging the handbrake fully with the other. This manoeuvre should not be attempted on a rearwards facing slope. In this case wheel chocks should be used combined with the handbrake.



- Finally, if the alloy road wheels have been removed, re-tighten using a calibrated Torque Wrench to 130 Nm (Newton Metres) (96 lb-ft) - on all M12 wheel bolts - in sequence, i.e. North, South, East, West not clock or anticlockwise.

WARNING: The torque settings should be rechecked after 50km / 30 miles. Wheel bolts should never be lubricated.

In order to operate the ALKO braking system correctly adequate traction of caravan wheels is required when reversing. Therefore surface conditions that would result in a lack of traction should be avoided. Example: Peas, shingle/loose gravel.

Care should be taken when traversing ramps or other obstacles in order to prevent damage to the caravan under gear. When approaching such obstacles reduce towing speed appropriately.

Chassis Lubrication Points

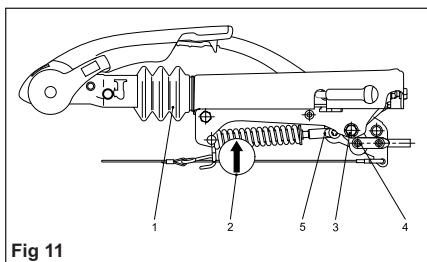

Fig 11

1. Grease the drawbar in the area of the bellows.
2. Grease the bearing bush through the grease nipples on the housing and the cartridge.
3. Grease the pivot bolt of the overrun lever and handbrake levers through the grease nipple.
4. Grease the joint of the brake rod and fitting.
5. Oil the joints of the spring cylinder in the handbrake lever.

Lubricant type: Multi-purpose grease to DIN 51825 KTA 3K4.



STORAGE

LONG TERM & WINTER STORAGE

If the caravan is to be stored for any length of time, especially over the winter period, the following operations are recommended:

- (i) Ensure all windows, roof lights, habitation and exterior locker doors are closed firmly and locked.
- (ii) Remove all soft furnishings which could be affected by damp conditions.
- (iii) Clean the caravan inside and out as detailed in the previous section.
- (iv) Drain the water system.
- (v) For winter storage and to prevent frost damage all taps must be left in open position. For those caravans with lift up taps please ensure the taps are left in the central position.
- (vi) All blinds and flyscreens should be left in the retracted position. Check all fixed ventilation apertures are not obstructed.
- (vii) Ensure that the refrigerator/freezer compartment doors are left open during storage.
- (viii) Check that the site you have chosen to store the caravan is open, fairly high and dry and if possible not exposed to gales etc. If this proves impossible it is recommended that the caravan chassis is anchored to the ground.
- (ix) Jack up the caravan (use bottle or screw jack, do NOT use the corner steadies) so that the wheels are clear of the ground.
- (x) Support the caravan axle with wooden blocks, axle stands or similar so that when the jacks are removed the wheels remain clear of the ground. Lower the corner steadies to level the caravan. Cover the tyres to prevent deterioration. Release the handbrake.
- (xi) Security: Lowering the corner steadies and removing the wheels will reduce the risk of caravan theft.
- (xii) The hitch head should be checked to see that it is fully extended and that there is no load on the braking system.

- (xiii) It is recommended that you place a bowl of salt within your caravan to absorb any moisture during the winter months.

CARAVAN COVERS

Caravan covers may be used to protect your new Eddis caravan provided that the cover used is of a breathable type.

Lower the TV antenna and ensure the cover is well tied down to avoid the cover being punctured.

Your caravan must be ventilated every 4 to 6 weeks if it is to be stored with a cover in place.

POWER DRAIN

Ensure that the leisure battery is fully charged before placing the vehicle into storage.

Once in storage check the battery state every 2 months, if the terminal voltage drops below 12.07V then re-charging is necessary.

Charging should be carried out in a cool, dry, well ventilated area.

Do not place the battery onto cold surfaces such as concrete as this will affect the battery's ability to charge.

This will depend on your leisure battery's capacity, age and state of charge.

Should the caravan be stored for a prolonged period of time it is strongly recommended that the caravan is fully serviced before the commencement of use. Your retailer will ensure that your caravan is safe, secure and ready for your enjoyment.



CARAVAN WARRANTY COVER

Introduction

At Elddis we are confident that our new caravans are engineered using the latest manufacturing techniques and advanced materials technology ensuring that, when buying one of our products, you are buying the very best. We extend this philosophy to our customers by offering long term peace of mind and reassurance through our extensive warranty cover.

Your warranty cover commences on the day your new caravan is purchased and comprises two key elements:

1. Three year manufacturer's warranty
2. Ten year body integrity warranty

Scope

This applies to all new products and is a guide intended to give a brief overview of the warranty terms applicable to your vehicle.

Conditions of use

Your new caravan has been designed as a leisure vehicle only and the warranty will not be given if the vehicle is used under the following circumstances.

- Used for hire
- Used as a permanent residence
- Towed with a commercial vehicle with a gross weight in excess of 3500kgs
- Used for racing or time trials
- Damage resulting from freezing, accident or fire damage

Exclusions

- No liability will be accepted for fair wear and tear, including mould or discolouration of adhesive. Damage including rodent damage, wilful damage or negligence from abnormal working conditions will not be covered.
- Condensation is not covered under the warranty agreement.

Three year manufacturer's warranty

Year 1 warranty - Covers all original components, forming part of the original product specification excluding normal wear and tear e.g. tyres

Year 2 and 3 warranty – Covers all original components, forming part of the original product specification, excluding the following items:

- Normal wear and tear and servicable components
- Microwaves
- Batteries
- Windows and glass
- All soft furnishings including mattresses (2-year warranty cover)
- Entertainment equipment
- LED lights
- All panels and plastic products
- Minor adjustments
- Serviceable chassis parts
- Ironmongery and corrosion of metallic components
- Electrical connections
- Floor coverings

We would recommend that customers have their vehicle serviced on or before the due date to ensure that all warrantable parts are identified before the expiry of the component.

Ten year body integrity warranty

Elddis products are covered against water ingress manufacturing defects for 10 years from the original date of purchase of a new product. (6 years for subsequent owners from the 1st owners original date of purchase).



Reporting a fault

In the unlikely event that you experience a problem with your caravan please contact your retailer.

It is with the retailer that your contract of sale exists and consequently they have the responsibility to ensure any complaints and warranty issues are addressed. Any Elddis approved Retailer / Service Centre are able to undertake any warrantable work at their convenience or discretion, but are not obliged to do so, if the vehicle was not purchased from them.

All Elddis products are classed as portable and therefore all work under warranty requires the caravan to be delivered and collected from the approved chosen Elddis agent.

The cost of transporting the caravan by any means to and from the place of repair is the responsibility of the owner.

In order to comply with the terms of the above cover the following conditions must be met.

Conditions attached to the warranty cover

- You must retain the original sale invoice for the caravan.
- All new caravans must be registered with Elddis within 6 weeks of purchase. Your retailer can forward this information to us. Please keep us informed of any name or address changes by using the Notification of Change to Name and Address form.
- The caravan must have an annual service and damp check carried out by an Elddis approved Retailer / Service Centre or NCC Approved workshop or NCC equivalent standard as set out in this handbook. Original invoices, service checklists and damp reports must be retained as proof that the annual services have been carried out in accordance with our warranty terms.

• Service intervals:

- a) In years 1, 2, and 4 through to 9 the service must be completed no more than 60 days either side of the anniversary of the date of purchase.
- b) In Years 3 and 10 the service must be completed no more than 60 days on or before the anniversary of the date of purchase and must not exceed this date.
- c) For second owners the service in years 3 and 6 must be completed no more than 60 days on or before the anniversary of the original date of purchase. This date must not be exceeded.
- d) No service interval should exceed 14 months.
- e) **Failure to service the vehicle within the specified time limits will invalidate your warranty.**

We would recommend that you have your service carried out by an Elddis Approved Retailer/Service Centre, who are able to assist you should warranty work be required. Should you choose to have your service carried out by a non Elddis Approved agent, an additional charge may be payable by the customer to cover the second inspection.

- We would recommend that you have your service carried out by an Elddis Approved Retailer/Service Centre, who are able to assist you should warranty work be required. Should you choose to have your service carried out by a non Elddis Approved agent, an additional charge may be payable by the customer to cover the second inspection.
- The caravan must be made available for repair within 6 weeks of the date of inspection for the purpose of carrying out the repair work.

Elddis reserves the right to inspect the vehicle before work commences. Failure to do this may invalidate your claim.

Warranty work may only be undertaken by an Elddis Approved Retailer/Service Centre.



- Eddis will pay the costs of remedial work to the repairer, only after approved work has been carried out. The cost of transporting, towing or moving the caravan by any means to or from the place of repair is the responsibility of the owner.
- The Policy is not retrospective and is applicable to 2012 model year caravans onwards.
- No liability will be accepted for any consequential loss, damage, costs, expenses or other claims for compensation arising which were not reasonably foreseeable by both parties when the caravan was originally purchased.
- No alteration may be made to the original construction.
- In the event of a dispute an arbitrator may be appointed, this is a discretionary service offered by us as appropriate. Should we deem it necessary to appoint an independent arbitrator, you may be required to pay a £250 deposit in advance of the inspection. If the arbitrator finds in favour of the customer then the deposit will be returned, otherwise the customer will lose their deposit.

Eddis reserve the right to inspect the caravan at any time.

Mains electrics

It is recommended that you have your mains electrics system inspected by a NICEIC approved contractor every 3 years.

Transfer of ownership

If you purchase this vehicle as a used vehicle it may be possible to transfer the unexpired term of the warranty cover (up to a maximum of six years commencing at the original date of purchase from the first owner) and is as follows:

1. Three year manufacturer's warranty
2. A maximum of six years' body integrity warranty

The warranty is subject to the usual terms and conditions' set out in the handbook and is only transferable on payment of a £50

administration fee. Full documentary evidence that the caravan has been serviced annually should be provided at the time of transfer, in accordance with the terms and conditions of the warranty stated in the handbook. Transfer of ownership must be completed within three months of change of legal ownership. Please complete the Notification of Change of Ownership form in your handbook. Failure to do this will negate the remaining warranty.

This warranty does not affect the purchaser's statutory rights. The warranty shall be governed and construed in accordance with the laws of England and the parties irrevocably submit to the exclusive jurisdiction of the courts of England.

For second owners the service in years 3 and 6 must be completed on or up to 60 days before the anniversary of the first owners date of purchase and must not exceed this date.

NON WARRANTY REPAIRS

Should you require any replacement parts for your caravan it is necessary that you contact the Retailer from whom you purchased the caravan or any Eddis approved Service Centre and give the following information, which will help in identifying the required component:

- (i) Model and make of caravan
- (ii) VIN number
- (iii) Description of required part
- (iv) Photograph, size or diagram of required part

Please note: All parts must be ordered and supplied through an approved Retailer/ Service Centre.



Compass

WARRANTY



REMEDIAL WORK

Elddis, together with its suppliers is continually undertaking extensive research into testing, remedial work procedures and materials such as structural bonding adhesives, gaskets and tapes. Therefore, if for any reason your new caravan is damaged or requires remedial work then we would recommend an approved Elddis Retailer or Service Centre should undertake such work.

All such work must be undertaken using only approved Elddis genuine parts, recommended structural bonding adhesive and following Elddis procedures. Elddis will also undertake to supply certain specialist repairers with the necessary spare parts. In this case, your selected repairer must contact the PARTS DEPARTMENT with all enquiries.



CARAVAN CONSTRUCTION - MAIN COMPONENTS

The following is a brief description of the main components used in your caravan. More comprehensive descriptions can be found in the equipment manufacturers literature held in the Owner's Information Pack.

ALKO CHASSIS

Manufactured from high quality steel, the chassis has extra deep sections to provide strength at points of maximum stress. Large elongated holes are punched in the longitudinal and towbar, ('A' frame) members, to reduce weight to a minimum. Each hole incorporates a return flange to maintain the required strength and provide rigidity in the extra deep sections.

The chassis frame is of a bolted construction which, should the need arise, allows replacement of individual parts.

BRAKING SYSTEM

The Braking System comprises a rod operated overrunning device with expander mechanism and adjuster box. An automatic reversing system with a spring loaded reverse lever is attached to the adjuster box. The system also incorporates a link device, which gives added safety to the handbrake operation when parking on a reverse slope or steep hill. Brake adjustment instructions are given in the maintenance section of this guide.

SOLID CONSTRUCTION BODY SHELL

Elddis Caravan Bodies are constructed from the highest quality materials. The fully insulated floor is a constructed timber frame with plywood internal floor and a GRP underskin for added water resistance and insulation laminated together for strength. The walls comprise an insulated foam sandwich having pre-coated aluminium exterior surface and vinyl coated plywood internal finish. Wooded framing is positioned within the sandwich to add strength. The latest technology is used to produce the extremely well insulated and robust, yet lightweight sections.

WINDOWS

Windows are all of a double glazed acrylic construction and the door frame is extruded aluminium.

INSULATION

Elddis caravans are built to comply with grade 3 thermal insulation in accordance with the European Standard BSEN 1645 part 1. This states that an average temperature difference of at least 35°C between the inside and outside temperatures should be achieved when the outside temperature is -15°C and an internal temperature of 20°C.

FRONT PANEL AND GAS BOTTLE LOCKER DOOR

The front panel and gas locker door are constructed from ABS plastic for strength and lightness.

The gas bottle compartment is primarily used for the storage of the gas bottle and is not intended to be sealed water tight to the exterior of the vehicle.

AWNING CHANNEL

Each caravan is fitted, as standard, with an awning channel as an integral part of the near- and off-side aluminium roof and body side moulding. We only recommend awning skirts with suction cup fasteners.

WIRING DIAGRAM - CAMINO

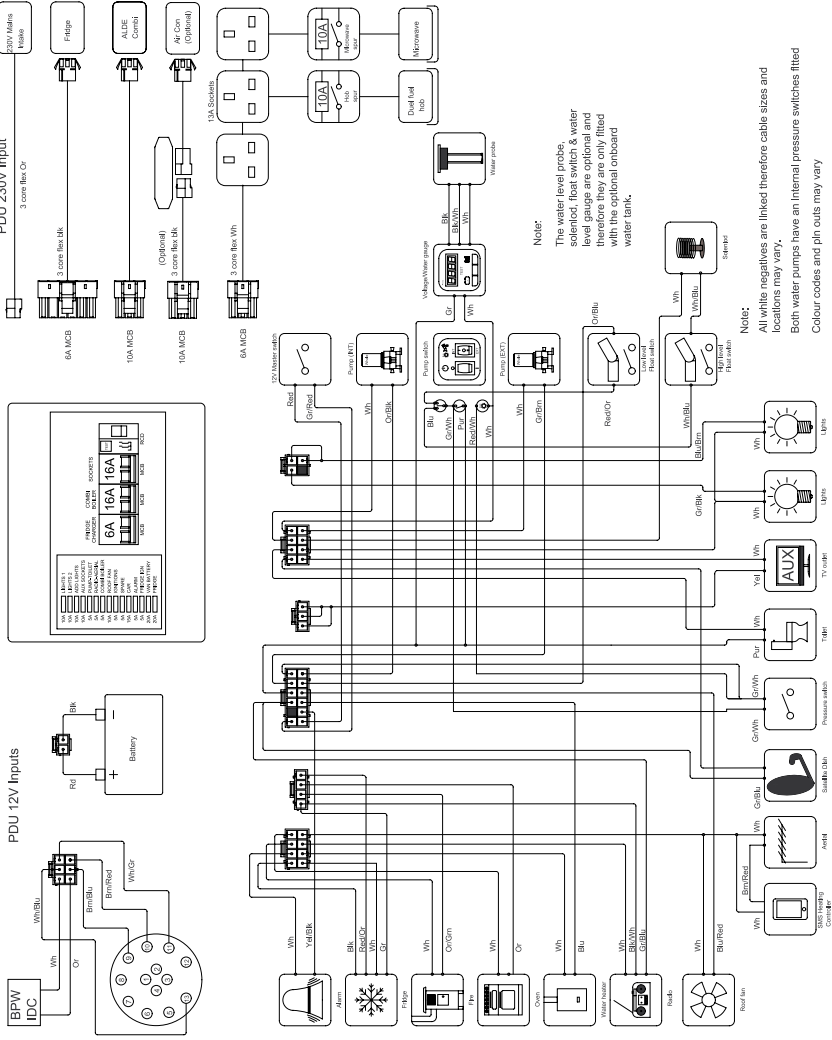

Colour Key

- Wh - White
- Yel - Yellow
- Or - Orange
- Red - Red
- Gr - Green
- Blu - Blue
- Pur - Purple
- BK - Black
- Brn/Blu - Brown/Blue
- Brn/Red - Brown/Red
- Wh/Gr - White/Green
- Wh/Blu - White/Blue
- Yel/BK - Yellow/Black
- Red/Or - Red/Orange
- Or/Gr - Orange/Green
- BK/Wh - Black/White
- Gr/Blu - Green/Blue
- Blu/Red - Blue/Red
- Blu/Brn - Blue/Brown
- Gr/Bk - Green/Black
- Wh/Blu - White/Blue
- Gr/Red - Green/Red
- Or/Bk - Orange/Black
- Gr/Brn - Green/Brown
- Red/Wh - Red/White

Note:
The water level probe, solenoid, float switch & water level gauge are optional and therefore they are only fitted with the optional onboard water tank.

Note:
All white negatives are linked therefore cable sizes and locations may vary.
Both water pumps have an internal pressure switches fitted
Colour codes and pin outs may vary



ROAD LIGHTS - CAMINO

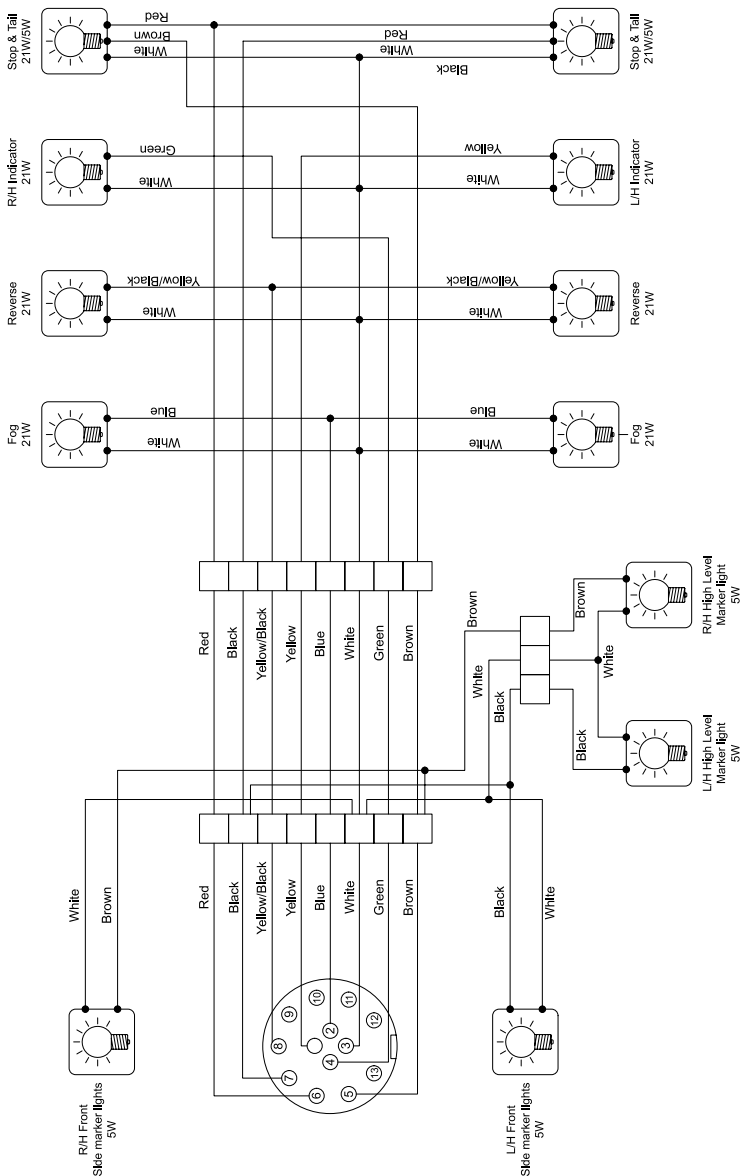



GENERAL QUESTIONS

Q: What is SoLiD construction?

A: SoLiD construction is unique and our jointing system, coupled with Henkel's tried and tested structural bonding adhesives, spreads the stresses and strains evenly across all joints and creates an impervious barrier to water ingress.

Q: Where Can I Obtain Your Latest Brochure?

A: Our latest brochures are available from Approved Retailers or can be viewed and printed from our website www.elddis.co.uk. A request form can also be completed should you wish to receive a printed copy of our latest brochures.

Q: Why Is the Handbook Not Specific To My Model?

A: Many of the components used in the manufacture of our caravans are identical throughout our model ranges, so we produce a generic handbook, which covers all models manufactured within a range for that season. If the literature supplied with your caravan does not answer your question then please contact your Retailer for further assistance.

Q. I Require Technical Or Other Information, Who Can Help Me?

A. The majority of information you require is available through your Elddis Retailer or Service Centre.

Q - Can You Tell Me The Second Hand Price Of My Caravan?

A - As a manufacturer we are not involved in the second hand market. You should contact a Retailer, The Camping and Caravanning Club and/or The Caravan Club. They should be able to give some indication of market value.

Q: How Can I Avoid Excessive Caravan Snaking When I Tow And What Should I Do If It Starts?

A: Elddis has extensively tested our caravans and we are confident of their stability. However, many other factors can influence your towing unit. When loading your caravan put heavy items low down and mainly over the axle(s). You should not stow tins, bottles or heavy items in overhead lockers, during towing. Everything else should be distributed evenly around your caravan, front and back, and each side of the centre line. Should snaking start, if at all possible don't brake and don't compensate by steering into the swings. Just ease up on the accelerator and allow your speed to gradually decrease until the snaking subsides.

Q: What Is The Correct Awning Size For My Caravan?

A: Ground to ground awning measurements for Elddis caravans can be found by looking in the latest model section, the Brochure Archive section on our website, or by referring to the relevant Technical Data Sheet, however, we advise you verify this information by threading a piece of string through the awning channel from ground to ground, and then by measuring the string. Your awning manufacturer will then advise on the nearest size of awning appropriate for your measurement.

Q: Can I Fit A Bicycle Rack?

A: Yes contact your Elddis Retailer for details of our recommended bike rack.

Q: Can I Fit A Top-Box?

A: No.

Q: Can I Fit An Air Con?

A: Please refer to Website.

**Q: My Interior Lights Are Not Working, What Do I Do?**

A: It is possible that all of the 12V mains electrical equipment may not be operated simultaneously. Check fuses, battery connections and power supply (master light switch). Refer to your Retailer or Service Centre for further assistance. PLEASE NOTE: The internal lights in your caravan will not operate whilst the caravan's electrical hitch cables are connected to a towing vehicle with the engine running.

Q: Where Can I Get Spare Parts For My Caravan?

A: Retailers/Service Centres will be able to source most parts you require. For details of your nearest Elddis Retailer please refer to our Find A Retailer section on our website.

Q. How Many Years Will Spare Parts Be Available For My Caravan?

A. Elddis will endeavour to supply spare parts for a caravan, for up to 8 years from date of manufacture.

Q. What If The Parts Are No Longer Available?

A. Where an original part is no longer available, whenever possible we will suggest a suitable alternative if it is available.

Q. Who Can Carry Out Warranty Work On My Caravan?

A: Your supplying Retailer is obliged to undertake your warranty work. However, any Elddis approved Retailer / Service Centre can undertake the work, but this is at their discretion. We will also accept services completed by a NCC approved service centre, or NCC equivalent standard as set out in this handbook but they will not be able to undertake warranty work if they are not approved by Elddis.

Q. Why Don't You Stock Parts At The Elddis Factory?

A. Due to the volume of models we produce it is not possible for us to maintain stock levels of every individual component used in our manufacturing process. We do stock commonly requested items, but some items must be made to order.

Q. I Am Having Trouble Booking My Caravan For Its Service, In Line With The Requirements. What Timescale Is Acceptable?

A. Please refer to the warranty section for the terms and conditions of servicing. We would recommend that you plan your services in advance in order to meet the requirements.

Q. I Have A Problem With My Caravan, Who Can Help Me?

A. We would always recommend that you contact your supplying Retailer. Your local Elddis Retailer or Elddis Approved Service Centre may be able to assist. An inspection can then take place and the necessary course of action agreed.

Q. I Am Unhappy With The Service I Have Received From My Retailer/Service Centre, Where Do I Go From Here?

A. We would recommend that you write to your Retailer/Service Centre, detailing your problems and requirements, requesting a response explaining how they will resolve your complaint. A copy of your letter can also be forwarded to The Elddis Customer Care Department, quoting the serial number of your caravan and the name of the Retailer/Service Centre. Please be assured that we will assist your Retailer/Service Centre in resolving any problems.

GLOSSARY

13 pin plug

The plug used to connect the caravans electrical system to your towing vehicle to enable the road lights, refrigerator and battery charger to operate during towing.

A Frame

This is the triangular part at the front of the caravan's chassis which is between the main body and the hitch it is also called the drawbar.

Actual Laden Weight

This is the total weight of the caravan when loaded ready for use by the end user.

Aquaroll

Brand name used generically for a water container that rolls so you don't need to lift it.

Awning

This is a tent-like structure of fabric over a supporting framework, which can be attached to the side of caravan.

Battery Charger

This is required to keep a leisure battery charged. All caravans include a charging facility which operates via the mains hook-up, and also has the ability to recharge from the tow car's alternator while travelling.

Berth(s)

Sleeping place - Refers to the number of people a caravan can accommodate for sleeping.

Blown Air Heating

A method of heating the living quarters of a caravan by use of a fan pushing air out through a number of outlets.

Breakaway Cable

A thin steel cable linking the caravan handbrake to the vehicles tow bar - In the event of the caravan becoming detached from the car, the cable will pull the caravan handbrake on before snapping.

Bunk Bed

This is a sleeping place, usually higher up than a conventional bed. Often (but not always) this can be folded or removed to provide additional living space.

Butane

Is a form of Liquefied Petroleum Gas (LPG) which normally comes in blue cylinders. This type of gas is most commonly used in the UK, although a switch to propane is advised in severely cold weather conditions.

Calor

This is the main supplier of propane (red) gas cylinders and significant seller of butane (blue) gas.

Campingaz

This is the trade name of Butane gas.

Cassette Blind

This is a roller blind which is fitted as part of the window assembly, often along with a flyscreen, thus giving a neat installation.

Cassette Toilet

A form of chemical toilet found in modern caravans, where the waste holding tank can be accessed and emptied from, outside.

Chemical Toilet

A toilet that has a compartment in which waste is treated with chemicals.

Control Panel

Used as the description for the panel of electrical switches and gauges governing 12V and mains electricity systems.

Corner Steadies

The winding device built into each corner of a caravan chassis that is used to stabilise the body once set up on a pitch.

Coupling Head - See hitch.

CRiS

This is the Caravan Registration and Identification Scheme. It is a voluntary scheme which registers caravans in a similar manner to how motor vehicles are registered. Allows you to check the legitimate right to ownership of the seller of a secondhand caravan, and helps in the recovery of stolen caravans.

Dinette

This is a popular style of seating arrangement where two seats or settees face each other across a table.

**Earth Leakage Circuit Breaker**

ELCB Earth leakage circuit breaker - see residual current device (RCD)

Essential Habitation Equipment

Those items and fluids required for the safe and proper functioning of the equipment for habitation as defined by the manufacturer of the caravan.

Flyscreens

Mesh fittings for windows doors and roof vents, to keep out insects etc.

Free-Standing Table

This is a table which, because of its leg design, can be used inside or outside.

Full Service Pitch

This is a pitch which has individual provision for fresh water supply and waste water disposal, in addition to mains electricity and in some cases TV aerial connection.

Gas Cylinder

This is a portable, pressurised container for the storage of LPG.

Gas Cylinder Locker

Is the compartment on the caravan for the storage of gas cylinders.

Gas Drop out Holes

These are not part of the ventilation. LPG is heavier than air, so holes through the floor below gas-powered appliances allow any leakage of gas to exit the habitation area.

Grey Water

This is the waste water from sink/shower.

Gross Train Weight

This is also known as Combined Weight. The maximum permitted weight of an outfit as specified by the tow car manufacturer.

Gross Vehicle Weight (GVW)

This is the weight of the vehicle laden to its maximum, as defined by the manufacturer. See also MTPLM.

GRP

Is Glass-reinforced plastic, but more commonly known as glass fibre (not fibre glass, which is a trade name).

Handbook

This is a generic owners manual, a guide to the workings of your caravan.

Hardstanding

This is a pitch which has a hard surface made of gravel, asphalt, concrete etc, instead of grass.

Hitch

This is the mechanism which allows a caravan to be attached to a tow ball.

Hitch Lock

A security device that prevents the caravan hitch being used.

Hook-Up

This is a facility on a pitch for connection to mains electricity.

Ingress

The entry of water into the caravan structure.

Jack

This is a device for raising the vehicle so that a wheel can be changed, for instance. Not to be confused with corner steadies which although they are sometimes referred to as 'corner jacks' are steadying, not lifting devices.

Jockey Wheel

The small front wheel attached to the caravan A-frame used to support the forward end of the caravan, when detached from the towing vehicle.

Kerb Weight

This is the empty weight of a motor vehicle as defined by the manufacturer.

Layout

This is the interior design and details where furniture units are placed in relation to each other.

Leisure Battery

This supplies the power for the caravans 12V electrical systems and is sometimes called an auxiliary battery.

Levelling

The process of ensuring that a caravan is level when sited on a pitch. It is important for comfort and also to ensure the correct functioning of the fridge and water systems.

LPG

Liquid Petroleum Gas, i.e. butane or propane.

L-Shaped

This is a term where the seating area of a caravan is indeed L-shaped.

Mains Hook-Up

This is a campsite facility where you can plug into a mains electricity supply.

Maximum Hitch Height

The maximum height at which the hitch should be connected to a towing vehicle

Maximum Permissible Towing Weight

This is the maximum weight that the towing vehicle is allowed to tow.

Maximum User Payload

This is the maximum payload available for the user.

MIRO - Mass In Running Order

Weight of the caravan equipped to the manufacturer's standard specification including essential habitational equipment.

MTPLM - Maximum Technically Permissible Laden Mass

The technical maximum permissible laden weight of the caravan, this must not be exceeded.

NCC (National Caravan Council)

The only trade association representing manufacturers, retailers and suppliers within the caravan industry.

Nose weight

The weight exerted on the tow bar. Special scales are available from accessory shops for measuring this weight.

Number Plate

Caravans must display a legal number plate showing the same registration mark as their towing vehicle.

Optional Equipment Payload

The payload required for equipment to enable the caravan to be used for habitation purposes.

Outfit

The caravan and its towing vehicle considered as a unit.

Owners' Club

This is a group of people who usually own the same brand of caravan and enjoy meeting up for rallies.

Payload

The amount you can put into a caravan. Specifically the difference between the Maximum Technical Permissible Laden Mass (MTPLM) and the Mass In Running Order (MIRO).

PDI

This is an inspection undertaken by the Retailer prior to handover to the customer.

Pitch

A designated area of a caravan site allocated for the use of one outfit. Most sites will be arranged with defined pitches.

Propane

Gas used in colder conditions and is usually supplied in red cylinders.

RCD

This is a residual current device and is part of the electrical system which will 'trip' if there is an electrical fault.

Gas Regulator

Safety device fitted between the gas cylinder and the gas system of a caravan, which controls the pressure of gas being released from the cylinder.

**Road Lights**

The external lights used while the vehicle is travelling.

Roof Lights - See Roof Vent.

Roof Vent

Is an opening unit in the ceiling which lets in ventilation and light, these vary in size, but the best ones will have integral blinds and flyscreens and are also called rooflights.

Semi-Rigid Pipe work

Is water pipes made of a semi rigid plastic and are infinitely preferable to cheaper convoluted piping which can act as a trap for germs and smells.

Single Axle

This is a caravan with a single pair of wheels on one axle. See also twin axle.

Slats

Sometimes used for beds and can improve ventilation to mattress cushions.

Space Heater

This is a type of heating equipment for the living quarters. Modern units fitted offer gas and mains-operation.

Speed Rating

This is the maximum speed at which a tyre may be used, as marked on its sidewall.

Stabiliser

A safety device which helps to prevent instability, this is done by increasing the friction between the caravan hitch and the tow ball.

Steady Winder

A handle for operating the corner steadies.

Torque Wrench

A form of spanner used to set nuts and bolts to a specified degree of tightness. It is recommended for adjustment of wheel fixings on caravans.

Towing Limit

See manufacturer's braked towing limit and manufacturer's unbraked towing limit.

Towing Mirrors

Additional rear vision mirrors added to a towing vehicle to provide a greater width of view to see past a caravan.

Train Weight

The maximum permissible combined weight of tow car and touring caravan.

Twin Axle

Is a caravan with two pairs of wheels, on two axles which are located close together.

These are usually the larger, heavier caravans, where the second axle helps carry the greater weight more easily, and also makes a longer caravan more stable to tow. See also single axle.

User Payload

The weight of all items carried in the caravan.

U-Shaped Settee

Usually a reference to seating that literally is 'U' shaped.

Vehicle Kerb weight

The weight of the tow car often indicated in the manufacturers specifications..

VIN - Vehicle Identification Number

This is a unique serial identification number for a vehicle. All Cars and motor caravans should carry a VIN. Caravans are not obliged to, but most of those sold in recent years in the UK do as a result of the CRiS voluntary registration scheme.

Warranty

Is the terms and conditions that spell out your rights with regard to servicing, repair or replacement of parts as provided by the manufacturer.

Wild Camping

Term used for staying overnight away from a campsite. Illegal in many countries, but permission may be granted by individual landowners.



SERVICE DOCUMENTS

TOURING CARAVANS - ANNUAL SERVICE RECORD

In order to ensure your warranty remains valid an annual service must be carried out in accordance with the requirements of this handbook. You are responsible for any charges incurred for the service of your vehicle. If the annual service is performed by an authorised Approved Retailer / Service Centre or NCC Approved Workshop then Erwin Hymer Group UK Limited deems that the service has been performed correctly.

You may choose to have your annual service performed by an unauthorised repairer / service centre and if you do it will be your responsibility to ensure that the service meets our requirements.

We will ask you to provide a copy of the following documentation:

- Damp report
- Annual Habitation Service check list (to the minimum standard set out in this handbook)
- Invoice / dated service stamp
- Gas and Electrical certificates for the vehicle

If the Annual Service has not been performed in accordance with the requirements in this handbook your warranty will be invalidated, however this will not affect your legal or statutory rights as a customer.

Eddis will not pay any unapproved Service Centre for the undertaking of any warranty work.

Minimum service requirements

The service must be undertaken by suitably qualified personnel.

A full damp test check should be undertaken and damp readings recorded.

A service check must be performed to the minimum standards set out below.

Annual Habitation Service check list

UNDERBODY

Item	Condition
Corner steadies, folding step and spare wheel carrier where applicable - check operation and lubricate	
Under slung tanks and pipes - check condition and security	
Body Attachment - check security of body to the chassis	

UNDERBODY (Caravans Only)

Item	Condition
Coupling head / Ball acting stabiliser - check wear or damage & lubricate	
Nose weight - check & report (best practice)	
Coupling head gaiter - check for splits	
Breakaway cable & clip - check condition, routing & integrity	
Drawbar - check	
Jockey wheel - check condition and lubricate	
Check chassis condition	
Wheels and tyres - check for damage, wear, depths and pressures (incl. spare)	



UNDERBODY (Caravans Only) (continued)

Item	Condition
Remove brake drums - clean & check hub bearings & seals	
Clean brake shoes & check condition (incl. springs and expanders)	
Brake rods, cables & supports-check operation, lubricate and adjust	
Refit brake drums – fit new hub nuts and torque to manufacturers settings, adjust brakes & check operation	
Replace road wheels & torque to manufacturers settings	
Handbrake mechanism - check operation, adjust & lubricate	
Check self-levelling to manufacturers requirements (where applicable)	

ELECTRICAL SYSTEMS

Item	Condition
Check the leisure battery is being charged from both the engine when running, or with a multi-tester (caravans) and the mains charger	
Leisure Battery (if fitted) - check condition of the battery & its compartment	
Leisure Battery (if fitted) - check condition, top up fluid if required and check the charge condition	
Interior lighting & equipment - check operation and fuse rating	
Awning light - check operation	
Wiring earths - check for defects on all ELV circuits (Visual)	
LV inlet plug & extension lead – check condition & resistance across pins	
Earth Bonding - visual inspection	
RCD unit - check operation of RCD test button and operations of MCBs	
230V appliances - check operation	
Air conditioning (if fitted) - check operation	
13 pin plug - check condition	
230V sockets - check for correct polarity	

GAS SYSTEMS

Item	Condition
Regulator and gas hose - check age performance and security	
Perform a gas pressure check	
LPG Tank (if fitted) - check security	
Flame failure devices - check operation	
Gas cylinder - check security	
Gas dispersal holes - check they are clear from obstructions.	

APPLIANCES (check gas and electric operation)

Item	Condition
Fridge - check operation from 12V, 230V & gas	
Hob - check operation	
Oven - check operation	
Grill and fan - check operation	
Water boiler – Check operation	
Heater - check operation and top up header tank with anti-freeze (where applicable), bleed as necessary	
Any additional permanently fitted appliances	

WATER SYSTEM

Item	Condition
Water pump & pressure switch - check operation	
Taps, pipes and micro switches - check operation	
Water filter housing & inline filter - check for leaks & replace filter where necessary	
Water system - check for leaks	
Water Tanks (if fitted) - check security of all water tanks including underslung tanks.	
Toilet - check security, operation of flush pump and free from obstructions.	
Drain down the system when checks are complete.	

VENTILATION

Item	Condition
Rooflights - check all are free from obstructions, cracks and have a free air flow	
Floor vents - remove protective cover and check they are clear from obstruction then refit covers	

FIRE & SAFETY

Item	Condition
Smoke and carbon dioxide detectors - check for operation via the test buttons fitted, check battery condition.	
Fire Extinguisher (if fitted) - check it is still within date	
Fire Blanket (if fitted) - check it is still within date	
Habitation door operation	
Motormover - check 12v cables are sealed at entry to battery box (where fitted)	



BODYWORK

Item	Condition
Doors and windows - check all catches are present and operating correctly.	
Blinds and flyscreens - check condition and operation	
Roof - check condition of roof.	
Cab seats - check condition of the seats and seats belts	
Floor - check condition of floor	
Furniture - check condition of the furniture	
Damp Test - undertake a damp test and record all readings taken.	
Lubricate all locks	

CARE WARRANTY

It is a condition of this warranty that a service and safety check is carried out by your caravan retailer at least once a year (12 months from the date of purchase) in accordance with the NCC recommendations.

ANNUAL SERVICE RECORD

MODEL

VEHICLE IDENTIFICATION NUMBER YEAR

1st SERVICE

DATE:

RETAILERS STAMP:

I/We certify that an annual service has been carried out in accordance with the manufacturers' and NCC recommendations.

2nd SERVICE

DATE:

RETAILERS STAMP:

I/We certify that an annual service has been carried out in accordance with the manufacturers' and NCC recommendations.

3rd SERVICE

DATE:

RETAILERS STAMP:

I/We certify that an annual service has been carried out in accordance with the manufacturers' and NCC recommendations.

4th SERVICE

DATE:

RETAILERS STAMP:

I/We certify that an annual service has been carried out in accordance with the manufacturers' and NCC recommendations.



5th SERVICE

DATE:

RETAILERS STAMP:

I/We certify that an annual service has been carried out in accordance with the manufacturers' and NCC recommendations.

6th SERVICE

DATE:

RETAILERS STAMP:

I/We certify that an annual service has been carried out in accordance with the manufacturers' and NCC recommendations.

7th SERVICE

DATE:

RETAILERS STAMP:

I/We certify that an annual service has been carried out in accordance with the manufacturers' and NCC recommendations.

8th SERVICE

DATE:

RETAILERS STAMP:

I/We certify that an annual service has been carried out in accordance with the manufacturers' and NCC recommendations.

9th SERVICE

DATE:

RETAILERS STAMP:

I/We certify that an annual service has been carried out in accordance with the manufacturers' and NCC recommendations.

10th SERVICE

DATE:

RETAILERS STAMP:

I/We certify that an annual service has been carried out in accordance with the manufacturers' and NCC recommendations.

11th SERVICE

DATE:

RETAILERS STAMP:

I/We certify that an annual service has been carried out in accordance with the manufacturers' and NCC recommendations.

12th SERVICE

DATE:

RETAILERS STAMP:

I/We certify that an annual service has been carried out in accordance with the manufacturers' and NCC recommendations.



13th SERVICE

DATE:

RETAILERS STAMP:

I/We certify that an annual service has been carried out in accordance with the manufacturers' and NCC recommendations.

14th SERVICE

DATE:

RETAILERS STAMP:

I/We certify that an annual service has been carried out in accordance with the manufacturers' and NCC recommendations.

15th SERVICE

DATE:

RETAILERS STAMP:

I/We certify that an annual service has been carried out in accordance with the manufacturers' and NCC recommendations.

16th SERVICE

DATE:

RETAILERS STAMP:

I/We certify that an annual service has been carried out in accordance with the manufacturers' and NCC recommendations.

17th SERVICE

DATE:

RETAILERS STAMP:

I/We certify that an annual service has been carried out in accordance with the manufacturers' and NCC recommendations.

18th SERVICE

DATE:

RETAILERS STAMP:

I/We certify that an annual service has been carried out in accordance with the manufacturers' and NCC recommendations.

19th SERVICE

DATE:

RETAILERS STAMP:

I/We certify that an annual service has been carried out in accordance with the manufacturers' and NCC recommendations.

20th SERVICE

DATE:

RETAILERS STAMP:

I/We certify that an annual service has been carried out in accordance with the manufacturers' and NCC recommendations.



NOTIFICATION OF CHANGE OF OWNERSHIP

If you purchase this vehicle as a used vehicle it may be possible to transfer the unexpired term of the warranty cover (up to a maximum of six years commencing at the original date of purchase from new). Please refer to the warranty section of the handbook for terms and conditions.

Please complete the attached form and post it to us along with the following information:

- A copy of the new CRIS registration form
- A copy of the service handbook displaying complete and up to date service history including service checklist and damp report.
- A cheque for £50 made payable to Erwin Hymer Group UK Limited.

Transfer of ownership must be made within the first three months of any change of legal ownership in order for the warranty cover to remain valid.

Erwin Hymer Group UK Limited Customer Care

Delves lane

Consett

County Durham

DH8 7PE

www.elddis.co.uk

Email documents to customer.care@erwinhymergroup.co.uk payment can then be taken over the phone.

This form is also available for you to print from our web site.

NOTIFICATION OF CHANGE OF OWNERSHIP

Previous owner details (if known):

Name:

Address:

.....

..... Post code:

Email:

New owner details:

Name:

Address:

.....

..... Post code:

Daytime telephone number: Date of purchase:

Email:

Details of Caravan:

Range: Model:

Vehicle identification number (17 digits):

* In order for you warranty to remain valid, your caravan must have been serviced annually by an Approved Retailer / Service Centre, NCC Approved Workshop or NCC equivalent standard as set out in this handbook.

If you do not want to receive information about products and services from Elddis, please tick.



NOTIFICATION OF CHANGE TO NAME AND ADDRESS

In order that we can provide you with the very best level of service we ask that you keep us informed of any changes to your contact details.

Should your details change please complete the online form on our website, in our 'Help & Support' section, sub section 'Warranty'. Alternatively, please complete the attached form and post to us:

Erwin Hymer Group UK Limited Customer Care
Delves Lane
Consett
County Durham
DH8 7PE
www.elddis.co.uk

.....

NOTIFICATION OF CHANGE TO NAME AND ADDRESS

Previous details:

Name:

Address:

.....

..... Post code:

Email:

New details:

Name:

Address:

.....

..... Post code:

Daytime telephone number: Date of purchase:

Email:

Details of your Caravan:

Range: Model:

Vehicle identification number (17 digits):

If you do not want to receive information about products and services from Eddis or Buccaneer, please tick.



Compass



USEFUL ADDRESSES

AL-KO (Chassis Supplier)

South Warwickshire Business Park
Kineton Road, Southam
Warwickshire, CV47 0AL
Fax: 01926 818562
email: mail@al-ko.co.uk

Theftord Ltd

(Hobs, Grill, Oven and Toilet supplier)
Unit 19, Oakham Drive
Parkwood Industrial Estate
Rutland Road, Sheffield, S3 9QX
Tel: 0114 273 8157
Fax: 0114 5753094
email: infogb@thetford.eu

Alde International (UK) Ltd

(Wet central heating supplier)
Huxley Close, Park Farm South
Wellingborough, Northants, NN8 6AB
Tel: 01933 677765
Fax: 01933 674975
email: info@alde.co.uk

Dometic (UK) Ltd

(Fridge Supplier)
Dometic House, The Brewery
Blandford St Mary, Dorset, DT11 9LS
Tel: 0844 626 0133
email: technical@dometic.co.uk

Whale Ltd

Munster Simms Engineering Ltd
2 & 2A Enterprise Road, Bangor
BT19 7TA
Northern Ireland
Tel: 02891 270531

**A**

- Alarm
 - Autowatch Alarm System 8-49
- Alko Chassis 13-1
- ATC (Automatic Trailer Control) 8-50

B

- Battery Installation 7-1
- Battery Maintenance 7-1
- Blinds 8-38

C

- Caravan Chassis
 - Operating instructions... 3-2, 10-8
- Caravan Construction -
 - Main Components 13-1
 - Awning Channel 13-1
 - Braking System 13-1
 - Front Panel and Gas Bottle
 - Locker Door 13-1
 - Solid Construction
 - Body Shell 13-1
 - Windows 13-1
- Caravan Handling 4-1
- Care of your Caravan 10-1
 - ABS Panels & Fittings 10-2
 - Acrylic Windows 10-1
 - Carpets, Upholstery and
 - Curtains 10-2
 - Chassis Mounted Spare
 - Wheel Carrier 10-5
 - Cleaning of all Taps 10-3
 - Cooking Equipment 10-2
 - Exterior Cleaning 10-1
 - Furniture 10-2
 - Glass Fibre Reinforced
 - Plastic (GRP) 10-1
 - Interior Walls 10-2
 - Jacking 10-6
 - Lubrication 10-6

- Shower Trays, Shower Room
 - and Wash Basin Fittings ... 10-3
- Thetford Toilet 10-4
- Tyres 10-5
- Water Containers 10-4
- Water Systems - Sterilisation 10-4

- Care of your caravan
 - Changing a Wheel 10-5
- Charging System 7-2
- Code of Practice
 - Remedial Work 12-4

E

- Electrical Control Panels 8-1
- Electrical System 7-1
- Electricity 6-1
 - 12v Systems 6-1
 - Connecting To Mains Supply .. 6-1
 - Disconnecting Mains Supply .. 6-2
 - Generator/Charger 6-1
 - Mains Supply 6-1
 - Overseas Electrical
 - Connection 6-2
 - Power Supply Charger 6-1
- Entertainment System 8-45

F

- Fire Safety 2-2

G

- Gas 6-4
 - Connection 6-4
 - Hoses 6-6
- Gas Safety Advice 6-3
- Generators / Charger 7-1
- Glossary 16-1

H

- Heating System
 - Alde 8-11



I		Additional Security	9-4
Insulation	13-1	Caravan Theft	9-1
Introduction	1-1	CRIS	9-1
L		Electronic Tagging	9-4
LED lighting	7-2	Service Documents	17-1
Leveller Jack	5-1	Setting Off	4-1
Levelling, front & back	5-1	Site Regulations	5-1
Levelling, side to side	5-1	Speed Limits	4-1
M		Storage	
Mains Unit	7-2	Long Term & Winter	11-1
Model Year	1-2	T	
N		Taps	8-39
Notification of Change of		Toilet	
Ownership	18-1	Thetford C260	8-29
Notification of Change to		Towing Weight Ratio	3-1
name and address	19-1	Tracker	9-1
P		Tyres	10-5
Parking	5-2	V	
Pitch, selecting	5-1	Ventilation	2-2
Power Drain	11-1	W	
Pre-Tow Checklist	3-2	Wheel Changing	10-5
R		Wheel Lock	9-2
Radio/CD with MP3	8-44	Windows	8-38
Ramp	5-1	Wiring Diagrams	14-1
RCD	7-2		
Refrigerator (RM8551)	8-8		
Reversing	4-1		
Road Lights	14-2		
Rooflights	8-35		
S			
Safety, general	2-1		
Seating (wrap round)	8-44		
Security			



Compass

INDEX





Erwin Hymer Group UK Limited Delves Lane, Consett, Co. Durham DH8 7PE
Telephone: 0371 964 2113 • www.elddis.co.uk

All the illustrations and descriptive matter in this guide are intended to give a general idea of the caravan. Changing market and supply situations may prevent the manufacturer from maintaining the exact specifications and details in this handbook and we therefore reserve the right to alter specifications and materials as conditions demand.

Retailers are independent of the manufacturer and have absolutely no authority to bind the manufacturer by any express or implied undertaking or representation.

Model Year 2021