



<b>WELCOME &amp; INTRODUCTION</b> .....	<b>1-1</b>	Road Safe Gas Regulator .....	6-4
End Of Life Vehicle Directive .....	1-1	High Pressure Gas Hoses .....	6-5
Elddis Technical Approvals .....	1-2	Water System .....	6-5
<b>GENERAL SAFETY</b> .....	<b>2-1</b>	Filling your Fresh Water Tank .....	6-5
Please read before using your new Motorhome. ....	2-1	Waste Water Tank .....	6-5
Proper And Safe Use Of Storage Areas In Motorhomes .....	2-1	Draining Down Your Water System .....	6-5
Ventilation .....	2-2	<b>GAS SAFETY ADVICE</b> .....	<b>7-1</b>
High-Level Ventilation .....	2-2	Facts about LPG .....	7-1
Low-Level Ventilation .....	2-2	Awning Spaces, LPG and Appliance Exhaust .....	7-1
Ventilation in Separate Bedrooms .....	2-2	LPG Gas System .....	7-1
Gas Dispersal Holes .....	2-2	<b>ELECTRICAL SYSTEM</b> .....	<b>8-1</b>
Fire Safety .....	2-2	12v Power Supply .....	8-1
Fire Extinguishers .....	2-2	Battery Installation .....	8-1
In Case Of Fire .....	2-2	Battery Maintenance .....	8-1
Fire Retardant Foams .....	2-2	Generators / Charger .....	8-1
Habitation Door .....	2-2	230v Power Supply .....	8-1
<b>PREPARING FOR THE ROAD</b> .....	<b>3-1</b>	Mains Unit .....	8-1
Motorhome Weights Explained .....	3-1	Resetting the RCD .....	8-2
Mass in Running Order .....	3-1	Automatic Charging System .....	8-2
Maximum Technically Permissible Laden Mass .....	3-1	Schautt WA 121525 Booster Unit .....	8-2
User Payload .....	3-1	General .....	8-2
Loading .....	3-1	Function .....	8-2
Before Moving Off .....	3-1	Location .....	8-3
Pulling Off .....	3-2	Internal Lights .....	8-3
Bicycle Racks .....	3-2	Maximum Bulb Ratings for Internal Lights	8-3
Tow Bars .....	3-2	<b>HOW TO USE YOUR MOTORHOMES</b>	
<b>MOTORWAY HANDLING</b> .....	<b>4-1</b>	<b>EQUIPMENT</b> .....	<b>9-1</b>
Best Practice .....	4-1	How To Operate Your Motorhome	
Speed Limits .....	4-1	Entrance Door .....	9-1
Towing Your Motorhome .....	4-1	Control Panel .....	9-2
<b>ARRIVING ON SITE</b> .....	<b>5-1</b>	Circular Function Buttons .....	9-2
Check Site Regulations .....	5-1	Oven, Hob and Grill .....	9-5
Selecting A Pitch .....	5-1	Safety .....	9-5
Lateral Levelling (Side To Side) .....	5-1	Use of the Burners .....	9-7
Leveller Jack .....	5-1	Use of the Electric Hotplate (if applicable)	9-7
Ramp .....	5-1	Use of the Grill .....	9-8
<b>GETTING STARTED</b> .....	<b>6-1</b>	Use of the Oven .....	9-8
Electricity .....	6-1	Safe Cooking .....	9-9
Power Supply Charger .....	6-1	Temperature Control .....	9-9
12v Systems: .....	6-1	Maintenance and Cleaning .....	9-10
Generator/Charger .....	6-1	Refrigerator .....	9-11
Electricity Mains Supply .....	6-1	Operation .....	9-11
Connecting To Mains Supply On Arrival at Site .....	6-1	RML10.4S (where fitted) .....	9-14
Disconnecting Mains Supply When Leaving Site .....	6-2	Safety when Operating .....	9-14
Overseas Electrical Connection .....	6-2	Using the Refrigerator .....	9-15
Gas Supply .....	6-3	Tips for Optimal Refrigerator Operation	9-15
Connection .....	6-3	Operating and Display Elements .....	9-15
Gas Regulator .....	6-3	Operating the Refrigerator .....	9-15
		Tank Stop Mode .....	9-15
		Setting the Cooling Capacity .....	9-15
		Troubleshooting .....	9-16
		Fault messages and Signal Tones .....	9-17



Alde Heating (3020 Control Panel) .....	9-21	<b>SECURITY .....</b>	<b>10-1</b>
Turning the Boiler On and Off .....	9-21	Tracker (Option) .....	10-1
Standby .....	9-21	Motorhome Theft .....	10-1
Settings Menu .....	9-22	VIN Chip .....	10-1
Set the Desired Temperature .....	9-22	<b>CARE OF YOUR MOTORHOME .....</b>	<b>11-1</b>
Domestic Hot Water .....	9-22	Exterior Body Shell .....	11-1
Heating with Electricity .....	9-23	Glass Fibre Reinforced Plastic (GRP) ...	11-1
Heating with Gas .....	9-24	Acrylic Windows .....	11-1
*Fully Automatic Climate Control (ACC)	9-24	Window Blinds & Flyscreens .....	11-1
Activated Functions A .....	9-25	ABS - Wheel Spats & Panels .....	11-1
Tools Menu .....	9-26	Interior Walls .....	11-1
Tools Menu - Functions .....	9-26	Carpets, Upholstery And Curtains .....	11-2
Service Menu .....	9-30	Washroom And Handbasin Fittings .....	11-2
Fluid level of Heating System .....	9-31	Shower Trays .....	11-2
Microwave .....	9-34	Water Systems .....	11-2
Battery Charger .....	9-34	Water Containers .....	11-2
Smoke Alarm .....	9-35	Internal Water Systems .....	11-2
Carbon Monoxide Alarm .....	9-37	Thetford Toilet .....	11-3
Rooflights .....	9-41	Changing A Wheel .....	11-3
The Heki 2 .....	9-41	<b>STORAGE .....</b>	<b>12-1</b>
To Open To The Tilted Position: .....	9-41	Long Term & Winter Storage .....	12-1
To Open In The Intermediate Position: ..	9-41	Motorhome Covers .....	12-1
To Open In The Ventilation Position: ..	9-41	Battery Maintenance .....	12-1
Closing The Blinds: .....	9-41	<b>MOTORHOME HABITATION</b>	
Opening The Blinds: .....	9-41	<b>WARRANTY COVER .....</b>	<b>13-1</b>
The Omnivent (12v) Rooflight .....	9-42	Non Warranty Repairs .....	13-3
Door Flyscreen .....	9-42	Remedial Work .....	13-3
Taps .....	9-42	<b>MOTORHOME CONSTRUCTION -</b>	
Kitchen Taps .....	9-42	<b>MAIN COMPONENTS .....</b>	<b>14-1</b>
Internal Doors .....	9-43	Solid Construction Body Shell .....	14-1
Toilet / Washroom Doors .....	9-43	Windows .....	14-1
Other Internal Doors .....	9-43	Insulation .....	14-1
Magnetic Catches .....	9-43	<b>ELECTRICAL DRAWINGS .....</b>	<b>15-1</b>
Locker Door Catches (Paddle Latch) ...	9-43	<b>GENERAL QUESTIONS .....</b>	<b>16-1</b>
Concealed Latch .....	9-43	<b>GLOSSARY .....</b>	<b>17-1</b>
Thetford Cassette C260 Toilet .....	9-44	<b>ANNUAL HABITATION</b>	
Parts .....	9-44	<b>SERVICE RECORDS .....</b>	<b>18-1</b>
Optional Features .....	9-44	<b>NOTIFICATION OF CHANGE OF</b>	
Preparing for Use (Standard) .....	9-44	<b>OWNERSHIP .....</b>	<b>19-1</b>
Using the Toilet (Standard) .....	9-46	<b>NOTIFICATION OF CHANGE TO</b>	
Emptying .....	9-46	<b>NAME AND ADDRESS .....</b>	<b>20-1</b>
Emptying with Optional Features .....	9-46	<b>INDEX .....</b>	<b>21-1</b>
Cleaning and Maintenance .....	9-47		
Toilet Bowl .....	9-47		
Waste Holding Tank .....	9-47		
Winter Operation .....	9-48		
Toilet Unit Malfunctions .....	9-48		
Teleco TV Aerial .....	9-49		
How to use your TV Aerial .....	9-51		
Digital TV set-up Guide .....	9-51		
Connect Aerial and Power .....	9-51		
Troubleshooting Guide .....	9-51		
How To Make Up Your Beds .....	9-53		
Whale Easi-Slide Socket .....	9-54		
Safety Information .....	9-54		
Safety .....	9-54		



## WELCOME & INTRODUCTION

Thank you for selecting your new motorhome.

Before you drive off, please familiarise yourself with the motorhome and read this owners' handbook. This will help you to obtain the maximum pleasure from your vehicle and avoid endangering yourself and others, refer to the base vehicle user handbook supplied with your motorhome.

Additional information and detailed appliance instruction manuals are also contained in your Owner's Information Pack.

**Your new motorhome has been designed as a recreational vehicle and is intended for recreational use only. It is not intended for business use or for permanent habitation. Elddis accepts no liability if the motorhome is used for any purpose other than recreational/holiday use. Any use other than recreational/holiday use will invalidate your warranty.**

**Please Note:** All Elddis motorhomes are classified as Grade 3 and therefore meet with the thermal insulation and heat levels for specific climatic conditions as specified within the British and European Standard BS EN 1646 part 1.

By following the instructions provided in this handbook and maintaining your motorhome in a first class roadworthy condition, you are sure to have many years of carefree use. To ensure the very best quality and reliability all motorhome designs and new developments are rigorously tested. Therefore Elddis will accept no liability or uphold the warranty if the motorhome is altered or modified in any way that would adversely affect the reliability.

### IMPORTANT

The VIN number of your motorhome must be quoted in all correspondence, it can be found on a plate fixed next to the chassis plate within the engine compartment.

The vehicle VIN number should be quoted in any communications with the base vehicle manufacturer.

Changing market and supply situations may prevent us from maintaining the exact specification details in this guide and we therefore reserve the right to alter specifications as materials and conditions demand and if necessary supply an alternative.

***Enjoy your new motorhome.***

**IMPORTANT: Register your vehicle with us**

**In order to fully protect your valuable purchase, we would kindly ask you to take a few moments to complete our online Warranty Registration.**

Registering your vehicle will ensure that we always have the most accurate and up-to-date contact information and all of your vehicle details to hand, should you ever need our assistance.

Your feedback is incredibly important to us and helps shape the future of our leisure vehicles. We would be delighted if you would also complete our accompanying online Customer Questionnaire.

Both our **Registration** form and our **Customer Questionnaire** can be found on our Homepage: [www.elddis.co.uk](http://www.elddis.co.uk)

**Please note that this is not for warranty purposes, warranty registrations must be done by the selling retailer.**

### End Of Life Vehicle Directive

Your new motorhome fully complies with the European Directive on the End of Life Vehicles. In order to obtain information on how to dispose of your motorhome at the end of its life please visit the base vehicle manufacturer website. The base vehicle manufacturer website contains full details on all base vehicle manufacturer products together with details of their environmental and recycling policies.



## **Elddis Technical Approvals**

All Elddis Motorhomes have been European Commission Whole Vehicle Type Approved. In order to ensure your new motorhome is safe to use, Elddis are members of and have been inspected by the following bodies.

NCC who operate a certification scheme to ensure compliance with the European safety standards for motorhomes.

Elddis has also obtained ISO 9001.2015 accreditation and this is periodically audited.

**Please note:** Elddis Motorhome model year.

Elddis model year starts on the 1st September and runs to the 31st of August.



## GENERAL SAFETY

### Please read before using your new motorhome.

In order for you to get the most out of your new motorhome it is necessary for you to be aware of the following:

- (i) Do not obstruct ventilators (See Safety Section - Ventilation)
- (ii) Inspect the flexible gas hose regularly for deterioration and renew as necessary, with approved type, as and in any case no later than the expiry date stated on the hose.
- (iii) Never use portable cooking or heating equipment inside your motorhome. Do not use your fitted cooking equipment as heating at any time.
- (iv) Never allow modification to your gas or electrical system unless qualified persons carry them out. A Gas Safe Register™ approved gas fitter should carry out all modification to the gas system. Any modifications carried out on the electrical system should be carried out by a suitably qualified electrician.
- (v) Never exceed your motorhome's Maximum Technical Permissible Laden Mass.
- (vi) Never exceed the front or rear axle maximum load as specified by the weight plate under the bonnet.
- (vii) Pull out/lift up worktop extensions, where fitted, are only designed to take maximum weight of 6kgs.
- (viii) Please ensure extra care when young children use high level bunks and always use the safety nets and lift up flaps provided.
- (ix) With the exception of the Alde heating system ensure all the gas taps for the appliances are turned off before travelling.
- (x) If you suspect there is a gas leak please open all the windows then vacate the motorhome. Switch off the gas supply if it is safe to do so. Then contact your nearest Elddis Retailer to arrange for them to check the gas system.
- (xi) Do not leave children under 14 years of age unattended in your motorhome.

- (xii) Only those seats designated for travelling should be occupied when the motorhome is in motion.
- (xiii) Please note that motorhomes are covered by the seat belt regulations, which came into force in October 2006. These require children that are under 12 years old and also under 135cm in height to be seated in either child seats or on bolster cushions.
- (xiv) Ensure you remove all items from the microwave before travelling.
- (xv) It is essential that you have securely closed and locked the habitation door before setting off on any journey.
- (xvi) Where a dividing curtain is fitted or provided, please ensure when not in use it is stored in the position furthest away from any cooking equipment or in the storage housing if provided.

### Proper And Safe Use Of Storage Areas In Motorhomes

The storage areas provided in your motorhome are designed solely for the purpose of carrying personal possessions; these areas must not be used:

- As a habitation area (e.g. living, sleeping or cooking).
- To carry passengers, animals or livestock.
- For the installation (or use) of any LPG gas operated appliances, (unless supplied fitted by the manufacturer).
- For carrying LPG gas bottle cylinders, (unless designated by the manufacturer).
- To carry any flammable liquids, (unless properly stored, sealed and secured).
- For the operation of an electrical generator.
- In such a way that the loading exceeds the payload limit, as defined by the manufacturer.
- Such that the weight distribution of the vehicle means non-compliance with the vehicle axle loads.



## VENTILATION

All motorhomes manufactured by Elddis are ventilated at both high and low level in accordance with BS EN 721 Safety Ventilation. The fixed ventilation points fitted in your motorhome must not be blocked under any circumstances as your safety may depend upon them. It is advisable that the fixed ventilation points are checked and cleaned (where necessary) on a regular basis.

### High-Level Ventilation

This is mainly provided by fixed ventilation within the fitted roof skylight. These roof skylights should be cleaned annually by use of a small brush to remove any dust that may have accumulated around the mesh fitted. On some roof skylights the mesh can be easily removed to aid cleaning. On fan-assisted roof skylights it is essential that the fan is switched off prior to cleaning.

High level ventilation may also be provided by additional fitted mushroom vents.

### Low-Level Ventilation

All Elddis Motorhomes have fixed low level ventilation provided. These ventilators are covered with plastic covers designed to prevent them from being obstructed by items placed within the bed box. These covers can be removed by undoing the two screws in order to facilitate cleaning the ventilators, however these covers must be replaced once cleaning is completed.

It is essential for your safety that these ventilators are not blocked at any time.

### Ventilation in Separate Bedrooms

In motorhomes with separated sleeping areas, separate ventilation is required and is provided via a roof skylight at high level and a ventilator at low level.

### Gas Dispersal Holes

All appliances and gas unions have a gas dispersal hole within the same compartment. It is essential that these are not blocked or made ineffective.

## FIRE SAFETY

### Fire Extinguishers

It is recommended that one dry powder fire extinguisher complying with EN 3-7 of at least 1kg capacity or equivalent is provided by the main door, and a fire blanket next to the cooker. Familiarise yourself with the instruction on your fire extinguisher and the local fire precaution arrangements.

### In Case Of Fire

- (i) Get everyone out of the motorhome as quickly as possible using whichever exit is quickest including windows. Do not stop to collect any personal items.
- (ii) Raise the alarm. Call the fire brigade.
- (iii) Turn off gas container valve if safe to do so.
- (iv) Retreat to a safe distance.

### Fire Retardant Foams

All motorhomes are equipped with Polyurethane (PU) foam which are combustion modified foam cushions, foam mattresses and fire retardant fabric. All furnishings and fabrics used by Elddis comply with the Furniture and Furnishings (Fire Safety) Regulations. In addition all upholstery is made of fire retardant fabric.

### Habitation Door

**Note:** Please ensure you only remove the key from the door with the key in the vertical position (12 o'clock).



## PREPARING FOR THE ROAD

Before venturing out on to the road with your motorhome, it is important that you prepare correctly.

### MOTORHOME WEIGHTS EXPLAINED

#### Mass in Running Order

The weight of your motorhome as it leaves the factory, as new with standard fixtures and fittings, plus an allowance for the driver of 75kgs, the mass of the fuel when the tank is full and an allowance of 10kgs per gas bottle, the number of gas bottles equal to the number of connections provided at the regulator.

#### Maximum Technically Permissible Laden Mass

The maximum mass the vehicle can be when fully laden for use on the road.

#### User Payload

The load margin (payload), this represents the difference between the Mass in Running Order and the Maximum Technically Permissible Laden Mass. It shows the maximum weight that can be loaded into your motorhome, covering items such as food, crockery, cutlery, clothing, bedding, etc.

#### Loading

It should be noted that even weight distribution is a major factor in making your motorhome an easy and pleasant vehicle to drive. Care should therefore be taken in balancing the load, ensuring that heavy items are well spaced and are in as low a position as possible, for example, low cupboards and bed boxes.

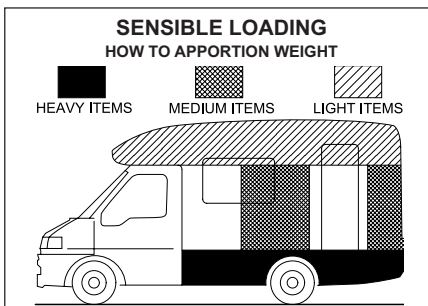

**Note:** Light items are considered as clothing and bedding. It is not recommended to travel with tinned items in overhead lockers.

**IMPORTANT: Do not exceed maximum technical permissible laden mass for your motorhome.**

### BEFORE MOVING OFF

Whenever making a journey with your motorhome, either setting off on holiday or returning home, it is good practice to run through this simple checklist.

- (i) Close and secure all cupboards and drawers and secure any loose articles.
- (ii) Do not store tins, bottles, etc. in overhead lockers.
- (iii) **Close and secure all windows and roof lights.**
- (iv) Leave all curtains and blinds open to aid visibility.
- (v) Check that gas cylinders are securely fastened and that the valve on the gas cylinder is turned off. Also ensure that the gas locker door is securely locked.
- (vi) Turn off all gas appliances.
- (vii) Switch off 240volt supply at source; disconnect mains cable and store in an appropriate place.
- (viii) Check that the battery is secure and that the battery box lid is sealed and secure.
- (ix) Ensure the fridge is on 12V operation and door lock is set. (Note: the electrical relays will allow the fridge to be run on the vehicle battery when the engine is running.)
- (x) Remove any external fresh water connections etc.
- (xi) Make sure any heavy articles are stored in accordance with the loading procedure.
- (xii) Lock habitation doors when travelling. We would recommend that all exterior doors, including the entrance door and access doors are firmly closed and locked prior to your departure.



- (xiii) Check your external rear view mirrors and adjust if necessary.
- (xiv) If a step is used, ensure it is put away before moving off.
- (xv) Your new Elddis motorhome has been designed to carry passengers in designated passenger seats only. The fitting of a 3-point seat belt can identify these seats. Any seat not fitted with a 3point seat belt is not designated as a passenger seat.
- (xvi) Ensure all tables have been stored in their designated table storage position.
- (xvii) Ensure you remove all items from the microwave (if fitted).
- (xviii) Check all the road lights are operational.
- (xix) Ensure the hob lid is in the closed position.

## **Pulling Off**

- Pull away smoothly.
- Avoid wear and tear on clutch and transmission by taking extra care.
- Change gears smoothly.
- Try not to jerk the clutch.

## **Bicycle Racks**

Your motorhome is fitted with bike rack rails. The rails are compatible with the Fiamma carry-bike pro M.

Fitting a bicycle rack to the rear panel of a motorhome will affect how weight is distributed. There are restraints to be aware of with such fitments.

The maximum loading allowed on the back panel is 60 kgs including the weight of the bike rack and bicycles.

The motorhome must also be balanced to take into account the new weight distribution. Weight must be distributed evenly.

Elddis cannot be held responsible for problems related to a bicycle rack fitted by a third party.

## **Tow Bars**

Your new Elddis motorhome has been designed to accept a type approved tow bar. Full details on fitment are available upon request from Elddis.





## MOTORWAY HANDLING

### Best Practice

To gain the most enjoyment and ensure a long life for your motorhome, the following should be observed:

- Do not bump kerbs with wheels.
- When overtaking ensure sufficient clearance is given to other vehicles.
- Your motorhome will not accelerate as quickly as a car, so take this into account when attempting to overtake other vehicles.
- Carry out all manoeuvres as smoothly as possible.
- Use the wing mirror to check your motorhome has cleared the other vehicle.
- Slow down and take care when driving over raised speed bumps, 'sleeping policemen' or when embarking/disembarking ferries.
- In high or cross winds, travelling downhill or in conditions of poor visibility reduce your speed.
- High-sided vehicles can cause air buffeting so extra care must be taken when passing or being passed. Leave as much space as possible when overtaking these types of vehicles

### Speed Limits

Be sure to observe all statutory speed limits and adapt your speed to take account of prevailing weather and road conditions.

### Towing Your Motorhome

In the unlikely event that you have to tow your motorhome. Please refer to the base vehicle information for details on where to find the tow point and tow hook.





## ARRIVING ON SITE

### CHECK SITE REGULATIONS

On arrival at a campsite, you should always check the site regulations. This will help avoid any unnecessary conflict with site management and other site users.

### SELECTING A PITCH

Carefully select where you wish to place your motorhome. The site should be as level as possible, preferably not under or near trees, well drained and away from possible boggy areas. Consider how you will move the motorhome when it is time to leave the site. On sloping ground it is better to pitch facing downhill, especially during wet weather.

### LATERAL LEVELLING (SIDE TO SIDE)

A quick glance at your pitch should tell you if you are likely to need side to side levelling i.e. levelling across the axle. On uneven ground lateral levelling is accomplished by the use of a leveler jack or ramp and a spirit level placed 'across' the motorhome floor.

### LEVELLER JACK

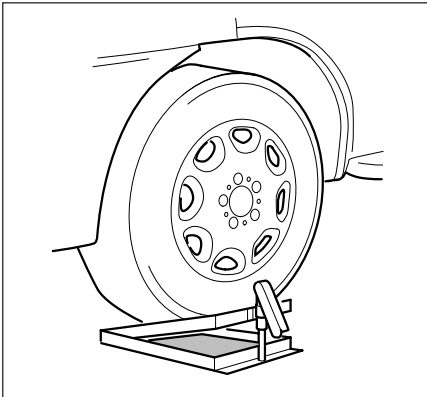

Place the leveller jack, folded flat, in front of the wheel that is to be raised to level the axle. Drive the motorhome onto the leveler jack and adjust the height until the spirit level shows that the motorhome is laterally level.

## RAMP

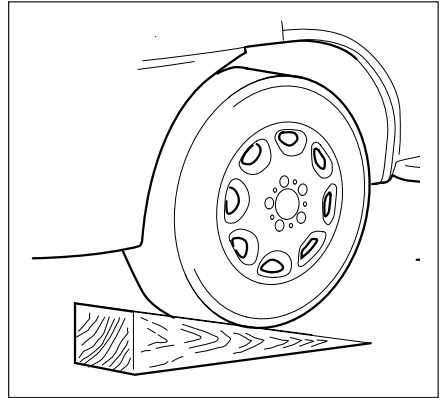

Reverse onto your pitch about a foot further back than you wish to end up. Then place the levelling ramp in front of the wheel that needs to be raised.

Place a spirit level parallel to the axle or just inside the motorhome door. It helps to have two people at this point. One should drive the motorhome very slowly forward moving the wheel up the ramp, and the other should indicate when the spirit level bubble is in the middle.

Whichever method you use, once level, apply the motorhome handbrake and chock the motorhome wheel if necessary.





## GETTING STARTED

You have arrived at your destination and now want to start to enjoy your new Elddis motorhome. The following is a step by step guide to connecting your services and getting everything in your motorhome working.

### ELECTRICITY

#### Power Supply Charger

Your motorhome is fitted with a power supply/charger. This will charge the leisure battery "where supplied" when fitted and also power the 12V systems.

A leisure battery must be fitted to the motorhome at all times.

The Charger is fully automatic and will not overcharge the leisure battery.

#### 12v Systems:

When connected to the 230V site supply the automatic Power Supply/Charger will charge the leisure battery and power the 12V systems.

When the ignition is switched on the 12V system in the motorhome is automatically switched off, vehicle power is supplied to the refrigerator.

#### GENERATOR/CHARGER

When connecting to a generator, always switch off the RCD, start the generator and allow running for a few minutes to stabilise. When this has happened, switch the RCD to the ON position.

#### ELECTRICITY MAINS SUPPLY

Your motorhome's main electrical installation is designed to run on 230V at 50 hertz AC supply.

#### CONNECTING TO MAINS SUPPLY ON ARRIVAL AT SITE

Before connecting the motorhome installation to the mains supply, check that:

- (i) The mains supply is suitable for your installation and appliances, i.e. whether it is AC or DC and whether it is at the correct voltage and frequency.

- (ii) Your motorhome is properly earthed. Never accept a supply from a socket outlet or plug having only two pins, or from a lighting outlet.
- (iii) Any residual current device (earth leakage circuit breaker) in the mains supply to the motorhome has been tested within the last month. In case of doubt, consult the site owner or their agent.
- (iv) Make sure that the switch at the site supply point is off and that all electrical equipment in the motorhome is switched off by ensuring your motorhome mains isolating switch on the MCB is in the 'OFF' position.

Once the above checks have been made:

- (v) Remove any cover to the electricity inlet provided on the motorhome and insert the female connector of the flexible orange supply cable as shown.

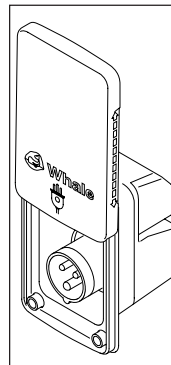

- (vi) Locate the site supply and remove any cover from the socket outlet provided at the supply point. Insert the male plug at the other end of the flexible orange supply cable. Switch on the main switch at the site supply point (if appropriate).

- (vii) Place any surplus cable under the motorhome. Ensure that the surplus cable is not coiled up as it could overheat.

- (viii) The MCB main electricity supply switch should be put in the 'ON' position.
- (ix) Check the RCD is working by pressing the test button. Once pressed all electrical lights and appliances should cease to operate. Reset and then check the electrical system is operational.



## WIRING OF CONNECTING CABLE AND MOTORHOMES MAINS INLET

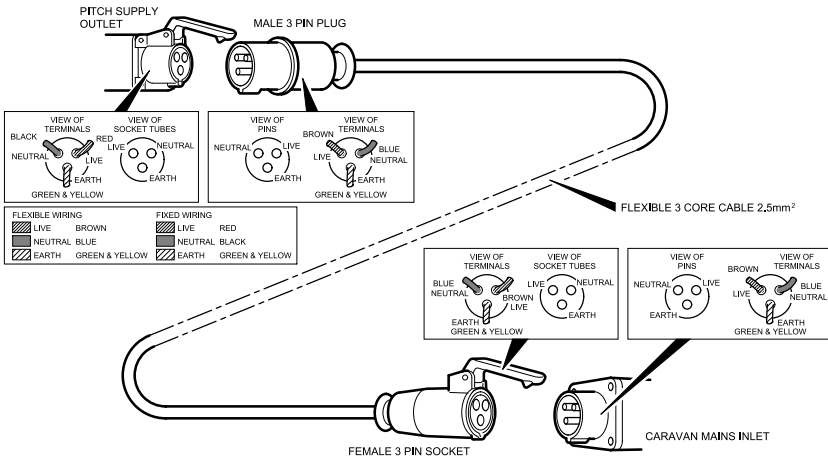

**WARNING:** It is essential that connections are made exactly as shown. If terminal markings are not in accordance with the above diagram they must be ignored.

- (vii) Place any surplus cable under the motorhome. Ensure that the surplus cable is not coiled up as it could overheat.
- (viii) The MCB main electricity supply switch should be put in the 'ON' position.
- (ix) Check the RCD is working by pressing the test button. Once pressed all electrical lights and appliances should cease to operate. Reset, and then check the electrical system is operational.
- (x) Finally in order to get your 12V system operational, ensure the master 12V switch is in the 'ON' position.

### DISCONNECTING MAINS SUPPLY WHEN LEAVING SITE

- (i) Switch 'OFF' the RCD in the motorhomes distribution unit.
- (ii) Remove the male 3 pin plug from the site supply.
- (iii) Disconnect the female 3 pin plug from the motorhome and store the cable in an appropriate locker.

### OVERSEAS ELECTRICAL CONNECTION

**Please Note:** Connection to a mains voltage supply OVERSEAS requires particular attention.

Care must be taken when connecting supplies abroad since the supplies can be of REVERSE POLARITY.

The significance of REVERSE POLARITY is that when equipment is switched off, it may not be electrically isolated. The only certain way of making equipment safe is to unplug it.

A means of checking the polarity of the mains supply when overseas is recommended. There are available several proprietary makes of equipment for the purpose.

If it can be achieved, it is preferable to connect live to live and neutral to neutral to maintain full electrical protection.

CHECK all motorhome equipment is set-up to accept the site supply before actually switching on.



## GAS SUPPLY





Your motorhome is designed to operate using either propane or butane liquefied petroleum gas at 30M/bar. Gas can be obtained from your motorhome dealer. Your motorhome is designed to accept a maximum 2 x 6-7kg gas bottles.

### Connection

Make sure that heating and cooking appliances and gas cylinders are switched off.

Each gas appliance is connected to its own gas isolation tap. These are identified on the tap via a label. Below is a key to identify each label.

To operate the tap the arrow on the tap shows the direction of flow for the gas. There will be a small label next to the bank of taps, which is also reproduced below:

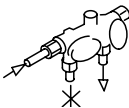
 Water Heater	 Cooking Appliance
 Space Heater	 Hob
 Refrigerator	 Gas On/Off

## Gas Regulator

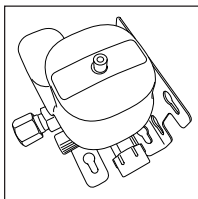

**Your Motorhome is fitted with a Road safe gas regulator.**

The operating instructions are given below.

### Intended use

The Truma SecuMotion gas-pressure regulator is a device that ensures uniform gas pressure (30 mbar) with a permissible inlet pressure range of 0.3 - 16 bar.

SecuMotion regulates and monitors the consumption of liquid gas. If the specified consumption is exceeded or if the pressure at the regulator outlet falls below 27 mbar (due to gas pipe break, for example), the integrated gas flow monitor will shut off the flow of gas. A high pressure hose with a hose-break safety device is essential for connecting the SecuMotion gas pressure regulator to the gas cylinder.

Truma offers hoses with common connection fittings to enable use of gas cylinders with various valve connection sizes.

**Your Motorhome has been supplied with a hose for connection to a propane gas bottle.**

The integrated overpressure safety device complies with the requirements for a commercial safety device against impermissible pressure increases throughout Europe, a type tested liquefied-gas heating system **may be used** while driving (according to the EU directive 2001/56/EC) if the system includes a regulator with an appropriately configured gas installation.

Pressure regulating devices and hoses must be replaced with new ones no more than 10 years after their date of manufacture (every 8 years if used commercially). This is the responsibility of the operator.



## ROAD SAFE GAS REGULATOR

### Operating instructions

The use of upright gas cylinders from which gas is **taken in the gas phase** is mandatory for the operation of gas regulators, gas equipment and gas systems. Gas cylinders from which gas is taken in the liquid phase (e.g. for fork lifts) must not be used, since they would result in damage to the gas system.

### Taking into operation

Open gas remote switch if present.

1. Open the cylinder's valve.
2. Firmly press the green reset button on the high pressure hose.
3. Press gas flow monitor reset button (green button) on gas pressure regulator **slowly**.
4. Release gas flow monitor reset button (green button) on gas pressure regulator **slowly** (3 seconds). If no pressure point is felt when the button is pressed again, the regulator is ready for operation (repeat procedure if necessary). Start the gas-burning devices if desired. If the gas cylinders are closed, SecuMotion may switch off after an extended period of no usage.

### Changing a gas cylinder

Please use the included screwing tool to attach and remove the high pressure hoses. It will help you generate the necessary tightening torque and will prevent damage to the screw fittings, which may otherwise result from using an improper tool.

When the cylinder is connected please ensure that the high pressure hose is not placed under any strain.

### Residual gas: No smoking! No open flames!

- Close the empty gas cylinder's valve.
- Remove the high pressure hose from the gas cylinder and remove the clip-on adapter, if present.
- Attach the high pressure hose to the full gas cylinder and apply the clip-on adapter, if present.

- Open the full cylinder's valve.
- Press the hose-break safety device and the gas-flow monitor (see "Taking into operation").

Anytime after making changes, check the hose connection to the cylinder valve for leaks (see "Checking for leaks in the high pressure area").

### Exchanging hoses.

Please use the included screwing tool to attach and remove the high pressure hoses. It will help you generate the necessary tightening torque and will prevent damage to the screw fittings, which may otherwise result from using an improper tool.

### Residual gas: No smoking! No open flames!

- Close the gas cylinder's valve.
- Remove the high pressure hose from the gas cylinder (or from the slip-on adapter) and from the regulator inlet.

When performing a hose change, please ensure that the white gasket provided with the hose (hose outlet - regulator inlet) is correctly installed and not damaged.

We recommend that the gasket (part no. 50020-76300) be replaced with every hose change.

- Screw country-specific high pressure hose to SecuMotion inlet and cylinder (or to adapter).

### Open the gas cylinder's valve.

- Press the hose-break safety device and, if necessary, the gas-flow monitor (see "Taking into operation").

Anytime after making changes, check the hose connections to the cylinder valve and to the inlet of the SecuMotion gas-pressure regulator for leaks.





## High Pressure Gas Hoses

You should only connect to this regulator using a length of approved high-pressure hose not exceeding 450mm from the gas cylinder to the regulator. These approved high-pressure hoses are available from your Elddis Retailer. These hoses are connected using screw thread fittings, which will make a seal if connected and tightened using a spanner. Once the hose is securely connected turn on the gas tap above the regulator, then turn on the gas bottle to allow gas to flow into the motorhome.

In order to make all your motorhome gas appliances operational it is necessary to open each appliance gas tap as detailed in previous column. All your gas appliances should now be operational. Instructions on how to use each appliance are detailed later in your handbook.

**WARNING: Aerosols and highly flammable liquids must not be stored in the compartment behind, or adjacent to, any gas appliance. Some industrial LPG appliances operate at high pressure and require a 'high pressure' regulator. This often has an adjusting handle on it. NEVER use such a regulator on a motorhome.**

**Ventilation holes must be clear at all times.**

## WATER SYSTEM

### Filling your fresh water tank

Your motorhome is fitted with a standard water inlet which can be filled using a hose pipe connected to a tap placed into the water filler point.

Please take care not to over fill your tank it is advised that someone monitors the water level in the tank while filling is in progress.

### Waste Water Tank

Your new motorhome is also fitted with a waste water tank. All waste water excluding the toilet waste will run into the waste water tank. The level of water in the tank can be monitored using the control panel. Opening the grey waste outlet provided on the outside of the motorhome empties the tank. Open the tap when the outlet is over a drain and the water will run out of the tank.

### Draining Down Your Water System

- (i) It is essential that you drain down your motorhome water system when it is not in use. This is most important during winter months to protect against frost damage
- (ii) Disconnect the water pump and switch off power supply.
- (iii) Open the safety drain valve on the water heater located next to the water heater.
- (iv) Open all taps and remove all plugs from sinks and showers. Lever operated taps should have the lever put into the up and central position.
- (v) Open both the blue and grey drain outlets on the outside of your motorhome.
- (vi) Adjust the level of the motorhome to ensure that the drain outlet is at the lowest point of the motorhome.

After 30 minutes level the motorhome and prepare it for storage if necessary.





## **GAS SAFETY ADVICE**

In the event of a suspected gas leak the gas must be turned off using the isolation valve on the gas bottle. A competent gas fitter should then check the system before it is used/reused.

Regularly check flexible gas hose, joints and connections for tightness. Finally, make sure that each gas appliance is working efficiently to the recommendations of the appliance manufacturers.

See Index - Ventilation

## **FACTS ABOUT LPG**

- LPG is not poisonous.
- Bi-products of incomplete combustion are harmful to health.
- LPG is dangerous if all air and oxygen is excluded.
- LPG has been given a smell by the manufacturers in order to identify leaks.
- The gas is heavier than air and therefore sinks to the lowest point.

## **AWNING SPACES, LPG AND APPLIANCE EXHAUST**

Using a refrigerator on gas which vents into an enclosed awning space must only be done if there is sufficient ventilation to prevent the build up of CO<sub>2</sub>.

Space and Water heaters may produce sufficient amounts of CO<sub>2</sub> to pollute the awning space, if it is totally enclosed and therefore **MUST NOT BE** used on gas when an awning is attached.

**Please note:** Ventilation holes must be clear at all times.

## **LPG GAS SYSTEM**

Elddis does not recommend the use of any external cylinders. All cylinders in use should be within the gas locker provided.

Please ensure that you have read the operating instructions for each gas appliance contained in your Owners Information Pack. Please ensure that any gas hose left unconnected is protected from dirt or other foreign bodies entering the hose.

## **WARNINGS**

- **Fresh air circulation should be allowed below the motorhome when appliances are in use and when flues terminate below the floor to allow free evacuation of the products of combustion. At least three sides of the underfloor space should always be kept open and unobstructed especially by snow. Do not make any additional openings in the floor.**
- **No appliance shall be used outside when connected to an internal outlet.**
- **Maintain adequate spacing of combustible materials from sources of heat or naked flame.**
- **Do not use additional independent gas appliances inside the motorhome.**





## ELECTRICAL SYSTEM

### 12v POWER SUPPLY

#### Battery Installation

Your motorhome will be fitted with a charging and power distribution unit.

When installing the leisure battery please ensure that it is placed on the battery tray supplied with your motorhome. Then place the tray in the battery locker of your motorhome. Connect the battery to the clamp fittings connected to the connection leads within the battery compartment.

We recommend that you refer to the NCC approved battery scheme, which can be found at [www.thencc.org.uk](http://www.thencc.org.uk).

#### Battery Maintenance

##### Storage

Ensure that the leisure battery is fully charged before placing the vehicle into storage.

Check the battery state every month, if the terminal voltage drops below 12.07V then re-charging is necessary.

Charging should be carried out in a cool, dry well ventilated area.

**CAUTION:** Your Thatcham alarm system is powered by the leisure battery. Therefore it is recommended that a battery is installed at all times. Failure to do so could void your insurance policy.

Do not place the battery onto cold surfaces such as concrete as this will affect the battery's ability to charge.

##### Points to remember

- Prolonged discharge causes harmful sulfation and may damage a battery.
- For peak performance never let a battery sit discharged for long periods of time.
- Over discharged batteries are permanently damaged and need to be replaced.

**Note:** Do not over discharge the battery. One of the most common causes of battery failure is when the battery is discharged below the recommended level of approximately 12.2v -

ref table. Discharging a battery below this figure will cause permanent damage. Overheating and gassing will occur when re-connected to the mains supply.

	12 Volt Battery	State of Charge
Good	12.7V	100%
	12.5V	90%
OK	12.42V	80%
	12.32V	70%
	12.20V	60%
	12.06V	50%
Warning	11.9V	40%
	11.75V	30%
	11.58V	20%
Damaged	11.31V	10%
	10.5V	0%

**Good:** the battery is in good condition and not in need of charging

**OK:** nothing to worry about but put the battery on charge as soon as you can

**Warning:** get the battery on charge as soon as you can. Leave it and the battery will be damaged, possibly beyond repair

**Damaged:** Replace battery

#### Generators / Charger

All electrical equipment fitted in your new motorhome can be run from either a controlled generator or charger whose output is maintained between 11volts and 14volts.

At least once every 3 years, the motorhome electrical installation should be inspected and tested, and a report on its condition obtained, as prescribed in British Standard BS7671.

### 230v POWER SUPPLY

#### Mains Unit

The Mains Unit replaces the conventional fuse box. Similar, but larger ones are often fitted in new houses. The unit provides overload and earth leakage protection for the 230V electrical supply in your motorhome.

For normal operation all switches on the unit need to be in the ON position. The switches on the left of the unit are known as MCB's (miniature circuit breakers). These take the place of the conventional fuse but are more



convenient. In the event of a fault the MCB 'trips' i.e. automatically moves to the OFF position. After elimination of the fault the MCB can be re-set by switching to the ON position (against the spring pressure in an upwards direction). If an earth fault develops, or a person was to touch a live piece of equipment, the leakage of current to earth should immediately operate the RCD (residual current device) and 'trip' the main switch, to the OFF position. This switch can only be re-set after elimination of the fault.

**Please note:** In case of difficulty, consult an approved electrical installation contractor (who may be the local electricity board). It is dangerous to attempt modifications and additions yourself.

**CAUTION:** Lamp holder-plugs (bayonet- cap adaptors) should not be used under any circumstances.

### Resetting the RCD

To re-set, operate the switch as for MCB's. Periodically, the RCD should be checked by operating the test button marked 'T'. The unit should immediately switch to the OFF position. If the unit does not switch off then a qualified electrician should be consulted. If the unit does switch off, the test is complete and the switch can be re-set restoring the supply back to normal.

**Please note:** Simultaneous operation of all of the 230V mains electrical equipment may not be possible. A typical UK site mains hook-up point provides a maximum output of 16 amps and on some continental sites the available output may be as low as 5 amps. If your loading exceeds the site supply it may trip the site circuit breaker. Please check the available mains output with your site operator. The following items need to be added together if used simultaneously.

230V mains equipment typical consumption figures:

- Refrigerator ..... 0.50 amps
- Charger ..... 0.50 amps
- Combi heaters ..... 13 amps
- Colour TV ..... 3.33 amps

### AUTOMATIC CHARGING SYSTEM

The battery charger will operate automatically when the motorhome is connected to the mains outlet on a motorhome site.

**Note:** The charging unit will charge both vehicle and leisure battery.

When the motorhome engine is running the 12V system will not operate with the exception of the 12V refrigerator.

### SCHAUDT WA 121525 BOOSTER UNIT

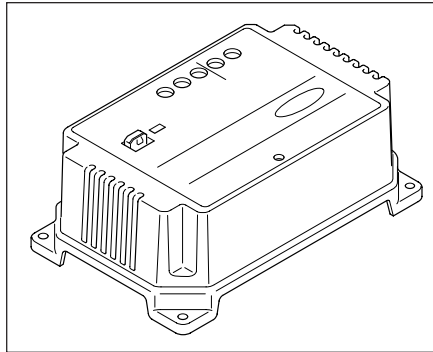

#### General

Your vehicle may be fitted with a Schaudt booster unit which is only required if the base vehicle is fitted with a smart alternator.

The unit does not require any interaction from the end user or require any maintenance and will simply function as its intended, during the normal operation of the vehicle.

#### Function

The WA 121525 Booster is used for the optimum charging of leisure batteries such as lead-acid, led-gel, AGM & lithium.

The main purpose of the booster is to ensure the leisure battery remains charged whilst the vehicle is in motion.

Your vehicle may be fitted with a smart energy saving alternator, this is engine/base vehicle dependant. The charge voltage for these alternators varies greatly depending on the driving state. Without a booster fitted, the vehicle leisure batteries are at risk of discharge whilst the vehicle is in motion.



## Location

The location of the booster will vary depending on each vehicle layout, but will always be located within 1m of the vehicle's power distribution unit.

Please contact Erwin Hymer Group UK Ltd if any further information is required regarding this product.

CHECK all motorhome equipment is set-up to accept the site supply before actually switching on.

## INTERNAL LIGHTS

Your new motorhome is fitted with all LED lighting.

You should not need to replace these long life lights, however should the need arrive please only replace these lights with identical lights which are available from your Elddis retailer.

## MAXIMUM BULB RATINGS FOR INTERNAL LIGHTS

Type of Light	Maximum Bulb Rating
Downlighters .....	1.2 watts
Reading lights .....	1.2 watts
Floor LED .....	0.36 watts
Awning lights .....	5 watts

LED tape is used as backlit mood lighting. The wattage varies from 4.8 to 9.6W depending on the location within the vehicle.

**Please note:** Ensure that you only replace a blown bulb with one of the same rating. Never replace a bulb with one with a higher rating. You should ensure that when fitted, no bulb is in contact with the surface of the lamp or shade.

**Note:** All LED lights can only be replaced with a new complete unit and not a replacement bulb.

**CAUTION:** Do not look directly at LED lights.

## MAINS UNIT - ENCORE

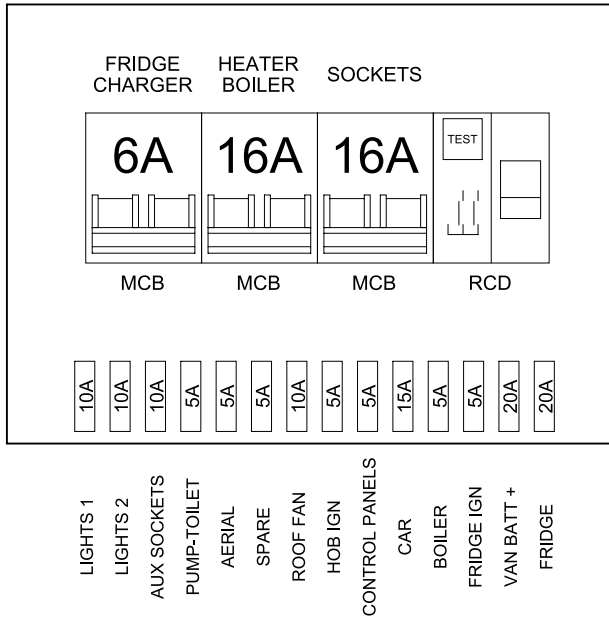







## HOW TO USE YOUR MOTORHOMES EQUIPMENT

Within this section of your motorhomes handbook we will give you brief details on how to operate all of the motorhomes equipment from the gas cooking equipment to the window blinds. For further details on the major equipment within your motorhome please read the individual appliance instructions contained with your user information pack.

**Please note:** Before attempting to use any gas equipment please ensure that the gas bottle is connected securely to the motorhomes regulator via a high pressure gas hose and the bottle valve is in the on position. Also ensure the appliance isolation valves are in the on position as shown in the gas system section.

**Please note:** Before attempting to use any electrical appliance please ensure that you have connected the mains connection cable to a mains hook up and that the mains isolation switch is in the on position. Ensure the 12V master switch is in the ON position. This is found in the side of the unit next to the entrance door.

## HOW TO OPERATE YOUR MOTORHOME ENTRANCE DOOR

### From the Outside

It is recommended that you always lock and unlock your Encore habitation door via the use of the key fob.

Once you have unlocked the entrance door, to open the door pull the lever shown opposite.

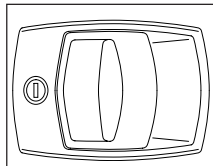

### From the inside

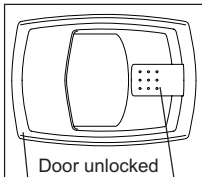

Door unlocked

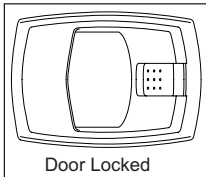

Door Locked

Large Lever

Locking Button

### Opening the door

Pull the large lever towards you and if locked, the locking button will release. Pull the large lever towards you again and the door will open.

### To close and lock your door

Pull the door closed to ensure it is fully latched so that no visible light can be seen past the door seal.

Now depress the locking button which can be found in the centre of the handle.

To check the door is locked, try pushing the door open without using the handle.

**It is important that the locking button is in the locked position before you start your journey.**

**Do not attempt to open or close the door while the vehicle is in motion.**



## Control panel

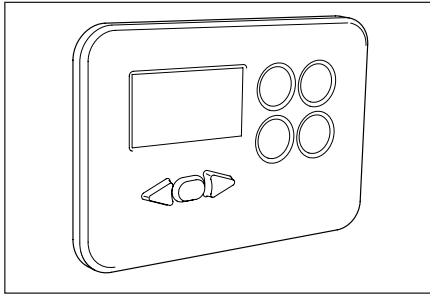

### Overview

The control panel provides the user with a central point to check:

- Leisure battery voltage
- Vehicle battery voltage
- Level in fresh water tank
- Level in waste water tank
- Current in Amps being drawn from the leisure battery
- Inside (Internal) temperature
- Outside (External) temperature
- Time

The control panel also provides the user with the ability to:

- Switch off all non-essential electrical appliances/accessories
- Switch off all the lights
- Switch off the pumps
- Switch off the awning light
- Force internal pump to run (For purging pipes)

The control panel has optional audio and visual warnings for:

- Low battery (Leisure)
- Low battery (Vehicle)
- Low level (Fresh water tank)
- High level (Waste water tank)
- High power drain (Leisure battery)
- 230V mains supply lost

## Circular Function Buttons

### Master Switch



When pressed will switch power to all non-essential accessories.

The alarm, radio and fridge still receive power when the master switch is off.

### Lights Switch



When pressed will switch power to all the interior lights.

If the master switch is off, this button will not function.

### Pump Switch

Also see Icons section for relevant warning icon



When pressed will enable/disable the water pumps.

Holding this button will force the internal pump to run.

If the master switch is off, this button will not function.



### Awning Switch



When pressed will switch power to the awning light.

If the master switch is off, this button will not function.

### Navigation buttons

Use  and  buttons to navigate.







Press  to enter function or change settings (if further settings are available).

## Screens

### Time

The time screen is displayed by default. The control panel will return to the time screen when left idle.

Setting the time:

1. On the time screen, hold  for 3 seconds until the hours begin to flash.
2. Keep pressing  or  to change hours.
3. Press  to set hours, minutes will now flash.
4. Keep pressing  or  to change minutes.
5. Press  to finish.



## Water Level

Also see "User Settings" -> "Water Low" for associated alarm"

Also see "Icons" section for associated icon



The level in the fresh water tank is displayed as a % on this screen.

## Waste Level

Also see "User Settings" -> "Water High" for associated alarm"

Also see "Icons" section for associated icon



The level in the waste water tank is displayed as a % on this screen.

## Internal Temperature



The inside temperature, as detected by a sensor inside the control panel, is displayed on this screen.

You can change between Celsius and degrees Fahrenheit by pressing and selecting for °C or for °F.

## Leisure Battery Amps

Also see "User Settings" -> "Amps High" for associated alarm.

Also see "Icons" section for associated icon.



The current being drawn from your leisure battery, in Amps, is displayed on this screen. A higher current will drain your battery faster.

To display current draw as a % of maximum recommended current press then .

**Note:** (0A = 0%) (12A = 100%)

You can return to displaying in Amps by pressing then .

## Leisure Battery Voltage

Also see "User Settings" -> "Low Volts V" for associated alarm.

Also see "User Settings" -> "Low Volts L" for associated alarm.

Also see "Icons" section for associated icons.



With 230V mains disconnected, this screen shows the voltage of the currently selected battery (set on "Select Battery" screen).

An estimate of your batteries' remaining charge can be seen by pressing then .

**Note:** (12V = 0%) (12.7V = 100%).

You can return to displaying in Volts by pressing then .

**Note:** To increase accuracy of the Voltage reading, switch the "Master Switch" off.

**Note:** The "Leisure Battery Voltage" actually displays the voltage of the charger while 230V mains is connected.



## Icons

There are a number of icons that can appear at the top of the time screen.

See below for a description of each icon.

Icon	Description
	Internal pump is running
	The leisure battery voltage is below 12.2V
	Over 12A of current is being drawn from the Leisure battery
	The water tank level is below 10%
	The waste tank is over 75% full
	The living space is being powered by your vehicles' battery rather than the leisure battery
	The 230V mains is connected.

## Warranty

If you believe there is a problem with your control panel please contact your dealer who will be able to help.



## OVEN, HOB AND GRILL

### Safety

- This appliance may be used by children aged 8 years or older and persons with reduced physical, sensory or mental capabilities and/or lack of experience and knowledge only if they are supervised or have been given instructions on the safe use of this appliance and understand the potential hazards.
- Keep children younger than 8 years away from the appliance, except under constant supervision.
- Do not allow children to play with the appliance.
- Do not allow children to clean or maintain this equipment unattended.
- Use only parts supplied by the manufacturer.
- Do not change or adjust anything on the appliance, unless the change is authorised by the manufacturer or its representative.
- If the power cord is damaged, it must be replaced by the manufacturer, its service agent or similarly qualified persons in order to avoid a hazard.
- Use the appliance for cooking only and not for anything else, for example room heating. This can lead to carbon monoxide poisoning and overheating. The manufacturer cannot be held liable for damage resulting from improper use or incorrect setting of the controls.
- This appliance is not intended to be operated by means of an external timer or separate remote-control system.
- The use of this gas cooking appliance results in the production of heat, moisture and products of combustion in the room in which it is installed. Ensure the room has sufficient ventilation when the appliance is in use. During prolonged use, additional ventilation may be needed by opening a window or increasing the extraction force of the hood.

- Never extinguish a cooking fire with water. Turn the burner off and cover the flame with a lid or a fire blanket.
- The burners and pan supports are hot during and after use. Allow all parts to cool before touching them, as this can cause serious injury.
- Unattended cooking on a hob with fat or oil can be dangerous and may result in fire. Do not leave the appliance unattended when in use.
- The use of inappropriate hob guards can cause accidents.
- Do not store items on the cooking surface of the hob.
- The food shelves and trays in the appliance are hot during and after use. Allow all parts to cool before touching them, as this can cause serious injury. Always use oven gloves when removing the shelves and trays.
- Do not store items in the appliance.
- Do not put heavy objects on the open appliance door.
- The appliance and accessible parts become hot when the grill is in use. Young children should be kept away.
- Caution: hot surfaces. Door must be open when grill is in use.

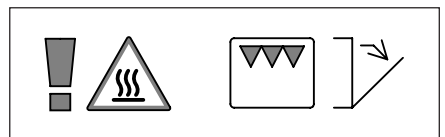

- In the event that abnormal drift in cooking temperature of the oven is observed, have the thermostat checked by a qualified service engineer.
- Care should be taken not to overload the oven, allowing adequate spacing to ensure free circulation of heat.
- Do not use steam cleaners or pressure washers to clean the appliance. See for instructions.
- Do not allow oil or fat to build up on the appliance. Clean the appliance after each use.



- **The glass lid may snap shut towards the end of lowering due to the travel-lock action of the hinges. Make sure all fingers are clear of the appliance when closing the lid.**
- **Do not use harsh abrasive cleaners or sharp metal scrapers to clean the surface of the glass, since they can scratch the glass surface which may result in shattering of the glass.**
- **Remove any spillage from the glass lid before opening the lid.**
- **Do not shut the glass lid when the burners are lit or still warm.**



- Clean the appliance with warm water and household detergent and dry carefully with a soft cloth.
- Ensure that the gas supply is connected and turned on.
- Ensure that the appliance is connected to the 12V DC battery for the spark ignition.
- Ensure that the pan supports are positioned properly.
- Ignite the gas burners and let them burn to expel odours and vapours first.
- Ignite the burner and heat the grill for about 20 minutes to eliminate any residual factory lubricants that might impart unpleasant smells to the food being cooked. Smoke may occur during this procedure. Open any windows and turn on mechanical ventilators to help remove the smoke.
- Ignite the burner and heat the oven for about 30 minutes at 200°C to eliminate any residual factory lubricants that might impart unpleasant smells to cooked food. Smoke may occur during this procedure. Open any windows and turn on mechanical ventilators to help remove the smoke.

## Dual Fuel only:

- Ensure the electricity is connected and switched on.
- Prime the hotplate by switching on the hotplate for a short period, without a pan, to harden and burn off the coating. Use a medium to high setting for 3-5 minutes. Allow adequate ventilation to disperse any smoke that occurs during this process. Allow the hotplate to cool.
- Season the hotplate by heating the hotplate for 30 seconds on a medium setting and then switching off. Pour a minimal amount of unsalted vegetable oil onto a clean dry cloth or paper towel and apply a thin coat of oil to the hotplate surface. Wipe off any excess oil, then heat the hotplate on a medium setting for 1 minute. Occasional seasoning will help to maintain the hotplate's appearance.

Only use LPG (Liquefied Petroleum Gas).



The appliance operates on propane or butane. Propane is preferred over butane, because butane provides poor performance at an ambient temperature below 10°C and cannot be used at an ambient temperature below 5°C.



## Use of the burners

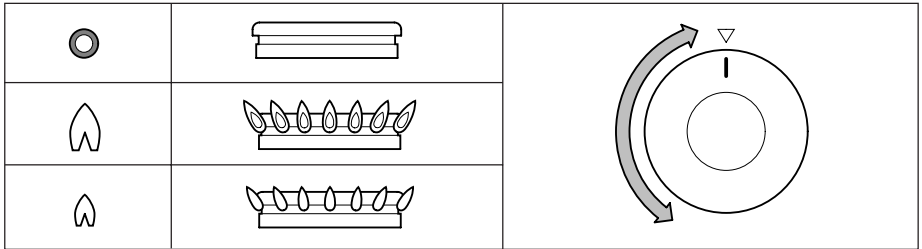

### Turning on:

- Push and turn the control knob.
- Turn the control knob anti-clockwise to the full rate position.
  - For spark ignition models: Push the ignition button.
  - For non-ignition models: Hold a lit match or gas match to the burners.
- Keep the control knob pressed for about 10-15 seconds and then release it.
- Adjust the height of the flame.

If the burner accidentally extinguishes turn the control knob to the 0 position and wait at least 1 minute before re-igniting the burner.

If the burner has not lit within 15 seconds turn the control knob back to the 0 position and release it. Wait at least 1 minute and repeat the steps above to turn on the appliance.

### Turning off:

- Turn the control knob clockwise to the 0 position to turn off the burner.



Always make sure the control knob is in the 0 position when you have finished using the gas burners.



Do not shut the glass lid when the burners are lit or still warm.

### Use of the electric hotplate (if applicable)

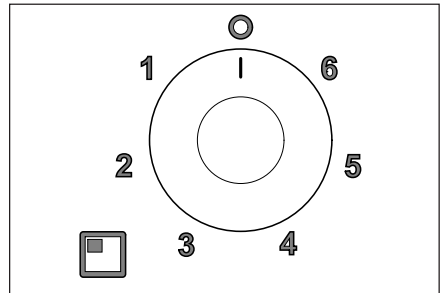

### Turning on:

- Rotate the control knob either clockwise or anti-clockwise to the required position (1-6).

For maximum efficiency, a correctly sized pan with a flat heavy gauge base should be used. The pan size should be the same or slightly larger than the hotplate (up to 1"/2.5cm oversize).

### Turning off:

- Turn the control knob to the 0 position to turn off the hotplate.



Always make sure the control knob is in the off position when you have finished using the hotplate.



Do not shut the glass lid when the hotplate is turned on or still warm.



## Use of the grill

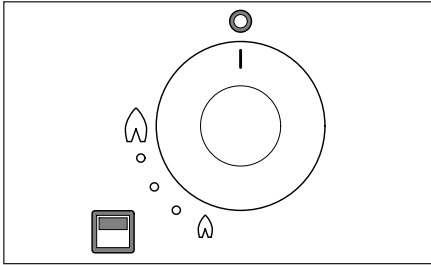

For the exact location of the control knob, see:

### Turning on:

- Open the door and push the control knob.
- Continue pressing the control knob and turn it anti-clockwise to the full rate position.
  - For spark ignition models: Push the ignition button.
  - For non-ignition models: Hold a lit match or gas match to the burner.
- Keep the control knob pressed for about 10-15 seconds and then release it.
- Adjust the required heat setting.
- Depending on the food to be cooked, the correct grilling height can be achieved by inverting the pan trivet into either the high or low position.
- The grill pan supplied is multi-functional, for use in grill or oven and the handle design allows removal or insertion whilst the pan is in use. Always remove the handle when the pan is in use.

The grill door must remain open when lighting and using the grill.

If the burner accidentally extinguishes turn the control knob to the 0 position and release it. Wait at least 1 minute and repeat the steps above to turn on the appliance.

Although the grill heats up quickly, it is recommended that a few minutes preheat be allowed.

It is normal for the flames on this burner to develop yellow tips as the grill heats up.

### Turning off:

- Turn the control knob clockwise to the 0 position to turn off the burner.



Always make sure the control knob is in the 0 position when you have finished using the grill.

## Use of the oven

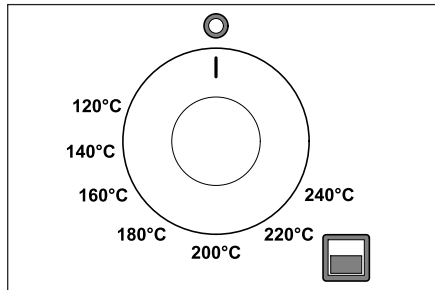

For the exact location of the control knob, see:

### Turning on:

- Open the door and push in the control knob.
- Continue pressing the knob and turn it anti-clockwise to the full rate position. (240°C/240°C, gas mark 7/9).
  - For spark ignition models: Push the ignition button.
  - For non-ignition models: Hold a lit match or gas match to the burner.
- Keep the control knob pressed for about 10-15 seconds and then release it.
- Adjust the required heat setting.
- Place the oven shelf in the required position and close the door.

Ignition must always be carried out with the oven door open.

If the burner accidentally extinguishes turn the control knob to the 0 position and wait at least 1 minute before re-igniting the burner.

If the burner was not lit within 15 seconds turn the control knob back to the 0 position and release it. Wait at least 1 minute and repeat the steps above to turn on the appliance.





Although the oven heats up quickly, a 10-minute preheat is recommended. The oven should reach full temperature in about 15-20 minutes.

## Turning off:

- Turn the control knob clockwise to the 0 position to turn off the burner.



Always make sure the control knob is in the 0 position when you have finished using the oven.

## Safe cooking

- Do not allow cooking vessels to overlap the edges of the appliance - use the correct sizes of pans and position them centrally over the burners.
- Ensure that there is at least a 10mm gap between the pans and the edges of the hob.
- Turn the pans so that the handles do not overhang the front of the appliance.
- Ensure that the flame of the gas burner heats the bottom of the pan, not the sides.
- The pans and trays supplied with this appliance are the maximum sizes. Do not use larger pans and trays. They may restrict good circulation of heat, which may increase cooking times.
- The oven shelf allows good circulation at the rear of the oven.
- A raised bar at the rear of the shelf prevents trays or dishes making contact with the back of the oven.
- To remove a shelf, pull it forward until it stops, raise at the front and remove.
- To place a shelf in the oven, lower it at the front and slide it backward until it stops.
- Do not leave the appliance unattended when in use.
- Do not use the appliance while the vehicle is moving.
- Turn the control knob back to the 0 position after cooking.
- Keep the appliance clean and prevent accumulation of grease and food scraps.

Never cover slots or holes in the appliance and never cover a shelf with materials such as aluminium foil. That restricts the airflow and may cause carbon monoxide poisoning.

The food shelves and trays in the appliance are hot during and after use. Allow all parts to cool before touching them, as this can cause serious injury. Always use oven gloves when removing the shelves and trays.



## Temperature control

The temperature in the oven is controlled by a thermostatic gas tap and is variable over the range 130°C to 240°C.

The table overleaf provides a guide to the approximate temperatures at each of the shelf positions with respect to the gas mark setting. Good use can be made of the temperature variation between the shelf positions, as several dishes requiring different temperatures may be cooked at the same time. In this way maximum benefit can be obtained from the gas used to heat the oven.



## Temperature zones

Gas Mark				Dish
1/4 - 1/2	90°C	110°C	130°C	Meringues
1	110°C	130°C	150°C	Stewed fruit
2	120°C	140°C	160°C	Rich fruit cake, rice pudding
3	130°C	150°C	170°C	Baked custard, shortbread finger
4	140°C	160°C	185°C	Victoria sponge
5	155°C	180°C	200°C	Whisked sponges, ginger nuts
6	170°C	190°C	215°C	Short crust pastry
7	185°C	210°C	230°C	Bread, scones, flaky pastry
8	200°C	220°C	245°C	Puff pastry
9	215°C	240°C	260°C	Quick browning



Care should be taken not to overload the oven, allow adequate spacing to ensure free circulation of heat.



When roasting with aluminium foil ensure the foil does not impair circulation of heat or block any oven flue outlet.

## Maintenance and cleaning

Thetford recommends an annual inspection service by an approved service centre. Between annual servicing, clean the appliance regularly after use. Before any cleaning work is started, the appliance should have been left to cool and be disconnected from the gas and electrical supplies.

- Always remove any spills or contamination immediately after use with soap and hot water. Towel dry the surface with a soft cloth.
- Use a non-abrasive multi-purpose cream cleaner and a nylon scourer pad to clean more stubborn dirt or grease.
- Use a proprietary stainless steel cleaner or polish to remove superficial surface scratching.
- Do not use abrasive cleaners, metal scouring pads or hard brushes. They could damage the appliance.
- If you clean the burner rings, ensure that the holes are not clogged.
- Do not use harsh abrasive cleaners or sharp metal scrapers to clean the glass surface, since they can scratch the glass surface which may result in shattering of the glass.
- Do not leave wet cloths, cleaning pads, residues of food or cleaning products or other dirt to dry on the surface. It can cause pitting, marking or even rusting.
- Always clean in the direction of the brushed finish and not across the grain.
- Cleaning agents containing bleach should not be left in contact with stainless steel.
- Mineral content in water (such as iron or lime scale) can affect the appearance of the metal.
- Remove any spillage from the glass lid before opening the lid.
- The control knobs can be removed for cleaning. The knobs are easy to replace.



## Refrigerator

### Operation

The refrigerator is equipped to operate on three power modes:

- **Mains voltage (230V AC)**
- **Direct-current voltage (12V DC)**
- **Gas (liquid gas propane/butane)**

Select the desired power mode by the **energy selector switch** (battery igniter type models) or the **energy selector button** (MES, AES). Appliances with automatic energy selection (AES) are additionally provided with "automatic mode" function. Then the AES system automatically selects the best energy source for each particular situation.

The cooling unit is silent in operation.

When the appliance is first put into operation, there may be a mild odour which will disappear after a few hours.

The refrigerator will take several hours to reach its operating temperature in the cooling compartment. The freezer compartment should be cold about one hour after switching on the refrigerator.

### Cleaning

Before starting up the refrigerator, it is recommended that you clean it inside and repeat this at regular intervals.

Use a soft cloth and lukewarm water with a mild detergent. Then wipe out the appliance with clean water and dry thoroughly.

To avoid material alterations, do not use soap or hard, abrasive or soda-based cleaning agents. Do not allow the door seal to come into contact with oil or grease.

## Maintenance

- In compliance with the applicable regulations, please note that the gas unit and the connected ventilation ducts must be checked by authorised technical personnel after first use and after every other year for compliance with the European Standard EN 1949. A test certificate has to be issued. **It is the user's responsibility to arrange this test.**
- The gas burner must be inspected and cleaned as necessary at least once a year. When using liquefied petroleum gas (tank or refill cylinders) the maintenance interval is reduced to half-yearly or quarterly. Keep the evidence of maintenance work carried out on your refrigerator.
- Work on gas and electrical equipment shall be carried out by qualified personnel only. It is recommended that this is carried out by an authorised customer care department.

We recommend maintenance following an extended shutdown of the vehicle. Please contact our customer care.

### Electrical operation

#### 12V-voltage (on-board power supply)

**CAUTION:** The refrigerator should only be used in 12V DC operation while the vehicle's engine is running, otherwise the on-board battery would be discharged within a few hours.

#### Mains power (230V)

**CAUTION:** This option should only be selected where the supply voltage of the connection for power supply corresponds to the value specified on the data plate. Any difference in values may result in damage to the appliance.



## Automatic energy selection/ automatic ignition on AES:

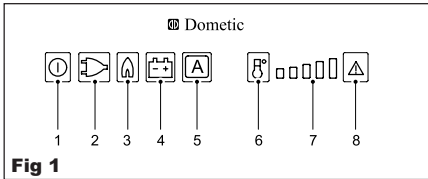

Fig 1

- 1 = Power ON/OFF switch
- 2 = Energy selector button      230V ~
- 3 = Energy selector button      GAS
- 4 = Energy selector button      12V =
- 5 = Selector button "AUTOMATIC"
- 6 = Temperature level selection
- 7 = Temperature level display
- 8 = Indicator LED failure / Reset button GAS FAILURE

### Switching ON/OFF

- Switch ON by pressing button (1), 2s
- Switch OFF by pressing button (1), > 2s

### Manual operation

- Select energy source with buttons (2, 3, 4)
- Set temperature step by pressing button (6)

### Automatic operation

- Change to "Automatic" with button (5)
- Automated energy selection (if available)  
Sequence of priority:    1) Solar (12V -)  
                                  2) 230V ~  
                                  3) 12V -  
                                  4) Liquid gas
- Set temperature step by pressing buttons (6).

## AES appliances (manual + automatic energy selection)

### Manual operation

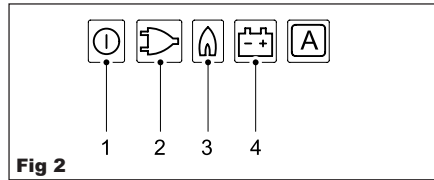

Fig 2

To start the refrigerator, press button (1) for 2 seconds.

The refrigerator starts with the last selected type of energy.

#### 230V operation:

Press button (2):



#### 12V operation:

Press button (4):



#### Gas operation:

Press button (3):



### Automatic operation

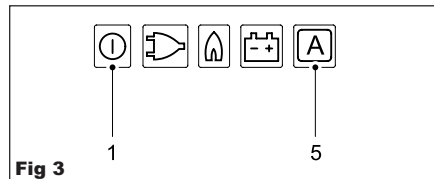

Fig 3

To start the refrigerator, press button (1) for 2 seconds.

The refrigerator starts with the last selected type of energy.

#### Automatic operation:

Press button (5): **A**

Upon switching on, the electronics automatically selects one of the three possible energy types: **230V - 12V - liquid gas**. The control electronics automatically ensures that the refrigerator is supplied with the optimum source of energy in each respective case.



- Sequence of priority:
- 1) Solar (12V -)
  - 2) 230V ~
  - 3) 12V -
  - 4) Liquid gas

If sufficient mains voltage is available (more than 195 V), this power source is selected as prime option. If a solar system capable of powering the refrigerator is installed, the solar 12V supply takes priority.

The 12V operation is otherwise only effective while the engine is running.

According to the sequence of priority the electronics selects GAS as energy source only, if both of the electrical energy source are not available.

Manual operation is possible at any time.

## Door locking

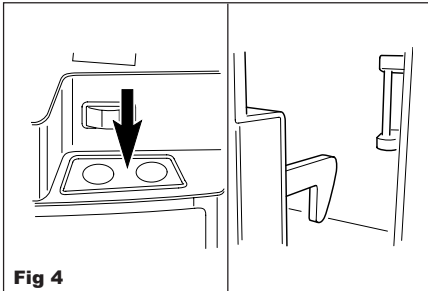

**CAUTION:** As a basic rule, shut and lock the refrigerator before you start your journey!

Open the door by pressing the locking button and pull open (Fig 4).

Shut the door again by pushing it to close. The snapping into the lock can be heard.

While the vehicle is parked, the locking hook may be fixed to facilitate opening of the door.

## Fastening and releasing the door lock when parking the vehicle

If the vehicle is parked for a longer period of time, the locking hook may be clamped by means of a lockbar. The door may now be opened by just pulling it without need of pressing the locking button.

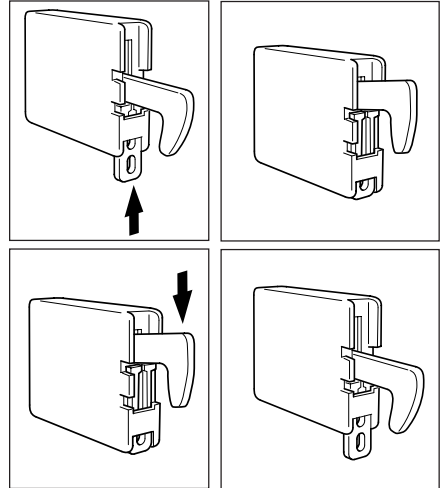

Fig 5



## RML10.4S (where fitted)

### Safety when operating

**CAUTION:** Failure to obey these cautions could result in minor or moderate injury.

### Health Hazard

- Make sure that you only put items in the device which may be chilled at the selected temperature.
- Opening the door for long periods can cause significant increase of the temperature in the compartments of the device.
- Food may only be stored in its original packaging or in suitable containers.
- Store raw meat and fish in suitable containers in the device, so that it is not in contact with or drip onto other food.
- If the device is left empty for long periods:
  - Switch off the device.
  - Defrost the device.
  - Clean and dry the device.
  - Leave the door open to prevent mould developing within the device.

### Risk of Injury

- The device door or the freezer door can completely detach from the device if used incorrectly. Push the doors closed until you hear a clear click at the top and bottom.
- Do not lean on the open device door.

### Damage Hazard

- If the door is not locked correctly on the opposite side, push on that side at the top and bottom until it locks in place.
- Only store heavy objects such as bottles or cans in the device door, in the vegetable compartment or on the bottom shelf.

### Intended Use

The device is suitable for:

- Installation in caravans and motorhomes.
- Cooling, deep-freezing and storing food.

The device is **not** suitable for:

- Storing medications
- Storing corrosive substances or substances that contain solvents
- Quick-freezing food

The refrigerator is an absorber refrigerator and is designed for operation

- on a DC power supply (12V)
- on an AC power supply
- with liquefied gas (propane or butane)

The refrigerator has an automatic operating mode that selects the most economical type of energy connected. The refrigerator unit operates silently.



## Operating and display elements

The LED display features the following operating and display elements

Symbol	Description
	ON/OFF button
	Fault indicator
	Operation with DC power
	Operation with gas
	Operation with AC power
<b>A</b>	Automatic mode
	Temperature indicator
	Energy selection button
	Temperature selection button

### Using the refrigerator

#### Note:

- Before starting your new refrigerator for the first time, clean it inside and outside with a damp cloth for hygiene reasons.
- When using the refrigerator for the first time, there may be a mild odour which will disappear after a few hours. Air out the living space well.
- Park the vehicle so that it is level, especially when starting up and filling the refrigerator before setting off on a journey.
- The cooling capacity can be affected by:
  - the ambient temperature (e.g. when the vehicle is exposed to direct sunlight)
  - the amount of food to be refrigerated
  - how often you open the door

#### Tips for optimal refrigerator operation

- Do not store goods in the refrigerator for the first 12 hours after start-up.
- Protect the interior of the vehicle from warming up excessively (e.g. sunshades in the windows, air conditioner).

- Protect the refrigerator from direct sunlight (e.g. sunshades in the windows).

### Operating the refrigerator

#### Controls

- Repeatedly press , until the LED indicates the desired operating mode.
- Repeatedly press until the desired temperature level is set.

#### Tank stop mode

**WARNING: Turn off the refrigerator or select a different operating mode if refuelling takes longer than 15 minutes.**

If the vehicle's ignition is switched off, the refrigerator will switch to tank stop mode for safety reasons. This blocks gas operation for 15 minutes. The refrigerator then automatically switches back to the standard automatic mode.

#### Setting the cooling capacity

**Note:** For ambient temperatures of +15°C to +25°C, select the average cooling capacity.

Set the cooling capacity:

Repeatedly press until the desired temperature level is selected.



## Troubleshooting

Fault	Possible cause	Suggested remedy
In AC power mode: The refrigerator does not work.	The fuse in the AC power supply is defective.	Replace the fuse.
	The vehicle is not connected to the AC power supply.	Connect the vehicle to the AC power supply.
	The AC heating element is defective.	Contact an authorised customer service point.
In DC power mode: The refrigerator does not work.	The fuse in the DC cable is defective.	The fuse on the relay must be replaced.  Contact an authorised customer service point.
	The vehicle fuse has blown.	Replace the vehicle fuse. (Please refer to the operating manual of your vehicle).
	The vehicle battery is discharged.	Test the battery and charge it.
	The ignition is not switched on.	Switch on the ignition.
	The DC heating element is defective.	Contact an authorised customer service point.
In gas mode: The refrigerator does not work.	The gas cylinder is empty.	Replace the gas cylinder.
	The gas valve is closed.	Turn the valve to open.
	Air is in the gas line.	Switch the refrigerator off and on again. Repeat the procedure three or four times if necessary.  If installed, switch on the stove and repeat the process on the refrigerator if necessary.
In automatic mode: The refrigerator is being operated with gas although it is connected to the AC power supply.	The grid voltage is too low.	The refrigerator automatically switches back to AC power supply as soon as the grid voltage is sufficient again.





## Troubleshooting

<b>Fault</b>	<b>Possible cause</b>	<b>Suggested remedy</b>
The refrigerator is not cooling adequately.	The ventilation around the cooling unit is not sufficient.	Check that the ventilation grille is not obstructed.
	The evaporator is iced up.	Check whether the refrigerator door closes properly. Make sure that the refrigerator seal fits correctly and is not damaged. Defrost the refrigerator.
	The temperature is set too high.	Set a lower temperature.
	The ambient temperature is too high.	Remove the ventilation grille for a while so that warm air can escape quicker.
	Too much food was placed in the refrigerator at the same time.	Remove some of the food.
	Too much warm food was placed in the refrigerator at the same time.	Remove the warm food and leave it to cool down before putting it in again.
	The refrigerator has not been operating for very long.	Check the temperature again after four or five hours.

## Fault messages and signal tones

All faults are indicated by a warning symbol, a fault ID and a beep. The beeping lasts for 2 minutes and is repeated every 30 minutes until the error has been rectified.

If multiple faults occur, the display shows the most recent fault. The underlying faults are displayed after the last fault has been confirmed.

In the event of a fault, the LED warning symbol () in the display lights up continuously and the LEDs flash according to the fault.



## Warning type fault messages

All faults of the WARNING type are reset automatically once the fault has been rectified.

	Fault	Solution
	Defective temperature sensor in the refrigerator compartment	Contact an authorised customer service point.
	AC power not connected or AC voltage <190V	Connect the refrigerator to AC power or select a different energy type, e.g. gas or DC power
	DC power not connected.	Connect the refrigerator to DC power or select a different energy type, e.g. gas or AC power.
	DC overvoltage (>16V)	Reduce the DC supply voltage.
	Tank stop mode: Gas operation is blocked for 15 minutes.	Wait 15 minutes or switch to another operating mode.
Beep	The door has been open for more than 2 minutes.	Close the door.

## Error type fault messages















All faults of the ERROR type must be reset manually:

Press for 2 seconds







✓ A beep sounds

✓ The error has been reset.



	<b>Fault</b>	<b>Solution</b>
	No connection between power module and display	Contact an authorised customer service point.
 	No cooling capacity in gas mode	Check if the device is at an angle and adjust it so it is level, if necessary.  Reset the error.  Contact customer service if this error occurs again.
 	No cooling capacity in AC power mode	Check if the device is at an angle and adjust it so it is level, if necessary.  Reset the error.  Contact customer service if this error occurs again.
 	No cooling capacity in DC power mode	Check if the device is at an angle and adjust it so it is level, if necessary.  Reset the error.  Contact customer service if this error occurs again.
 	Gas valve test error	Gas operation is not possible.  Reset the error.  Contact customer service if this error occurs again.
 	Internal communication error	Gas operation is not possible.  Reset the error.  Contact customer service if this error occurs again.
 	In stand-alone gas mode: The battery charge of the battery packs is too low	Insert new batteries and then reset the error.
	Gas lock after 3 ignition attempts	Ignition is not possible.  The gas cylinder is empty. Replace the gas cylinder.  Reset the error.



Fault		Solution
 	Gas lock, internal error in the power module.	Reset the error.  Contact customer service if this error occurs again.
 	Ground contact, gas valve	Reset the error.  Contact customer service if this error occurs again.
 	Ground contact, ignition electrode	Reset the error.  Contact customer service if this error occurs again.

## Cleaning and maintenance

**WARNING: Always disconnect the refrigerator from the energy supply before cleaning and servicing it.**

**Note:** When cleaning, never use sharp cleaning agents or hard or pointed tools to remove layers of ice or to loosen objects which have frozen in place.

- Clean the refrigerator regularly and when it gets dirty use a damp cloth.
- Make sure that no water drips into the seals. This can damage the electronics.
- Wipe the refrigerator dry with a cloth after cleaning.
- Check the condensate drain regularly. Clean the condensate drain when necessary. If it is blocked, the condensate collects on the bottom of the refrigerator.
- Make sure that the ventilation grilles in the outer wall of the motorhome and the refrigerator roof ventilator are free from dust and pollutants. This ensures that the heat generated during operation can dissipate, the refrigerator is not damaged and the cooling capacity is not reduced.

## Cleaning the gas burner

**WARNING:**

- Allow the burner to cool down before cleaning it.
- Do not modify the gas equipment.

**Note:**

- Dirt in the gas burner is indicated by poor ignition or deflagrations.
- The manufacturer also recommends cleaning the burner after it has not been used for an extended period and at least once a year.
- When using liquefied petroleum gas, the cleaning interval is reduced to half yearly or quarterly, depending on the level of dirt.

## Maintenance

**WARNING: Work on gas and electrical installations may only be performed by qualified technicians.**

- Have the gas system and connected flues inspected before starting up the device for the first time and by an authorised professional every two years to ensure they comply with the national safety requirements.
- Keep a record of any maintenance performed.



## ALDE HEATING (3020 Control Panel)

**CAUTION:** Do not drink any alcohol or take any drugs before or during operating the heating system and follow the safety instructions in this manual carefully.

### Turning the boiler on and off

The heating system is switched off.



The heating system is switched on.



1. To start the boiler, press the On/Off button and the start-up display appears. The boiler starts with the last selected settings. A green LED comes on beside the On/Off button when the panel/heating system is on.
2. To switch off the boiler, press the On/Off button.

### Standby

**Note:** If "Background light" is set to Dark, the display goes out when it enters standby mode, but lights up if you press the screen.

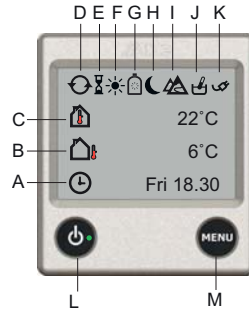

- A. **Clock** The clock shows the day and time (if activated).
- B. **\*Outdoor temperature**
- C. **Indoor temperature**
- D. **Circulation pump** The symbol is displayed when the pump is in operation.
- E. **Automatic start of the boiler** The symbol is displayed when the function is activated.
- F. **Day mode** The symbol is displayed when the function is on and turns green when activated.
- G. **\*LPG bottle full/empty** The symbol is displayed when the sensor on DuoControl is connected and activated. If EisEX is installed, a snowflake is shown inside the gas bottle.  
Green bottle = Bottle full  
Red bottle = Bottle empty
- H. **Night mode** The symbol is displayed when the function is on and turns green when activated.
- I. **High altitude mode** The symbol flashes if the high altitude mode is activated.
- J. The symbol flashes during heat up of \*Alde Flow when set in more hot water mode.
- K. **230 volt** The symbol is displayed when 230V is connected to the boiler.
- L. **On/Off button** Main switch for boiler.
- M. **MENU button** Button for settings menu.

Functions marked with a (\*) are accessories, which are not installed on all vehicles, refer to the vehicle manufacturer's instructions.



## Settings Menu

Launch the settings menu by pressing the MENU button. The background light comes on and those functions that can be set are displayed. Settings that you make are automatically saved after 10 seconds. The control panel will go to standby automatically after 30 seconds if the screen has not been touched.

The control panel in standby mode

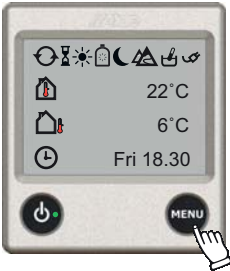

The control panel in settings menu

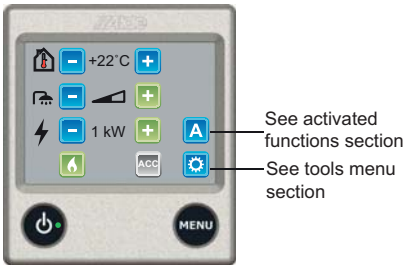

## Set the Desired Temperature

The temperature can be set between +5°C and +30°C, inclusive, in increments of 0.5°C.

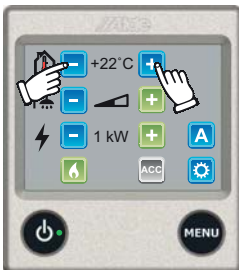

1. The temperature displayed is the temperature which is currently set.
2. Increase the temperature by pressing the "+" button. Reduce the temperature by pressing the "-" button.
3. The settings are now complete and the boiler will work at the set temperature.

**Note:** If night or day auto is activated and the time is within the scheduled period, a moon or a sun will appear beside the temp setting. The temperature set will be the one of the mode shown below:

- +22°C + [Moon icon] Night mode
- +22°C + [Sun icon] Day mode

## Domestic Hot Water

The boiler is fitted with a built-in hot water boiler which can hold approximately 8.5 litres. The boiler can equally well be used without there being any fresh water in the boiler. There are three different settings for hot water: no hot water, normal operation and more hot water.

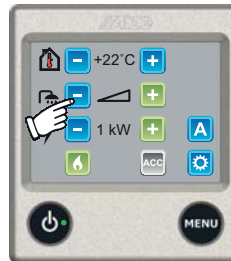

1. No hot water. If domestic hot water is not needed, press the "-" button (symbol becomes empty).

**Note:** If night, day or antimicrobial mode is activated and the time is within the scheduled period a moon, sun or the antimicrobial symbol will appear inside the hot water setting. The hot water setting will be the one of the mode shown below.

- [Empty symbol] + [Moon icon] Night mode
- [Empty symbol] + [Sun icon] Day mode
- [Antimicrobial symbol] + [Antimicrobial symbol] Antimicrobial mode



2. Normal operation. If there is freshwater in the heater and hot water is required, press the "+" button (the symbol will then show half-shaded).

**Note:** If the pump operation function has been set to Cont, this option cannot be selected.

**WARNING: Scalding Hazard: Since the hot water and the glycol heating fluid is heated simultaneously, the hot water can be very hot when a high level of heating is required.**



3. More hot water. If you need more hot water, the water temperature can be temporarily increased to around 70°C. Press the "+" button so that the symbol shows fully shaded (black). The boiler returns to normal operation after 30 minutes.

**Note:** If the pump operation function is set to Cont, then the continuous pump operation function is turned off for 30 minutes, before then returning to continuous pump operation.

**Note:** If an additional hot water tank is installed and the panel is in more hot water mode, the hot water function can then be in operation for longer than 30 minutes.

Info: When hot water only is required, during the summer for instance, or when there is no requirement for hot water, no settings need to be made; the boiler looks after this function automatically.

## Heating with Electricity

Proceed as follows to activate heating with electricity. The more power (wattage) you select, the quicker heating will take. A priority can be set when selecting both electricity and gas. The boiler uses no more power than is needed, even if it is set for 3kW.

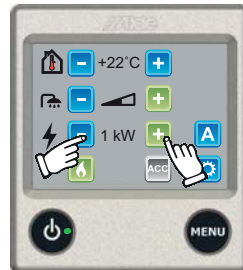

1. Use the + or - button to switch on the electric heating and toggle between the various power modes (Off, 1kW, 2kW or 3kW). The set value will be displayed on the screen. The activated mode is indicated by the + button changing colour to green. If a \*load monitor is installed and set, the boiler will not use more electricity than it is capable or even if 3kW is selected.
2. The settings are now complete and the boiler is working at the set temperature.
3. To switch off electrical operation, use the - button to toggle to Off.



## Heating with Gas

Proceed as follows to activate heating with gas. A priority can be set when selecting both electricity and gas.



1. Start gas operation by pressing the LPG flame symbol. The LPG symbol is activated and changes colour to green.
2. The settings are now complete and the boiler will work at the set temperature.
3. To switch off gas operation, press the LPG flame symbol. It will now change to blue.

## \*Fully Automatic Climate Control (ACC)

If a Truma AC is connected to the Alde, then the ACC button is visible and it is possible to control ACC from the panel. This function makes it possible to have fully automated climate control for both heating, cooling and hot water. The button is grey if not installed or if 230V is disconnected. With an outside temperature sensor fitted, ACC function is improved: operation of the AC is modified in line with the outdoor temperature.



Figure 1

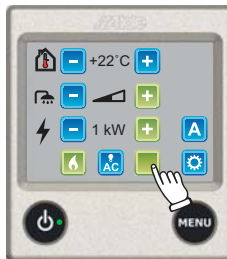

Figure 2



Figure 3

1. Set the desired temperature.
2. Press the blue ACC button, the button turns green (see fig. 2) and the ACC function is switched on, but is not necessarily in operation. If gas and/or electricity is switched on, AC and the boiler work to deliver the temperature set, regardless of whether heat or cooling is needed in the vehicle. To turn off the ACC function, press the ACC button and it becomes blue.
3. To turn AC lighting off and on, press the button rapidly. When the button is kept pressed in, the light changes from dark to light and then back (light to dark) and so on in 8 brightness levels. When the button is released it stays at the current brightness. This button is only visible when AC\* with in-built light is connected.

**NB:** Temperature sensors that are used when fully automatic climate control is in operation must be positioned so that they are influenced equally by the heat from the Alde heating system and the air from the AC. In certain cases it can be an advantage to use Alde's temperature sensor.





## Activated Functions A

Activated functions (See Figure 2) can be accessed by pressing the A symbol (see Figure 1). This screen shows the various functions that are activated. The respective function that is activated can be accessed from here and new settings can be made.

**Note:** The A symbol is only visible if one of the functions shown below is activated and/or installed.



Figure 1



Figure 2

Below is a description of the different symbols in the Activated Functions menu.

	Night mode is activated. However, it does not have to be within the time/day setting.		*Load monitor is connected and set to limited current.
	Automatic start of the boiler is activated. However, it does not have to be within the time setting.		*Booster is on.
	*This function is used if the heating system is to be operated via an external panel.		High altitude mode is activated.
	*Displayed if one or two external room sensors are connected.		*EisEx is installed but not necessarily turned on.
	Circulation pump in continuous operation.		*DuoControl or duoComfort is installed and connected to Alde Compact 3020 HE.
	Day mode is activated. However, it does not have to be within the time/day setting.		*Timer for engine heater is set but not necessarily within the set time/day.
	* The boiler is set to be started with External start but has not necessarily been activated.		*Underfloor heating is in operation.

Functions marked with a (\*) are accessories, which are not installed on all vehicles, refer to the vehicle manufacturer's instructions.



## Tools Menu

The tools menu can be accessed from the settings menu.

1. The control panel showing the settings menu. Press the tool symbol to access the tools menu.

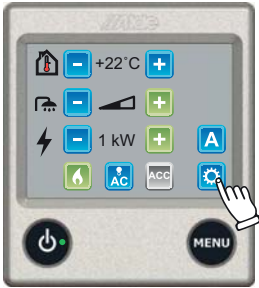



## Tools Menu - Functions

The following tools are available from the tools menu.

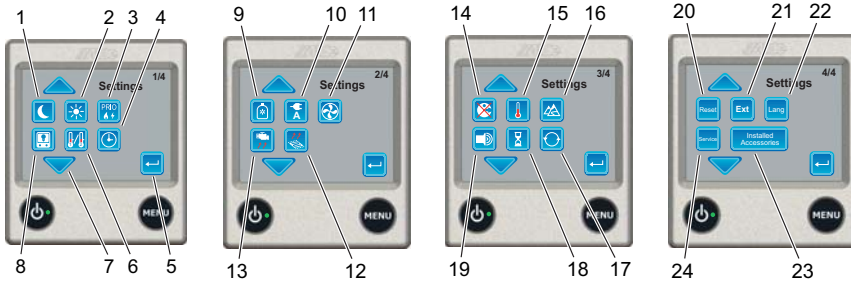
A grey function button means the function has not been installed and/or activated in "Installed Accessories".









	<p>1. <b>Night mode</b> Automatically changes certain functions during the night. You can select whether this is to take place every night or a specific night each week. The functions that can be changed are:</p> <ul style="list-style-type: none"> <li>• Temperature</li> <li>• *Change to temperature sensor in sleeping accommodation area</li> <li>• Invert display</li> <li>• Turn off the domestic hot water</li> <li>• *AC in quiet mode</li> </ul>		<p>2. <b>Day mode</b> Automatically changes certain functions during the day. Select that it takes place every night or a specific day each week. The functions that can be changed during the day are:</p> <ul style="list-style-type: none"> <li>• Temperature</li> <li>• Turn off the domestic hot water</li> </ul>
--	--	---	--

Functions marked with a (\*) are accessories, which are not installed on all vehicles, refer to the vehicle manufacturer's instructions.









# HOW TO USE YOUR MOTORHOME'S EQUIPMENT









	<p>3. Pro setting With this function you can choose to prioritise (select) electricity or gas as the main alternative.</p>		<p>4. Clock The clock must be set if engine heater start, night and/or day auto and automatic start are to work.  If 12V power is lost, the clock will stop and will no longer be displayed. Installing "battery backup" will prevent this happening.</p>
	<p>5. Return To return to the previous menu, press this symbol.</p>		<p>6. *Setting room sensor Select which temperature sensor is to be active. Here you can select whether the sensor located in the daytime living area, the sleeping accommodation or in the panel is to be active. If Auto is selected, the sensor in the panel is active and will automatically switch to a room sensor (sofa and/or bed) if one of these is connected. If two room sensors are connected, it will be the one for the daytime living area that is active (sofa).</p>
	<p>7. Arrow symbols Toggle between the various tool fields by using the up/down arrow symbols. Leave the tools menu using the MENU button or the return button.</p>		<p>8. Background light The background light can be set in three different modes, Dark, Bright and Invert.  <b>Dark:</b> Turns off background light. Press the screen or the menu button when standby is activated and the screen comes on, but returns to dark after 30 seconds if the panel is not touched.  <b>Bright:</b> Background light in standby mode.  <b>Invert:</b> Inverted background light in standby mode.  Standby is activated automatically after 30 seconds if the panel is not touched.</p>

Functions marked with a (\*) are accessories, which are not installed on all vehicles, refer to the vehicle manufacturer's instructions.



	<p>9. *EisEX, 12V defroster for gas regulator. This is a small heating element that prevents ice forming in the regulator in winter (for Mono Control CS, DuoControl CS, DuoControl and DuoComfort). If DuoControl CS or DuoControl is installed and connected, a snowflake will appear inside the gas bottle symbol when EisEX is switched on.'</p>		<p>10. *Load monitor The function prevents overload of the fuses on 230V. If the total current consumption of the vehicle exceeds the set value, the electrical output of the boiler will be reduced automatically. This also applies to Truma Comfort AC if connected to the Alde 3020. Due to voltage fluctuations and tolerances, different regulation levels can be selected (5-17A). If the fuse blows repeatedly, choose a lower setting.  NB. For ACC to function with the load monitor, ACC must be on from the panel and not via the remote control.</p>
	<p>11. *Booster Control of booster in two different speeds. Fan start and stop is controlled from the boiler. If the boiler's circulation pump starts up, the fan on the booster will as well. When the circulation pump stops, the fan will continue to run for another six minutes. It will then stop unless the circulation pump has started up again.</p>		<p>12. *Under floor heating The function governs the under floor heating pump's operation in intervals, which means that the under floor heating pump is in operation for 5 min and is then off for 5 min when heat is required.  <b>Mode:</b> Make sure Delay or Cont. is activated; in these two modes, under floor heating is switched on. In Off mode under floor heating is off. NB. In Cont. mode it can get hotter in the vehicle than desired, as the heat control is disabled!  <b>Delay:</b> The under floor heating pump is on for a certain period after the boiler's circulation pump has stopped, this Delay can be set at 15 min, 30 min or 120 min.</p>
			<p>14. Antimicrobial mode The boiler will start at 02.00 in the morning (if the clock is set) and run as indicated for "More hot water" for 30 minutes. This is to reduce the risk of legionella.</p>



	<p>15. Offset (temperature adjustment) If the temperature that is displayed in the panel does not correspond to the actual temperature, it can be adjusted by <math>\pm 5^{\circ}\text{C}</math> in the panel. Applies also to display of external temperature.</p>		<p>16. High altitude mode The function should only be used if the boiler will be powered by LPG at a height above 1000 m above sea level. NB. For LPG operation at high altitude, use propane to obtain stable combustion. NB. Variations in operating conditions at high altitudes can mean that the boiler always achieves stage 1 output, but not always stage 2 on LPG operation.</p>
	<p>17. Circulation pump settings Cont. This function limits the supply of hot water, particularly when there is a low heating requirement. Therm: The pump is controlled by the room sensor. This is the normal mode for heat and hot water.</p>		<p>18. Automatic boiler start Starting the boiler at a certain time/on a certain day. The boiler will be on every week during the time set, until the function deactivated. For automatic start to function, the boiler must be turned off.</p>
	<p>19. Sound Audible signals in various situations:</p> <ul style="list-style-type: none"> <li>• Turn the button sound on and off.</li> <li>• Audible signal on reaching hot water temperature when Alde Flow* is installed and more hot water is selected.</li> <li>• Audible signal on "Gas Failure".</li> <li>• Audible signal on LPG bottle change if a duoControl* is installed and activated in "Installed Accessories".</li> </ul>		<p>20. Reset Pressing Reset resets the panel to its factory settings. NB. Settings made in installed functions are not deleted</p>
	<p>21. External start The function is used when starting the boiler from outside. When external start has been activated the panel must be turned off, but 12V should be connected. The parameters/functions that the boiler is to have when it starts must be set before turning off the control panel. NB. Using this function requires installation of an accessory that can use external start.</p>		

Functions marked with a (\*) are accessories, which are not installed on all vehicles, refer to the vehicle manufacturer's instructions.



	<p>21. (continued from over)</p> <p><b>230V.</b> The function is used to start the boiler by connecting 230V to the vehicle. When the 230V function has been activated the control panel must be turned off, but 12V should be connected. The parameters/functions that the boiler is to have when it starts must be set before turning off the control panel (230V connected). Certain vehicles can be equipped with an individual solution (*winter connection).</p>	<p>Lang</p>	<p>22. Language</p> <p>Switch between different languages. Available languages are English, French and German. However, the service menu is only available in English.</p>
<p>Installed Accessories</p>	<p>23. Installed functions</p> <p>The accessories that are installed are activated here.</p>	<p>Service</p>	<p>24. Service menu</p> <p>This contains the following, amongst others:</p> <ul style="list-style-type: none"> <li>Glycol temperature</li> <li>Domestic hot water temperature</li> <li>12V power to the boiler</li> </ul>
<p><b>To exit the tools menu, press Return or Menu.</b></p>			

## Service Menu

The service menu is accessed by pressing Service (see Fig. 1). The function shows the values from the boiler on the screen (Fig 2 to 4). The values are updated every second.

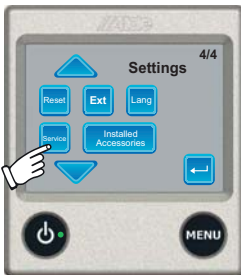

Figure 1



Figure 2

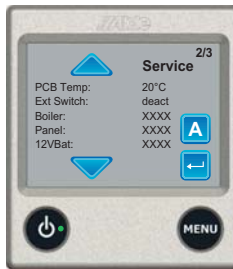

Figure 3

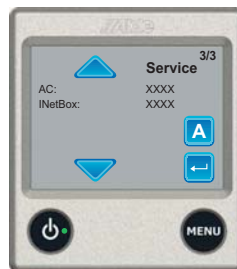
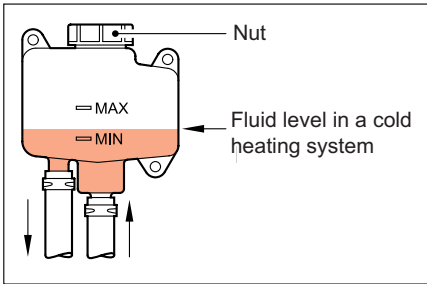

Figure 4



## Fluid level of heating system



**CAUTION:** The heating system comes installed with glycol heating fluid. If the fluid level is too low you must fill the system to the right level before operating the heating system.

Your warranty may be voided and the heating system may be damaged if you attempt to start it with little or no glycol heating fluid.

**Note:** Do not mix different types of glycol; this can lead to coagulation of the glycol fluid.

**Note:** Omitting to change the fluid can result in frost damage, corrosion, bacterial growth and/or overheating.

**Note:** The Alde Premium Antifreeze should be changed at intervals of 5 years when under normal operating conditions.

For further information about your Alde system, please refer to Alde Handbook.



## Water System - Diagnostics

To aid with trouble shooting the green LED on the Intelligent Control® unit will flash to indicate different fault types.

LED	Code
<b>On</b>	Tap open and pump running
<b>Fast Flash</b> (flash every 1 second or less)	In Calibration Mode
<b>5 Second Flash</b> (flash every 5 seconds)	Calibrated and ready for use Normal operation
<b>10 Second Flash</b> (flash every 10 seconds)	Un-calibrated. Follow calibration instructions
<b>15 Second Flash</b> (flash every 15 seconds)	Water container is empty. Turn Master Switch 'off' then 'on' again
<b>20 Second Flash</b> (flash every 20 seconds)	Battery voltage is low. Turn Master Switch 'off' then 'on' again and charge battery

## Water System - Troubleshooting

Problem	Solution
Pump will not run	Check at least one tap is open
	Turn the pump isolator switch 'off' then 'on' again
	Check the battery is fully charged
	Check the pump isolator switch is 'on'
	Check the master switch is 'on'
	Clean the electric contact strips on either side of the plug and ensure they are making contact with the socket
	Check wiring connections
Pump cycles on and off with all taps and showers are closed	Check fuse (see fuse box)
	Check for air or water leaks in taps and piping
	Check the non-return valve (fitted in the socket) is free from grit and dirt. Use a ballpoint pen to dislodge any grit in the non-return valve
Pump runs for 30 seconds or more without stopping when all taps and showers are closed	Recalibrate the system - follow calibration instructions
	Check all connections in the pipework are secure
	Recalibrate the system - follow calibration instructions.





## Water System - Maintenance

Whale Watermaster Pump with Intelligent Control® is designed to be maintenance free and does not contain any serviceable parts. Please note: The Intelligent Control unit is enclosed to protect the electronics and must not be opened. Opening the unit will result in damage and may invalidate your warranty.

Whale recommends a regular schedule of inspection, at least twice a season.

## Water System - Replacement Parts

Part Number	Description
GP1652	Whale High Flow Pump Only
EP1612	Whale High Flow Pump and Plug
EP1612	Whale Watermaster IC® Kit - includes High Flow Pump and Plug and IC Unit

## Water System - Winterising

Your water system must be drained fully when not in use. For details of how to drain your water system in preparation for winter storage please see our guide at the back of the handbook.

## Water System - Support

For installation advice or help with your water system please contact Whale Support.

Tel: +44 (0)28 9127 0531

E-mail: [info@whalepumps.com](mailto:info@whalepumps.com)



## MICROWAVE

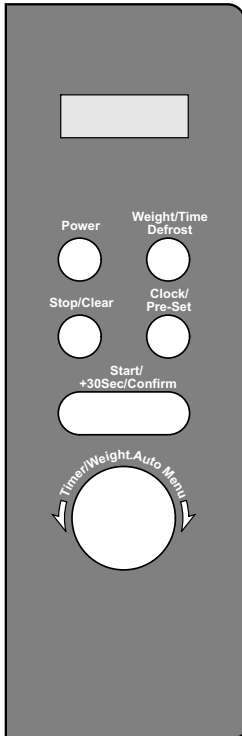

**MENU ACTION SCREEN** Cooking time, power, auto and the clock time are displayed.

**POWER** Press to select the power level for microwave cooking.

**WEIGHT/TIME DEFROST** Press this button to input weight for defrosting.

**CLOCK/PRE-SET** Press this button to input weight for defrosting.

**STOP/CLEAR** Press to stop the cooking process.

**TIMER/WEIGHT . AUTO MENU** Rotate to select the cooking time and the auto menus.

**START/+30SEC/CONFIRM** Press this button to start the cooking process and confirm when programming.

**DOOR OPEN** Pull the handle to open the door.

## Microwave cooking

- 1 Press the "POWER" button once and "P100" will display and flash.
- 2 Turn the "TIMER/WEIGHT" to select the microwave power. "P100", "P90", "P80", "P70", "P60", "P50", "P40", "P30", "P20", "P10" and "P00" will display in order.
- 3 Press "START/+30 SEC" to confirm.
- 4 Turn the "TIMER/WEIGHT" dial to adjust the cooking time. (The time setting should be between 0:05-95:00).
- 5 Press "START/+30 SEC" to start the cooking process.

Press power button	Cooking power
P100	100%
P90	90%
P80	80%
P70	70%
P60	60%
P50	50%
P40	40%
P30	30%
P20	20%
P10	10%
P00	0%

To stop the cooking process at any time press the "STOP/CLEAR" button.

For further appliance information please refer to microwave user manual.

## Battery Charger

The battery charger for the leisure battery will automatically switch on when the motorhome is connected to a mains supply. The battery charger will also provide a 12V supply to the vehicle when a battery is not connected. Please note that the battery charger fitted is designed to keep your battery charged and is not designed for charging up a flat battery.



## SMOKE ALARM

### Operation

#### Normal Condition

The red LED on the front should flash every 40 seconds to show that the alarm is active.

#### Lower Power Pack Condition

**IMPORTANT:** Your smoke alarm requires the power pack to have sufficient capacity of power to operate correctly.

Should your smoke alarm enter a low power pack condition, the unit will emit an audible 'chirp' once every 40 seconds. When this occurs, we recommend you replace the alarm immediately. Your smoke alarm will continue to warn of this low power pack for at least 7 days, however, failure to change the alarm after this time would mean your smoke alarm may have insufficient power to alert you in a real fire situation. When the alarm is removed from the base plate the power pack will automatically deactivate and the low power warning chirp should stop, allowing you to dispose of the alarm.

#### Low Battery Warning Silence

This feature can temporarily silence the low battery chirp for 8 hours which is particularly useful if the warning begins during the night. This feature may be repeated up to 10 times, but is not a substitute for replacing the smoke alarm.

#### Alarm Test

The alarm must be properly attached to the base plate before it can be tested.

- Press the test button in the centre and release.

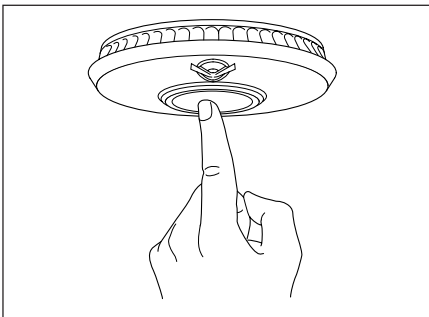

- The unit will give an audible alarm consisting of 2 cycles of 3 loud beeps, then stop automatically.

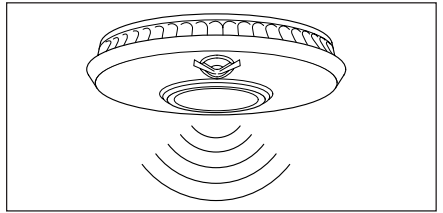

- The red LED on your alarm will flash rapidly during the audible signal.

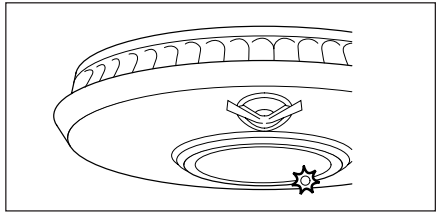

**Note:** The test button accurately tests the alarm's smoke sensing circuit, there is no need to test your alarm with smoke. If your smoke alarm fails to give an audible test signal, please refer immediately to the trouble shooting guide at the end of this manual.

**WARNING: You should test your smoke alarm every week.**



## ALARM SMART SILENCE™

**DANGER:** If your smoke alarm emits the full alarm signal and you are not testing the unit, the smoke alarm is warning you of a potentially dangerous situation that requires your immediate attention. Only use the alarm silence function after making sure that there is no ongoing fire emergency situation. Do not block the vents on the alarm or disable the smoke alarm in any way, as this will remove your protection. Smoke alarms can sometimes react to cooking fumes or other non emergency situations. Your smoke alarm features "Smart Silence" technology. In the event of a known false alarm your smoke alarm can be temporarily silenced by pressing the central test button. Your alarm will automatically return to full sensitivity within 10 minutes.

**Note:** If the level of smoke reaching the alarm is very high, the alarm silence will be overridden and the alarm will continue to sound.

- Press and release the silence button, the alarm sound will shortly stop.

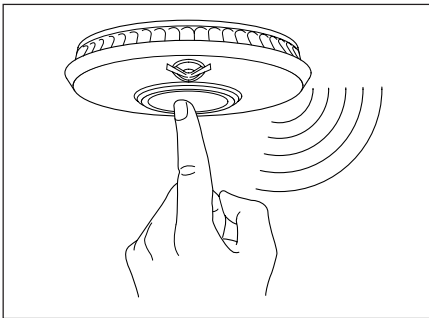

- Your alarm will silence and enter into a reduced sensitivity reset cycle for approximately 10 minutes.

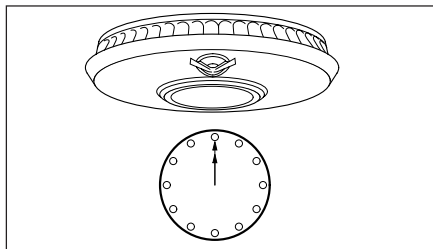

- During the reduced sensitivity reset cycle, the red LED on your alarm will continue to flash more rapidly than normal, approximately once every second.

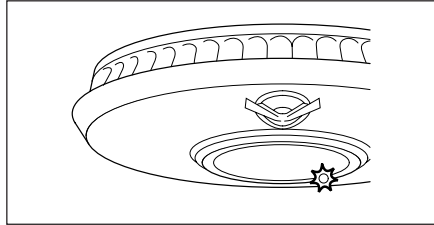

- Your alarm will automatically return to full sensitivity on completion of the reset cycle and the red LED will revert to flashing once every 40 seconds.

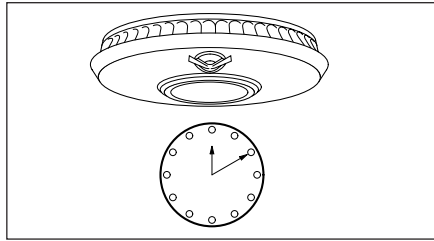

**DANGER:** Never ignore any alarm. Ignoring the alarm may result in injury or death. If your smoke alarm activates and alarms and you are not absolutely certain of the source of the smoke, get everyone out of the caravan immediately.

## LOW BATTERY WARNING SILENCE

Low battery warnings often start at night or when it maybe inconvenient to replace your alarm. You can silence the audible chirp for a period of 8 hours by pressing the test button. Your smoke alarm will still detect smoke during this time of low battery warning silence. However, it is recommended that you replace your alarm immediately and certainly within 7 days, as your alarm may then have insufficient power to warn you of a real fire situation after this time.

**WARNING:** Your smoke alarm cannot be silenced if the chirp is indicating a fault. In this instance, the unit should be replaced immediately to ensure protection in the event of a fire.



## MAINTENANCE

Your smoke alarm has been designed to be as maintenance-free as possible, however there are several things you must do to keep it working properly.

**CAUTION:** Your smoke alarm is a sealed electrical device and no attempt should be made to open the case. Attempting to open the case will invalidate your warranty.

### Testing

Test your smoke alarm once every week see 'Alarm Test'. Any test failures should be reported to the Technical Support Team.

### Cleaning

As a minimum your smoke alarm should be cleaned once every 3 months using your vacuum cleaner fitted with the soft brush attachment.

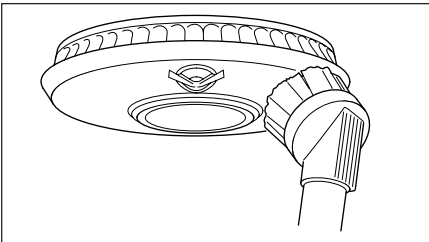

**WARNING:** Your smoke alarm may false alarm when it is being cleaned using a vacuum cleaner.

**IMPORTANT:** Do not use solvents or cleaners on your smoke alarm, as they may cause damage to the sensor or circuitry. The unit can be wiped with a slightly damp cloth.

**CAUTION:** Do not paint the smoke alarm as this may block the openings and prevent smoke from entering the sensor.

## CARBON MONOXIDE ALARM

### Carbon monoxide and how it can affect you and your family

Carbon monoxide is a dangerous poisonous gas that kills hundreds of people each year and injures many more. It is often referred to as the silent killer because it has no odour or taste and cannot be seen. Like oxygen, CO enters the body through the lungs during the normal breathing process. It competes with oxygen by replacing it in the red blood cells, thereby reducing the flow of oxygen to the heart, brain and other vital organs. In high concentrations, CO can kill in minutes.

Many cases of reported carbon monoxide poisoning indicate that while victims are aware they are not feeling well, they become disorientated and unable to save themselves by either exiting the building or calling for assistance. Exposure during sleep is particularly dangerous because the victim does not wake up.

### Symptoms of CO poisoning

The following symptoms may be related to CO poisoning which all household members should be made aware of:

- Mild Exposure: Slight headache, nausea, vomiting, fatigue (often described as 'flu-like' symptoms).
- Medium Exposure: Severe throbbing headache, drowsiness, confusion, fast heart rate.
- Extreme Exposure: Unconsciousness, convulsions, cardiorespiratory failure, death.

Your CO detector monitors the level of CO as parts per million (ppm) in the atmosphere surrounding the detector.

- 35ppm The maximum allowable concentration for continuous exposure for healthy adults in any 8 hour period, as recommended by the Occupational Safety and Health Administration (OSHA).
- 200ppm Slight headache, fatigue, dizziness, nausea after 2-3 hours.
- 400ppm Frontal headaches within 1-2 hours, life threatening after 3 hours.



800ppm Dizziness, nausea and convulsions within 45 minutes.  
Unconsciousness within 2 hours.  
Death within 2-3 hours.

Should you suspect CO may be affecting you or your family, open the doors and windows of your caravan to ventilate, turn off your appliances and evacuate the premises. At this time the authorities should be contacted to locate the source of the carbon monoxide before re-entering the caravan. Medical attention should be sought for anyone suffering the effects of CO poisoning.

### Common sources of CO

- Oil and gas boilers
- Portable generators
- Oil or solid fuel cookers
- Barbecues
- Clogged chimneys
- Wood or gas fireplaces
- Cigarette smoke
- Gas appliances
- Any fossil fuel-burning appliance

**WARNING: This carbon monoxide detector is not a combustible gas detector, nor a smoke detector. Please install the proper detectors to detect combustible gases, or smoke.**

This CO detector should not be seen as a substitute for the proper installation, use and maintenance of fuel-burning appliances (including appropriate ventilation and exhaust systems), nor the sweeping of chimneys.

**WARNING: Variables relating to your fuel-burning appliances can change at any point eg. the flue or chimney could suddenly become blocked or damaged, appliances may stop running correctly or circumstances in neighbouring properties may change resulting in the presence of carbon monoxide. For this and other reasons do not use this carbon monoxide detector on an intermittent basis, or as a portable detector or an intermittent basis, or as a portable detector for trying to trace one source of the spillage of combustion products from fuel-burning appliances or from chimneys.**

### Do not:

- IGNORE ANY WARNING FROM YOUR CO DETECTOR!
- Burn charcoal inside your home, caravan, tent or cabin.
- Install, convert or service fuel-burning appliances without proper knowledge, skill and expertise.
- Use a gas cooker for heating a room.
- Operate unvented gas burning appliances using paraffin or natural gas in closed rooms.
- Operate petrol-powered engines indoors or in confined areas.
- Barbecue indoors, or in an attached garage.
- Ignore a safety device when it shuts an appliance off.

### Always:

- Buy appliances accepted by a recognised testing laboratory.
- Install appliances according to the manufacturer's instructions.
- Have appliance installations carried out by professionals (for gas appliances engineers should be registered on the Gas Safe register).
- Have your appliances checked regularly by a qualified service engineer.
- Have your chimneys and flues cleaned professionally every year.
- Make regular visual inspections of all fuel-burning appliances.
- Open windows when a fireplace or oil/solid fuel cooker is in use.
- Only install CO detectors that meet the requirements of EN 50291-1: 2010 and EN 50291-2: 2010 in your home.
- Be aware of CO poisoning symptoms.
- Educate yourself and your family on the sources and symptoms of CO poisoning and how to use your carbon monoxide detector.



## Operating Features

Your detector offers many features which set it apart from other CO detectors on the market today.

### Test/Reset button feature

- Test the sounder, batteries and circuitry.
- Allows you to test the sensor by introducing a source of CO into the detector (see 'Testing the Sensor').
- Silence the loud 85dB sounder during an alarm (only possible when current CO level is less than 50ppm).

### Testing the sounder, batteries and circuitry

Test the sounder, batteries and circuitry by pressing and holding the Test/Reset button for 1 second to confirm that the detector is operating properly. The sounder should sound as soon as the button is pressed and the Alarm LED will illuminate red, indicating that the sounder is working and the batteries are providing power to the unit. This test for the sounder, batteries and circuitry should be performed weekly.

### Testing the sensor

**CAUTION:** Sensor testing should only be performed by a responsible adult. This test should only be performed once a year. Excessive testing will cause the life of the alarm to be shortened.

**Note:** Aerosol CO may be used in order to avoid having to burn incense sticks.

Read all steps thoroughly before attempting to test the sensor.

**Step 1** If the detector is wall or ceiling mounted unhook the detector from the screws.

### Step 2

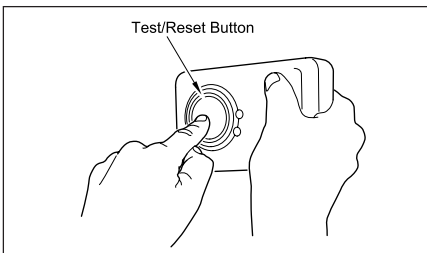

Cover the sounder vents with one hand. Press and hold the Test/Reset button down with your thumb/finger until the Power LED illuminates green and the sounder sounds for a second time (this should happen after around 5 seconds). Release the Test/Reset button. Upon releasing the Test/Reset button the Power LED will flash green once every second. This indicates that the sampling rate of the detector has increased and can be tested using a known source of CO.

**Step 3** Light an incense stick using a match or lighter. Be sure to blow out the flame so that the incense stick is smouldering. Extinguish the lighter, or put out the match and place it into a dish of water.

### Step 4

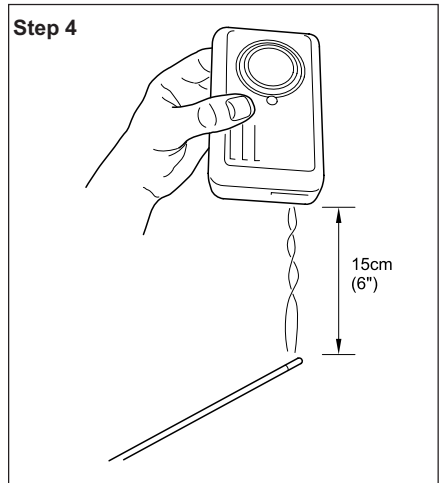

Turn the detector on its side so that the vents on the right hand side of the detector are pointing downwards. Hold the burning incense stick around 15cm (6 inches) below the detector, so that the smoke enters the vents on the side of the detector. An increase in the localised carbon monoxide level within the sensor to more than 50ppm will cause the sounder to sound for one cycle of



four loud beeps and the Power LED to illuminate green for a short time. This is the end of the test. The Power LED will no longer flash green every second but will revert to flashing once every minute as the detector will go back to normal operating mode (it may take up to two minutes of exposure to the smoke for the localised level of carbon monoxide within the sensor to reach over 50ppm). Now move the source of CO away from the detector as the test is finished.

**Step 5** After step 4, put out the incense stick by placing it into a dish of water. Ensure that all flames have been extinguished.

**Note:** If the localised carbon monoxide level within the sensor does not reach 50ppm during the test, the sensor test will stop automatically after 3 minutes.

### Understanding the products indicators

The higher the concentration of carbon monoxide detected by the detector, the quicker it will respond. When sufficient carbon monoxide is detected a loud audible signal (85 dB at 1m/3 feet) will be emitted and the Alarm LED will flash red once every second.

### The alarm will sound:

- Between 60 and 90 minutes when exposed to 50ppm of CO.
- Between 10 and 40 minutes when exposed to 100ppm of CO.
- Within 3 minutes when exposed to 300ppm or more of CO.

### Fault/End of Life signal:

The unit continuously checks the settings of its sensor and circuitry. If any of these settings are found to be incorrect or if the batteries become low then the detector will emit a single audible chirp once per minute for up to 30 days. **IMPORTANT:** This does NOT mean that the detector has detected carbon dioxide.

Replace batteries immediately. If the product continues to chirp despite having new

batteries and the product is still within warranty then contact Technical Support for advice. If the product is no longer in warranty replace it immediately.

### Maintaining/testing your detector

Your detector will alert you to potentially hazardous CO concentrations in your home when maintained properly. To maintain your detector in proper working order and to ensure that the sensor will last for the lifetime of the product, it is recommended that you:

- Test the sounder, batteries and circuitry of your detector once per week by pressing and holding the Test/Reset button for 1 second.
- Perform the sensor test annually.
- Keep the detector free of dust by gently vacuuming the case with a soft brush attachment every 3 months.

To prevent the possibility of contaminating the sensor in your detector and thus affecting its reliability:

- Never use cleaning solutions on your detector. Simply wipe with a slightly damp cloth.
- Do not paint the detector.
- Do not spray aerosols on or near the detector.
- Do not use any solvent based products near the detector.
- If installing in a caravan or boat there may be other substances present that may not normally be found in the home that could affect the reliability of the CO alarm. Avoid using the following in close proximity to the alarm; oils, cleaning fluids, polishes, paints and greases.
- Do not attempt to repair your CO detector. Do not remove any screws or open the main casing of your detector. Any attempt to do so may cause malfunction and will invalidate the warranty.





## ROOFLIGHTS

Your motorhome is fitted with at least one type of the following roof lights:

### The Heki 2

#### To Open To The Tilted Position:

- (i) Press the knob in the toggle catches on either side of the rooflight and turn through approx. 90°.
- (ii) Grasp the metal bar in the middle, snap it out of its holder, swivel down and press the rooflight upwards. (The rooflight is held by the two gas springs after approx. 150mm).
- (iii) Swivel the metal bar towards the rooflight and snap into its holder.
- (iv) To close the rooflight, proceed with steps (i to iii) in reverse order.

#### To Open In The Intermediate Position:

- (i) Open the toggle catches on either side of the rooflight.
- (ii) Grasp the metal bar in the middle; snap it out of its holder, swivel down and press the rooflight outwards. Rooflight is opened automatically after approx. 150mm by the two gas springs).
- (iii) Open both fasteners and swivel the metal strap towards the intermediate position and pull the rooflight down until the metal strap is stopped by the fasteners.
- (iv) To close, proceed with steps (i to iii) in reverse order.

#### To Open In The Ventilation Position:

- (i) Open the toggle catches on either side of the rooflight.
- (ii) Using both hands on the two toggle catches, press the rooflight up about 2cm and fasten the toggle catches in the corresponding setting.
- (iii) To close, proceed with steps (i-ii) in reverse order.

#### Closing The Blinds:

- (i) Take hold of the end rod (without rocker) in the recessed grip and engage in the opposite end rod (with rocker).

- (ii) Select the required position (blackout/ flyscreen) by moving both joined end rods together.

**CAUTION:** In extremely bright sunshine, the blackout blind must only be closed two-thirds, and the rooflight must be set in the continuous airing position.

#### Opening The Blinds:

- (i) Move blind (end rod with rocker) right to the outside.
- (ii) Hold the recessed grip with one hand; with the other hand, press the rocker and move the blind back (do not let it recoil).

#### CAUTIONS:

- Do not stand on the acrylic rooflight.
- Close HEKI 2 completely before moving off.
- Do not leave your Motorhome when HEKI 2 is open.
- Please consult your supplying dealer if you have any problems or defects.
- Remove any snow/ice or dirt before opening the roof.
- Do not open when it rains or when there is a strong wind.



## The Omnivent (12v) Rooflight

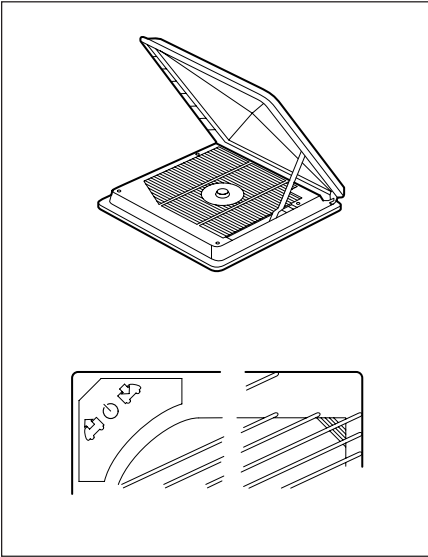

The Omnivent is a double-glazed roof light constructed from a synthetic ultra-violet screened material. Its side-operating mechanism allows a completely free central opening with built-in fixed ventilation when closed. It operates as an extractor fan and air intake fan.

**Please note:** Do not change the direction of the fan unless it has been switched off 'O' position and the blades have stopped rotating.

### Door Flyscreen

The exterior door flyscreen can be opened or closed from both inside and outside of the Motorhome and does not restrict door openings.

When opening or closing the door flyscreen use the finger grip provided.

## Windows

Your new Motorhome will be fitted with Polyplastic opening windows.

### Polyplastic Window Opening

- (i) In order to open the Polyplastic window it is only necessary to move the catch upwards and release the catch from the backing plate.
- (ii) The Polyplastic window should remain in the open position once opened, however if it does not then tighten the friction control on the window stays to increase the holding force.
- (iii) The Polyplastic window is also fitted with a night ventilation position where the catch is set to the centre position on the backing plate; in this position it may be possible for rain to enter the motorhome in adverse conditions.

## TAPS

### Kitchen Taps

Your new motorhome will be fitted with a mixer tap.

**CAUTION:** The water temperature could be very high so do not lift the lever with the tap turned to the full left position. For winter storage and to prevent frost damage the tap swivel must be left in the centre up position.

### Washroom Taps And Showers

Your motorhome will be supplied with either a vanity mixer tap or separate shower mixer, or with a combined mixer tap with retractable shower head.

### Note:

- The water temperature could be very high so do not lift the lever with the tap turned to the full left position.
- For winter storage and to prevent frost damage the tap swivel must be left in the centre up position.



## INTERNAL DOORS

### Toilet / Washroom Doors

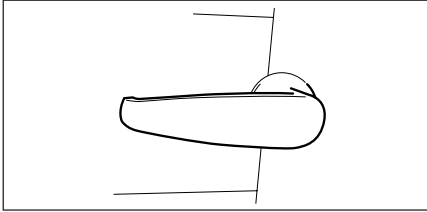

Toilet / washroom doors are fitted with a lever lock, which is operated by pushing the lever down. The lever is spring-loaded and will return to the closed position upon release. It is recommended that the lever is always used when closing the door.

The door can be locked from the inside by pushing the small lever downwards. To unlock just push the small lever up. The door can be unlocked from the outside by using a flat head screwdriver on the turnbuckle.

#### Inside the bathroom

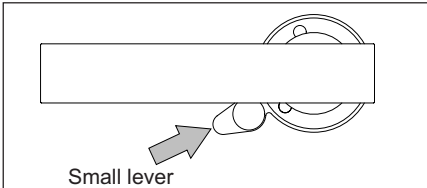

Small lever

#### Outside the bathroom

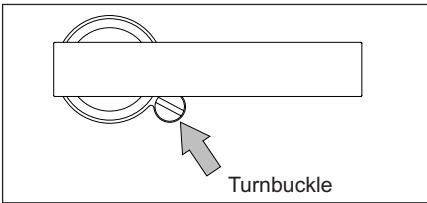

Turnbuckle

### Other Internal Doors

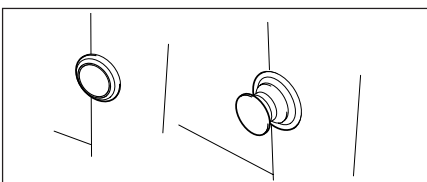

Other internal doors such as the wardrobe and table storage locker are fitted with a 2-position button lock. Push the button to lock the door and the button should remain flush with the door. Push the button again to release and the button should then protrude from the door surface.

### Magnetic Catches

Magnetic catches work on contact with the metal plate on the rear of the door. Simply close the door until the magnet engages and holds the metal plate. Pulling the door towards you with a moderate force will be sufficient to disengage the magnetic catch and open the door.

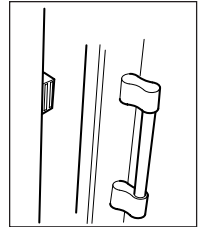

### Locker Door Catches (Paddle Latch)

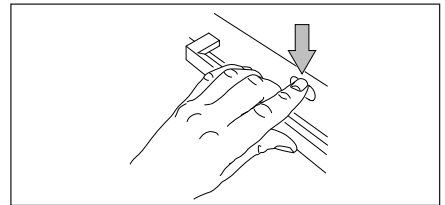

Your new Eiddis Motorhome is fitted with positive locking locker doors at high level.

These are operated by pressing down on the tab within the centre of the handle to release the internal catch.

### Concealed Latch

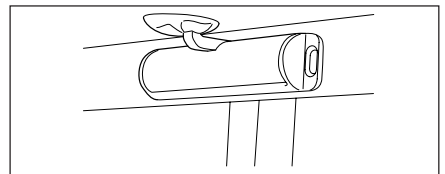

To open the locker, press the latch and pull the door towards you.



## THETFORD CASSETTE C260 TOILET

### Introduction

The Thetford Cassette Toilet is a high quality product. The toilet forms an integral part of your caravan bathroom, thanks to its functional design which combines modern styling and ease of use. The C-260 Cassette Toilet is manufactured from high quality synthetic materials which makes it a durable, user and maintenance friendly toilet.

The toilet is made up of two parts: a permanently fixed part and a Waste Holding Tank that is accessible from the outside. The removable Waste Holding Tank is located under the toilet bowl and can be removed via a door on the outside of the caravan. The Thetford Cassette Toilet is the solution to the sanitary problem in your caravan!

The operating instructions cover Thetford Cassette Toilet models C-260S, C-260CS (models connected to the vehicle's central water tank) and C-260CWE (model with its own flush-water tank). There are differences in the use of these models. Please ensure that you follow the instructions that apply to your toilet model.

### PARTS

- a) Removable Seat and Lid
- b) Swivelling Toilet Bowl
- c) Blade Handle
- d) Flush Button
- e) Waste Holding Tank Level Indicator
- f) Water Filling Door (only if toilet has own flush-water tank)
- g) Rotating Emptying Spout
- h) Automatic Pressure Release Vent
- i) Sliding Cover
- j) Removable Mechanism
- k) Vent Plunger
- l) Pull-out Handle
- m) Wheels
- n) Blade Opener
- o) Access Door to Waste Holding Tank

### Optional Features

- p) Electric Blade
- q) Automatic Ventilator
- r) Waste Pump-Out System
- s) Waste Holding Tank Multi-Level Indicator
- t) Flush-Water Tank Level Indicator (only if toilet has its own flush-water tank)

**Note:** Optional features can be bought from Thetford dealerships.

### Preparing for use (standard)

1. Open the access door on the outside of your caravan.
  2. Remove the Waste Holding Tank by pulling the safety catch (which holds the tank in place) upwards.
  3. Pull the Waste Holding Tank outward to the stop. Tip it slightly and take the tank fully out.
  4. Place the tank upright and turn the rotating emptying spout upwards. The emptying spout ensures that the tank can be easily and hygienically emptied.
  5. Remove the cap, with the measuring cup inside, from the emptying spout and pour the correct dosage of Thetford toilet fluid (see product label) into the holding tank. This avoids unpleasant smells and keeps the inside of the tank clean. Next add approximately 2 litres of water - enough to ensure that the bottom of the Waste Holding Tank is covered. For more information on Thetford toilet fluids, see last page of this manual. Screw the cap back onto the emptying spout and turn back to its original position.
- Note:** The Emptying Spout Measuring Cap is supplied in the same packaging as this manual.
- CAUTION:** Never add toilet fluid directly via the blade or the toilet bowl as this could damage the lip seal of the Waste Holding Tank. Always pour the fluids via the emptying spout.
6. Slide the Waste Holding Tank back into its original position via the access door. Make sure that it is secured with the



**Standard**

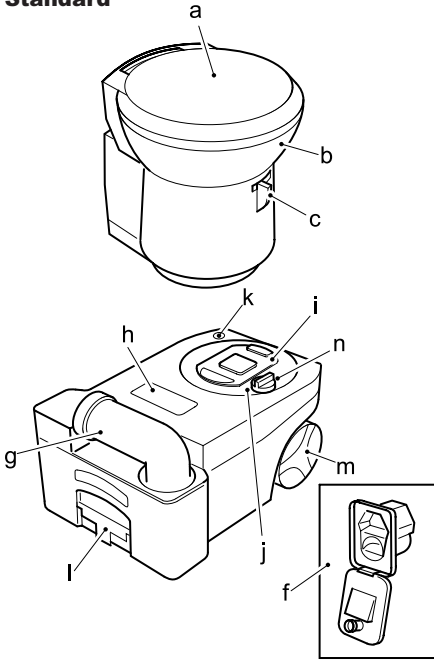

**Optional features**

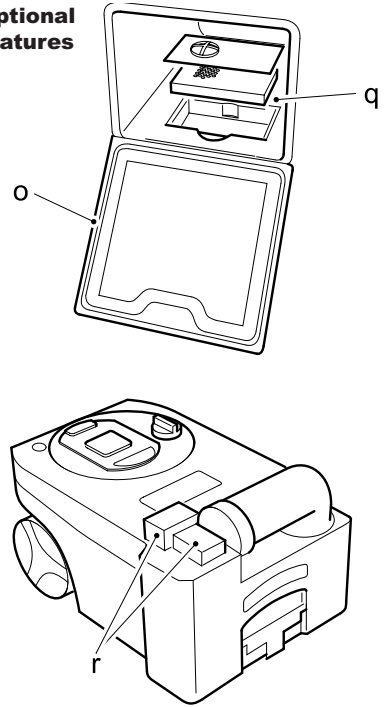

**Control panel (with optional features)**

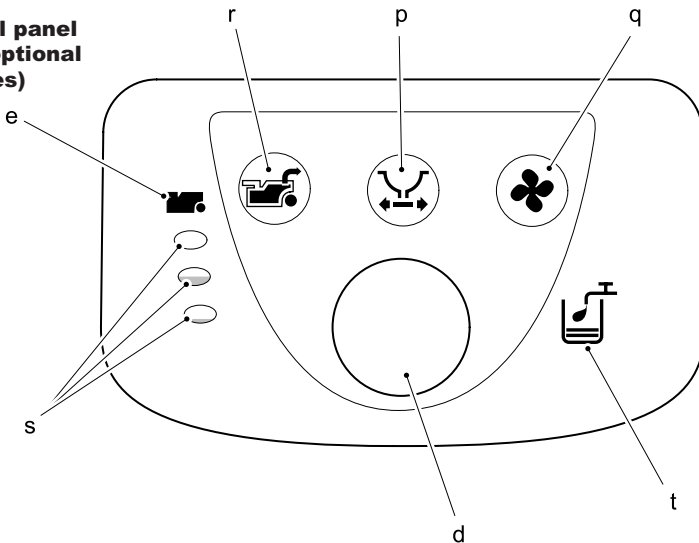



safety catch. Close the access door and lock it. Your Thetford toilet is now ready to use.

**CAUTION:** Never use force if you cannot get the tank back into place easily. This may cause serious damage. If blockage occurs, always check if the blade handle is in the correct (closed) position.

7. For toilets with own Flush-Water Tank: Open the water filling door and fill the flush-water tank with the correct dosage of Aqua Rinse. This Thetford toilet fluid keeps the flush water fresh and improves the flushing. Next, fill up the flush-water tank with clean water (approximately 8 litres) using a ferry can or hose. Your toilet is now ready to use.

### Using the toilet (standard)

8. Turn the bowl to the desired position with the lid closed and using both hands.
9. To activate the control panel, press the flush-button once. The control panel display will stay activated for approximately 5 minutes. Run some water into the bowl by pressing the flush button again briefly.
10. The toilet may be used with the blade open or closed. To open the blade, slide the blade handle under the toilet bowl sideways. After use, open the blade (if still closed) and flush the toilet by pressing the flush button for several seconds (if necessary re-activate the control panel). Close the blade after use.

**CAUTION:** If your toilet has its own flush-water tank, please make sure that you do not travel with a flush-water tank that is too full. Do not travel with water in the toilet bowl. Failure to adhere to this notice may result in water damage to your motorhome.

### Emptying

The Waste Holding Tank has a capacity of 18 litres and requires emptying when the red light (LED) on the toilet control display lights up, when the Waste Holding Tank only has capacity for approximately 2 more litres, which is no more than two to three further uses.

Make sure that the blade is closed. Open the access door located outside the vehicle, pull the safety catch upwards and remove the Waste Holding Tank.

11. Place the Waste Holding Tank in an upright position (Pull-Out Handle at the top, Wheels at the bottom). Slide the handle sideways - to the front of the tank - until it snaps out of its locked position.
12. Pull the handle up and wheel the Waste Holding Tank to an authorised waste disposal point.
13. Push the handle back into its locked position. Turn the emptying spout upwards and remove the cap from the spout. Hold the Waste Holding Tank in such a way that during emptying you can operate the vent plunger with your thumb. To empty the tank without splashing, depress the vent plunger while emptying the tank. After emptying, rinse the tank and blade thoroughly with water.

**CAUTION:** Do not seriously shake the tank or use high pressure water cleaners. This may cause damage to the tank's interior.

**Note:** The vent plunger should only be depressed once the emptying spout is pointing downwards. Prepare the toilet for re-use if required. Slide the Waste Holding Tank into the toilet and close the access door.

### Emptying with Optional Features

14. Waste Holding Tank Multi-Level Indicator: The lower lamp indicates that the Waste Holding Tank is almost empty; the middle lamp indicates that it is more than half full; when the upper lamp lights up, the tank needs emptying as it can only take 2 - 3 further uses.

**Note:** The Waste Holding Tank Level Indicator will flash when the holding tank is not present. In this case the toilet will not flush.

15. Waste Pump-Out System: When activating the control panel this feature automatically lights up. When the Waste Holding Tank Level Indicator illuminates, press the Waste Pump-Out button to pump out the waste from the holding tank into the vehicle's waste tank. The button



will flash while the waste is being pumped and will stop automatically (after approximately 5 minutes) when all waste has been transferred. If the vehicle's waste tank is full, the Waste Pump-Out light will flash rapidly and no pump-out will be possible until the central tank is emptied. (Check the level of the vehicle's waste tank on the vehicle's central console). After the Waste Holding Tank has been emptied, there will be approximately 1.5 litres of waste left in the tank. This is normal. Add 2 litres of water and a correct dosage of Thetford toilet fluids to the Waste Holding Tank.

**CAUTION:** It is vital that the correct amount of toilet fluid is added to ensure the proper breakdown of the waste in the holding tank. Only use the system when the tank is full. Using the system too often on an empty tank can cause damage to the pump, which could cause the system to fail.

## Cleaning and Maintenance

The toilet should be cleaned and maintained regularly, depending on the amount of use. To clean Thetford toilets, we advise using water and Thetford Bathroom Cleaner.

**CAUTION:** Never use bleach, vinegar or other powerful household cleaners that contain these substances. These may cause permanent damage to the seals and other toilet components.

## Toilet Bowl

- Squirt Thetford Bathroom Cleaner into the toilet bowl.
- Flush the toilet bowl with water and wipe down the rest of the toilet with a damp cloth.
- Clean seat and lid The seat and lid can easily be removed: Lift the seat and lid assembly and pull the round pins (inside the assembly) outwards from the pin holes. After cleaning, replace the seat and lid by positioning the round pins in front of the pin holes and push the lid and seat downwards.

- To keep your flush water fresh and to prevent deposits from forming in your toilet bowl, add a correct dosage of Aqua Rinse in your flush water tank, if present, on your toilet.

**Tip!** For a really shining toilet, dry with a soft dry cloth after cleaning.

## Waste Holding Tank

To keep your Waste Holding Tank fresh and clean, Thetford has developed a number of different toilet fluids. Thetford toilet fluids suppress smells, reduce formation of gas, promote breakdown of toilet waste and increase the life span of a mobile toilet. We advise a thorough cleaning of the Waste Holding Tank once each season. Next to using Thetford's Cassette Tank Cleaner, the powerful cleaning agent for the periodical cleaning of the Waste Holding Tank of your toilet, we suggest the following:-

- Remove the removable mechanism from the Waste Holding Tank by turning it anti-clockwise and rinse it under a tap.
- Remove the cover plate from the Automatic Pressure Release Vent by prising it up using a small screwdriver. Use one hand to push the Automatic Pressure Release Vent open while holding the float of the Automatic Pressure Release Vent on the inside of the tank with the other hand. Push the float upwards, turn it 180 degrees and remove it from below. Remove the rubber seal underneath the float. Rinse the float and rubber seal under a tap. Replace the rubber seal and float for the Automatic Pressure Release Vent using the same method in reverse.

The rubber seals in the toilet (the lip seal, the mechanism seal, the automatic pressure release vent seal and the cap seal) should be regularly cleaned with water and treated with Thetford High Grade Seal Lubricant. This will ensure that the seals remain flexible and in good condition. If the toilet is not to be used for any length of time, it is important to treat the seals with Thetford High Grade Seal Lubricant after cleaning.



**CAUTION:** Never use Vaseline or any vegetable oil except olive oil. These may cause leakage or malfunction. The lip seal is a part of the toilet that is subject to wear. Depending upon the extent and manner of use, the seals will become less effective and will need replacing periodically.

## Winter operation

You can use your Thetford Cassette Toilet as normal in cold weather as long as the toilet is situated in a heated location. If there is a risk of freezing we advise that the toilet is drained by following the instructions under 'Storage'. For environmental reasons the use of antifreeze, such as that used in car radiators, is not recommended.

## Storage

It is important that you follow the instructions below if you do not expect to use your Thetford toilet for a long (winter) period.

- Activate the Control Panel by pressing the flush button. Open the blade and press the flush button until water stops flowing into the bowl. Close the blade. Open the access door on the outside of your caravan and empty the Waste Holding Tank at an authorised waste dump. Follow the instructions for cleaning and maintenance. To allow the Waste Holding Tank to dry, do not place the cap back on the emptying spout of the tank.
- 16. If the toilet has its own flush-water tank, place a sufficiently large bowl under the drain tube to catch the remaining water from the flush-water tank and remove the drain plug. When no more water exits, put the drain plug on the drain tube, put it back in its original position and close the access door. If the toilet is connected to the vehicle's water tank, please follow your vehicle's instructions for draining the central water system. If your toilet is optionally featured with a Waste Pump-Out System, take out the Waste Holding Tank and completely clean it (see Cleaning and Maintenance). After cleaning, fill it with water, put it back and empty it via the waste pump-out system. Repeat this twice.

## Toilet unit malfunctions

Contact your dealer or a Thetford Service Centre.

We advise draining the fresh water tank prior to travelling. Antifreeze should not be required if the motor home is heated. If you do wish to use antifreeze, brands containing the following properties may be used in the fresh water tank:

- Ethylene glycol
- Mono-Ethylene glycol
- Propane-diol
- Glycerol
- Ethane-diol
- Glycol

Never use alcohol based antifreeze, i.e. Methanol, Ethanol, and Iso-propanol.





### TELECO TV AERIAL

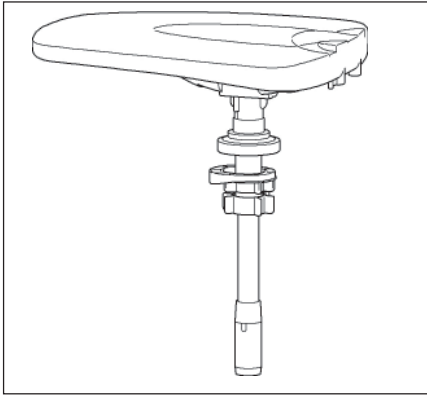

#### Instructions for the reception of horizontal or vertical polarity signals

In some areas certain TV signals are transmitted with horizontal polarity while others are transmitted with vertical polarity.

This antenna can be positioned both horizontally and vertically by simply turning the knob at the bottom of the mast.

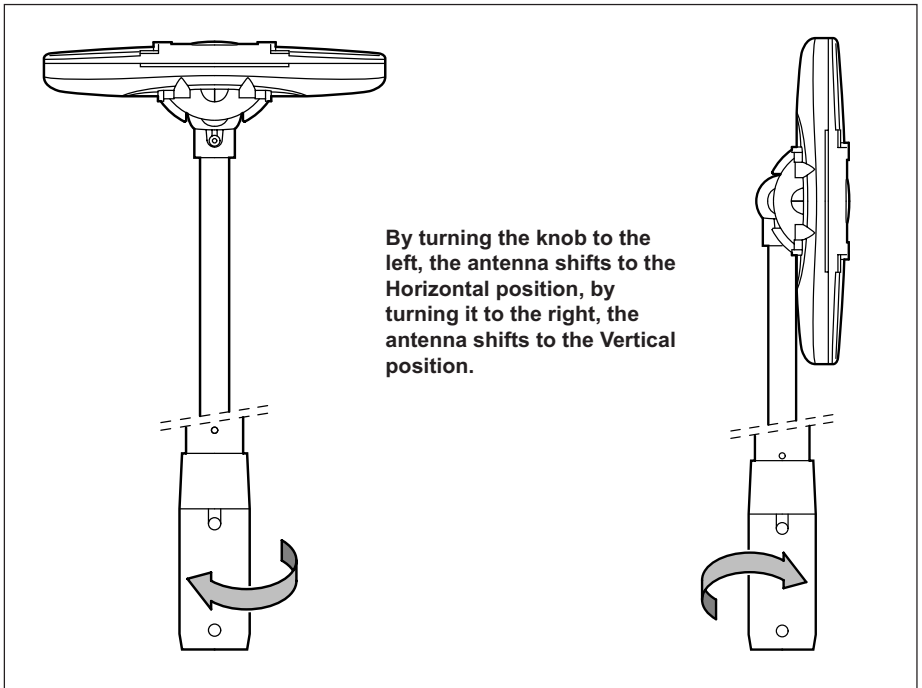



## Connection to the amplifier

Connect the lead exiting from the pole to the ANT input of the amplifier. Connect with the relevant lead, the TV connector of the amplifier with the television. Connect the amplifier to 12 Vdc source, making sure you do not invert the + and - terminals.

## Operating Instructions

- 1) Rotate slowly the dB dial of the amplifier clockwise to the maximum +
- 2) Tune the television to a channel available in the area where you are located.
- 3) Rotate and lift the antenna via the suitable pole until you get the best image on the TV.

## Useful Tips

Not all the television signals you can receive in the zone where you are located will necessarily originate from the same direction. So if the quality of a programme image is poor try rotating the antenna as the signal may be coming from a direction different from the others.

## Gain Adjustment

With the dB dial turned all the way clockwise, amplifier sensitivity will be at maximum and it is therefore able to receive the weakest signals. If, instead, the signals are too strong the images on the TV screen can have some stop or macroblocks. In this case rotate the dB dial anti-clockwise slowly until the image is perfect.

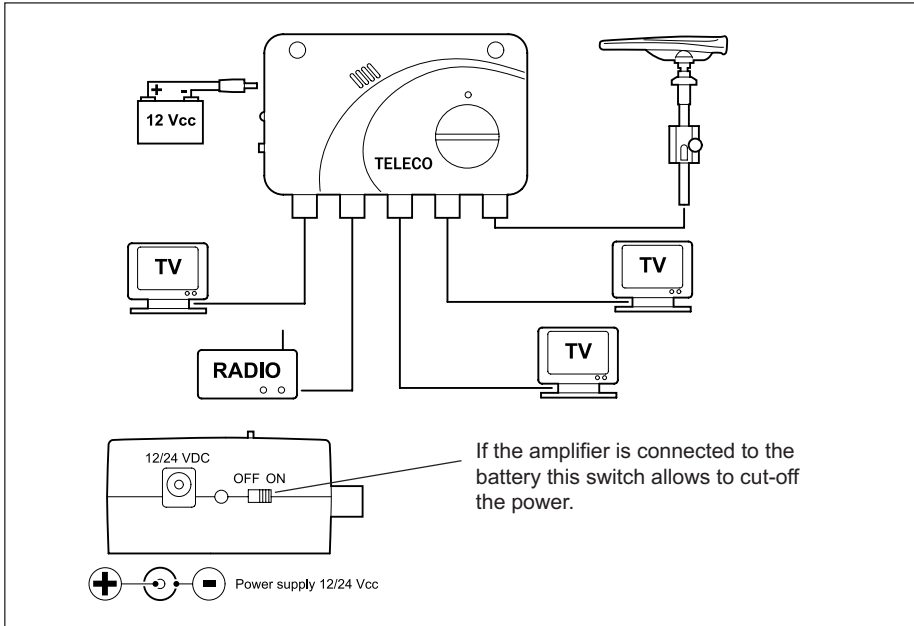



## HOW TO USE YOUR TV AERIAL

### Digital TV set-up guide

#### Connect aerial and power

Fix the TV to a bracket or place on a stable, flat surface, then connect the aerial cable and power lead to the TV and sockets.

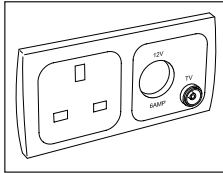

#### Check the power is on

The aerial needs power to work correctly; check that the power is switched on (Switch on either the mains and/or battery power to the vehicle) both power sources switch on the aerial (12 Volts).

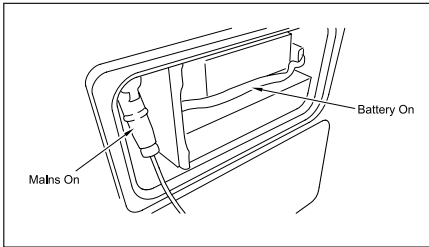

#### Tune in TV and choose transmitter

Switch on the TV and tune in the channels. If the vehicle is moved or a different socket is used you might need to re-tune TV. If the first transmitter picked up has poor quality pictures, then re-tune and pick another transmitter.

With Digital TV's there will be a re-tune button on the remote control use this feature and then choose manual re-tune.

Most digital TV's will also allow you to choose the transmitter which is normally available via the Menu function.

This will vary by TV manufacturer so if you have any problems undertaking this task please refer to your TV manual.

## TROUBLESHOOTING GUIDE

### Check aerial/radio fuse

If there is no power, check the 5 amp fuse located within the PDU marked radio is in working order.

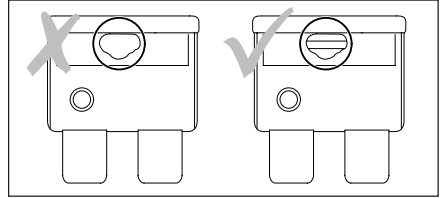

### Check TV monitor

Check the TV is working correctly by ensuring that the channels tune in correctly in your home. If the TV does not pick up the expected number of channels we would recommend you get the TV checked out.

See step 6 shows how to tune your TV

### Number of channels picked up from your house connections

DTV : 0	Programme(s)	<b>X</b>
Radio: 0	Programme(s)	
Data : 0	Programme(s)	

DTV : 72	Programme(s)	<b>✓</b>
Radio: 24	Programme(s)	
Data : 21	Programme(s)	

### Check the coax lead is of good quality

Check that the TV aerial lead is of good quality (Normally cheap leads from the supermarket give reception problems, they are normally mass produced and made to a wider tolerance).

Ensure the coax lead from the aerial socket to the TV is suitable for digital reception reception (if in doubt, ask for advice).

### Check location for signal strength

Check that the digital tv signal strength where the vehicle is situated is Very Good to Good.

Go to: [www.digitaluk.co.uk](http://www.digitaluk.co.uk)

Enter the postcode and check signal strength.



**Note:** Sometimes transmitters are being repaired or upgraded

Go to: [http://www.digitaluk.co.uk/help\\_and\\_advice/engineering\\_works](http://www.digitaluk.co.uk/help_and_advice/engineering_works)

Check if signal is OK that day / week.

## Check there are no obstructions

Is the vehicle outside in an open space?

Check that the vehicle has no obstructions:

House lean to/canopy

Trees (also blowing in the wind)

House or other buildings

Hills

Large vehicles

In a valley etc.



## Understand digital signals

Digital signals have what the industry calls the Cliff effect.

The Cliff effect is either you have a picture or not within a very small difference of signal strength. This happens with both weak and strong signals.

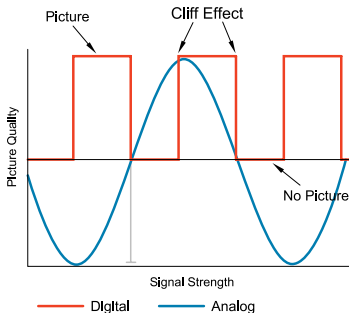

## Troubleshooting guide - Checklist

Action	✓ or X
Check aerial fuse	
Connect aerial and power	
Check the power is on	
Tune in TV and choose transmitter	
Check TV monitor	
Check the coax lead is of good quality	
Check location for signal strength	
Check for obstructions	
Understand digital signals	

**If after following this guide you still have problems, contact your local Retailer or Approved Workshop.**



## HOW TO MAKE UP YOUR BEDS

### Encore Day and Night

The front double bed is made up by lifting the two side beds up and pulling them together to meet in the centre.

DAY VIEW

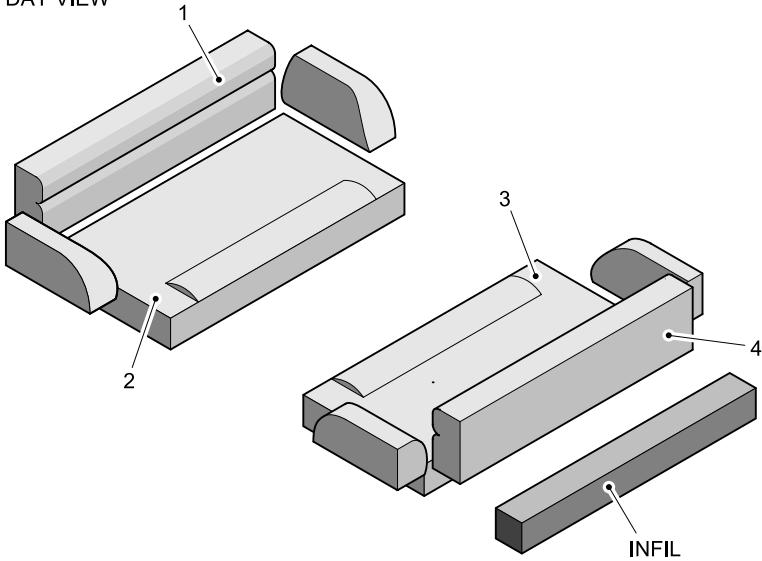

NIGHT VIEW

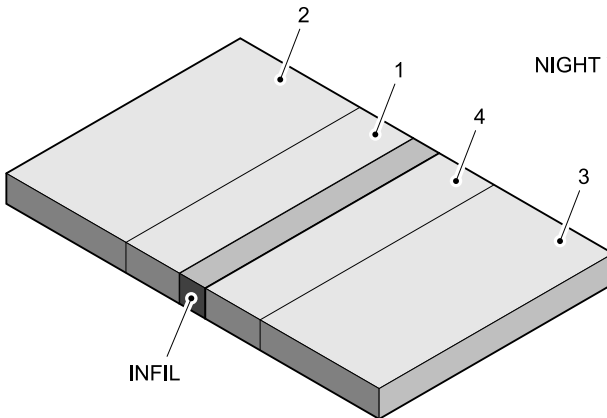



## Whale Easi-Slide Socket

How to open the socket lid

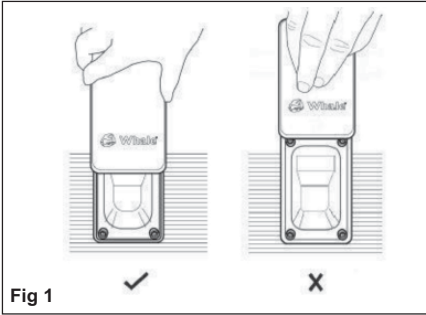

Fig 1

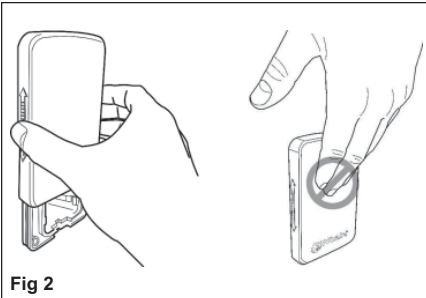

Fig 2

## Safety Information

This appliance is **not** intended for use by persons (including children) with reduced physical, sensory or mental capabilities, or lack of experience and knowledge, unless they have been given supervision or instruction concerning use of the appliance by a person responsible for their safety.

- Children **must be** supervised to ensure that they do not play with the appliance.
- Any alteration to the appliance, misuse or use of non-original Whale parts may invalidate the warranty. Non observation of the installation and operating instructions will lead to cancellation of the warranty and exclusion of liability claims. It also becomes illegal to use the appliance if incorrectly installed, and in some countries may make it illegal to use the vehicle.

## Additional Safety Information for Main In, Mains Out and Multimedia 3 in 1 Sockets (Where Applicable)

All work must be carried out by a competent person as defined by BS7671 Part 2/IEC 60364.

## Safety

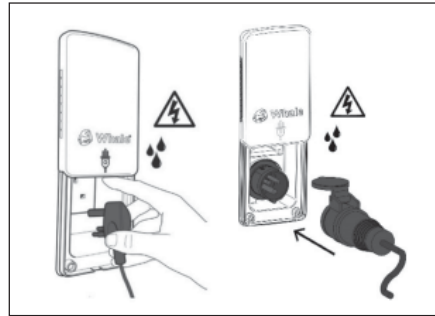

- If the mains in or out supply cord is damaged, it must be replaced by a special cord or assembly available from the manufacturer or its service agent.
- For use in recreational vehicles only.

## Additional Safety Information for Onboard Tank Fill, On Board Tank Fill +12v and Water In / Out Sockets ( Where Applicable)

- For use in recreational vehicles with a typical water system pressurised up to 3 bar.
- When using the **Water In Socket**, Whale recommends that you keep the o-rings lubricated for easy and secure connection/removal of the plug to socket. Use a water-based lubricant such as silicone grease. **Please note: Do not use vaseline or vegetable oil to lubricate o-rings.**

## Additional Safety Information for External BBQ Outlet Socket ( Where Applicable)

Whale BBQ sockets including the gas hose connector must be installed and serviced by a Qualified Gas Engineer in accordance with these installation instructions and BS EN 1949-2011.



**WARNING: Care must be taken when using the external BBQ outlet socket. NEVER barbeque next to an awning or tent.**

**WARNING: Only for use as an outlet point for gas, never connect a gas bottle directly to the outlet.**

In the unlikely event of leaks in the gas system, or if there is a smell of gas:

- Extinguish all naked flames
- Switch off all appliances and do not operate any electrical switches
- Turn off all gas appliances
- Open windows and doors for ventilation
- Do not smoke
- Shut off gas connection
- Immediately ensure that the system is thoroughly checked by a **Qualified Gas Engineer**.
- Regularly inspect gas tap to ensure inside nozzle is free from debris, and gas connection to the rear has not been damaged.
- Supply to external appliance **should not be** less than 0.03 bar and not greater than 0.05 bar.







## SECURITY

Theft deterrent, prevention and security of your motorhome is taken very seriously at Elddis. That is why we have provided a combination of standard features and optional extras designed to deter and prevent thieves from stealing your property. And in the unlikely event that they should succeed, aid the identification, speedy recovery of your property and assist in the prosecution of the thief.

### Tracker (Option)

Your motorhome can be fitted with TRACKER.

Your dealer may have registered the motorhome with TRACKER and confirmation sent to you via email.

If it has not been registered you can easily do it yourself.

Open the TRACKER registration portal

[www.tracker.co.uk/elddis](http://www.tracker.co.uk/elddis)

TRACKER VLU and Motorhome VIN

Numbers are matched and confirmed with the vehicle model

Enter Dealership name from dropdown menu

Enter customer details including email address

Confirmation sent to customer email

One year subscription will begin

TRACKER will contact customer towards the end of the one year subscription period with the options available.

or call TRACKER directly on 0870 606 1269

### Motorhome Theft

The theft of a motorhome can occur in the most unlikely circumstances; from a motorway service area, even from an owner's driveway. Secure all windows and doors when your motorhome is unoccupied, even if only for a short length of time.

### VIN CHIP

VIN CHIP is the theft deterrent and identification system for touring caravans and motorhomes. VIN CHIP has been launched to deter criminals looking to steal touring caravans and motorhomes and help aid the identification and recovery. VIN CHIP is unique as it uses both visible and invisible markings containing a specific 17 digit VIN.





## CARE OF YOUR MOTORHOME

This section of the guide is devoted to the care, cleaning and general preservation of your motorhome in order to retain its showroom condition.

All the adhesives used to seal exterior components are mould resistant but not mould proof. In order to ensure that these adhesive beads are maintained in the best possible condition and that their appearance does not become unduly affected by mould growth, it is recommended that they are regularly washed and cleaned using a suitable proprietary caravan or car cleaning wash product.

### Exterior Body Shell

Elddis Motorhome Bodies are constructed from the highest quality materials. The fully insulated floor is a constructed timber frame with plywood internal floor and a GRP underskin for added water resistance and insulation laminated together for strength. The walls comprise an insulated foam sandwich having one piece GRP sides for ultimate resistance to minor damage and vinyl coated plywood internal finish. Wooded framing is positioned within the sandwich to add strength. The latest technology is used to produce the extremely well insulated and robust, yet lightweight sections.

**CAUTION:** Under no circumstances should an abrasive or harsh cleaner be used. Do not use a pressure washer.

### Glass Fibre Reinforced Plastic (GRP)

GRP components need to be washed, waxed and taken care of like a car. Chemicals and dirt can collect during storage, and the gel coat can be stained or marked when chemicals combine with rain or dew. Most stains or marks can be removed with Blue Diamond black streak remover, but more stubborn marks may require a (fine grit) rubbing compound such as Farcela G3. To help keep your GRP components looking almost like new, it is wise to wash the parts monthly (or more frequently) using Autoglym products, but avoid using strong alkaline (e.g. trisodium phosphate) or acidic cleaners or abrasives. Waxing the components once or

twice a year with a good grade paste wax will help to maintain the colour and finish.

### Acrylic Windows

Your motorhome is fitted with shatter resistant acrylic windows. To preserve their clarity and unblemished transparency it is essential that the following cleaning instructions are strictly adhered to: Road grit, dust, sand, flies, bird droppings etc., should be washed off using plenty of cold water do not use a sponge to clean off heavy dirt deposits. Any remaining dirt should be washed off using a soft cloth and warm water. Under NO circumstances should any abrasive cleaning agents, household detergents or proprietary cleaning fluids be used. Wash the window again using only cold water and dry off with chamois leather.

**Please note:** Should scratches appear on the acrylic windows these can often be removed with an acrylic polish. E.g. ICI Perspex polish. Gentle polishing with a liquid metal polish, i.e. Brasso may also have the desired effect - consult your retailer BEFORE attempting to remove any but the slightest scratch.

### Window Blinds & Flyscreens

To clean the blinds and flyscreens, moisten a soft cloth or sponge with a small amount of water and mild soap suds and gently wipe dirt off. Allow to dry before retracting, failure to do this could result in mildew forming.

### ABS - Wheel Spats & Panels

To preserve the appearance of all ABS panels and fittings road grit, dust, sand, flies, bird droppings etc., should be washed off using plenty of cold water. Any remaining dirt should be washed off using a soft cloth and warm water. Under NO circumstances should any abrasive cleaning agents, household detergents or proprietary cleaning fluids be used. Wash the ABS material again using only cold water and dry off.

### Interior Walls

Your motorhome interior walls will only require a wipe over with a damp cloth and soap and water to keep them in a 'showroom' condition.



## **Carpets, Upholstery And Curtains**

Vacuum clean carpets and upholstery to ensure a long life, marks on cushions can be removed using a mild upholstery shampoo with the minimum of water. Curtains should be dry cleaned only.

## **Washroom And Handbasin Fittings**

These should be cleaned using a non abrasive household cleaner. Always put the cold water into the hand basin before adding the hot in order to preserve the finish of the thermoplastic formed basin.

Cleaning instructions for all chrome plated products – (taps, wastes, bathroom accessories, etc.)

Alcohol, solvents and solid detergents, liquids containing acid or aggressive solutions, anti-calcareous products, abrasive sponges or steel wool should absolutely be avoided since they could corrode in an irreparable way the outer surface of the products.

**Please Note:** Under no circumstances should alcohol, spirit or solvent-based liquids be used on GRP or ABS plastic panels as these substances may react with the material and cause visible damage.

## **Shower Trays**

Only clean your shower tray using soap and water. Do not use chemical based cleaning agents as this may attack the material of the tray.

## **Water Systems**

The water systems, and in particular storage tanks, in motorhomes are susceptible to contamination by bacteria if care is not taken with their use and cleaning. The symptoms caused by bacterial contamination are not purely limited to gastro-intestinal diseases, but may also manifest themselves as ear, nose, throat, and eye or skin infections. It is therefore important that you carry out the following procedure prior to using the motorhome each time, even if you boil or filter all water you use for drinking.

**Please note:** If your motorhome is not going to be used for an extended period of time please refer to section 12-1 Storage.

## **Water Containers**

- (i) All water remaining in any water container should be disposed of so that the container is empty.
- (ii) The outside of external water containers should be thoroughly cleansed and washed down to remove any dirt, dust or other contaminant. Water at a suitably hot temperature containing an appropriate detergent is recommended for this purpose. Water should then be put into the container, swirled round, and then emptied out.
- (iii) All containers should then be totally filled with water containing an appropriate disinfectant / sterilising solution and allowed to stand for the recommended contact time.
- (iv) The solution should be emptied from the container.
- (v) External containers should be inverted whilst stored overnight (if possible).
- (vi) Containers must be filled with mains water only and mains water only should be used for the above cleaning procedure.
- (vii) On no account should garden hoses be used to fill water tanks.

## **Internal Water Systems**

- (i) Drain down the system. (Open all taps to allow air in, enabling the system to drain quickly).
- (ii) Fill the system by using the pump with a disinfectant / sterilising solution. (Check that the solution at full strength appears at all taps/showers). Allow to stand for the recommended period of time.
- (iii) Drain the system down completely.
- (iv) Thoroughly clean the outside of all taps/ connectors with a cloth soaked in the disinfectant / sterilising solution.
- (v) Flush the system through with clean drinking water until no traces of disinfectant / sterilising solution can be detected at any tap.
- (vi) Suitable sterilising chemicals are available from your Elddis Retailer, accessory shop, chemists, or homebrew shops. It is not, however, recommended to use bleach or sodium metabisulphide.



## **Thetford Toilet**

### **WARNINGS**

**Cold Weather Use** - To prevent freezing during cold weather use, add antifreeze to the toilet system fresh water tank. Use a non-toxic (propylene glycol) type of antifreeze. Refer to chart on container to obtain level of protection.

**Warmer Weather Use** - In warmer weather or longer intervals between emptying the waste tank you may require additional toilet fluid. Use only Thetford toilet fluid to achieve the best results.

### **CAUTIONS**

- Never add toilet fluid directly into toilet bowl.
- Do not use strong household detergents or cleaners that contain chlorine, solvents or acid contents.
- High Altitude and Hot Weather Use - with large temperature differences and changing heights during driving, pressure can start to build up in the waste holding tank, causing contents to splash upward upon opening the valve blade if opened too fast.

## **Changing A Wheel**

Refer to base vehicle handbook.





## STORAGE

### LONG TERM & WINTER STORAGE

If your motorhome is to be stored for any length of time, especially over the winter period, the following operations are recommended:

- (i) Ensure all windows, roof lights, habitation and exterior locker doors are closed firmly and locked.
- (ii) Remove all soft furnishings which could be affected by damp conditions
- (iii) Clean the motorhome inside and out.
- (iv) Drain the water system.
- (v) For winter storage and to prevent frost damage all taps must be left in the open position. For those motorhomes with lever taps please ensure the taps are left in the central position.
- (vi) All blinds and flyscreens should be left in the retracted position. Check all fixed ventilation apertures are not obstructed.
- (vii) Ensure that the refrigerator/freezer compartment doors are left open during storage.
- (viii) Check that the site you have chosen to store the motorhome is open, fairly high and dry and if possible not exposed to gales etc.

### Motorhome Covers

Covers may be used to protect your new Elddis motorhome provided that the cover used is of a breathable type.

Lower the TV antenna and ensure the cover is well tied down to avoid the cover being punctured.

Your motorhome must be ventilated every 4 to 6 weeks if it is to be stored with a cover in place.

## Battery Maintenance

### Storage

Ensure that the leisure battery is fully charged before placing the vehicle into storage.

Check the battery state every month, if the terminal voltage drops below 12.07V then re-charging is necessary.

Charging should be carried out in a cool, dry well ventilated area.

Do not place the battery onto cold surfaces such as concrete as this will affect the battery's ability to charge.

Should the motorhome be stored for a prolonged period of time it is strongly recommended that the motorhome is fully serviced before the commencement of use. Your retailer will ensure that your motorhome is safe, secure and ready for your enjoyment.

**Please note:** It is recommended that you place a bowl of salt within your motorhome to absorb any moisture during the winter months.







## MOTORHOME HABITATION WARRANTY COVER

### Introduction

At Eddis we are confident that our new motorhomes are engineered using the latest manufacturing techniques and advanced materials technology ensuring that, when buying one of our products, you are buying the very best. We extend this philosophy to our customers by offering long term peace of mind and reassurance through our extensive warranty cover.

Your warranty cover commences on the day your new motorhome is purchased and comprises of three key elements:

1. The base vehicle warranty cover is provided by the original manufacturer (details are included separately in the user handbook).
2. Three year Eddis manufacturer's warranty
3. Ten year Eddis body integrity warranty

### Scope

This applies to all new products and is a guide intended to give a brief overview of the warranty terms applicable to your vehicle.

### Conditions of use

Your new motorhome has been designed as a leisure vehicle only. The warranty will not be given if the vehicle is used under the following circumstances.

- Used for hire
- Used as a permanent residence
- Used for racing or time trials
- Damage resulting from freezing, accident or fire damage

### Exclusions

- No liability will be accepted for fair wear and tear, including mould or discolouration of adhesive. Damage including rodent damage, wilful damage or negligence from abnormal working conditions will not be covered.
- Condensation is not covered under the warranty agreement.

### Three year manufacturer's warranty

**Year 1 warranty** - Covers all original components, forming part of the original product specification excluding normal wear and tear.

**Year 2 and 3 warranty** – Covers all original components, forming part of the original product specification, excluding the following items:

- Normal wear and tear
- Microwaves
- Batteries
- Windows and glass
- All soft furnishings including mattresses (2-year warranty cover)
- Entertainment equipment
- LED lights
- All panels and plastic products
- Minor adjustments
- Ironmongery and corrosion of metallic components
- Electrical connections
- Floor coverings

We would recommend that customers have their vehicle serviced on or before the due date to ensure that all warrantable parts are identified before the expiry of the component.

### Ten year body integrity warranty

Eddis products are covered against water ingress manufacturing defects for 10 years from the original date of purchase of a new product. (6 years for subsequent owners from the 1st owners original date of purchase).



## Reporting a fault

In the unlikely event that you experience a problem with your motorhome please contact your retailer.

It is with the retailer that your contract of sale exists and consequently they have the responsibility to ensure any complaints and warranty issues are addressed. Any Elddis approved Retailer / Service Centre are able to undertake any warrantable work at their convenience or discretion, but are not obliged to do so, if the vehicle was not purchased from them.

All Elddis products are classed as portable and therefore all work under warranty requires the motorhome to be delivered and collected from the approved chosen Elddis agent.

**The cost of transporting the motorhome by any means to and from the place of repair is the responsibility of the owner.**

In order to comply with the terms of the above cover the following conditions must be met.

## Conditions attached to the warranty cover

- You must retain the original sales invoice for the motorhome.
- All new motorhomes must be registered with Elddis within 6 weeks of purchase. Your retailer can forward this information to us. Please keep us informed of any name or address changes by using the Notification of Change to Name and Address form.
- The motorhome must have an annual service and damp check carried out by an Elddis approved Retailer / Service Centre or NCC Approved workshop or NCC equivalent standard as set out in this handbook. Original invoices, service checklists and damp reports must be retained as proof that the annual services have been carried out in accordance with our warranty terms.

## • Service intervals:

- a) In years 1, 2, and 4 through to 9 the service must be completed no more than 60 days either side of the anniversary of the date of purchase.
- b) In Years 3 and 10 the service must be completed no more than 60 days on or before the anniversary of the date of purchase and must not exceed this date.
- c) For second owners the service in years 3 and 6 must be completed no more than 60 days on or before the anniversary of the original date of purchase. This date must not be exceeded.
- d) No service interval should exceed 14 months.
- e) **Failure to service the vehicle within the specified time limits will invalidate your warranty.**

We would recommend that you have your service carried out by an Elddis Approved Retailer/Service Centre, who are able to assist you should warranty work be required. Should you choose to have your service carried out by a non Elddis Approved agent, an additional charge may be payable by the customer to cover the second inspection.

- The motorhome must be made available for repair within 6 weeks of the date of inspection for the purpose of carrying out the repair work.

Elddis reserves the right to inspect the vehicle before work commences. Failure to do this may invalidate your claim.

Warranty work may only be undertaken by an Elddis Approved Retailer/Service Centre.

- Elddis will pay the costs of remedial work to the repairer, only after approved work has been carried out. The cost of transporting, towing or moving the motorhome by any means to or from the place of repair is the responsibility of the owner.
- The Policy is not retrospective and is applicable to 2012 model year motorhomes onwards.



## WARRANTY



- No liability will be accepted for any consequential loss, damage, costs, expenses or other claims for compensation arising which were not reasonably foreseeable by both parties when the motorhome was originally purchased.
- No alteration may be made to the original construction.
- In the event of a dispute an arbitrator may be appointed, this is a discretionary service offered by us as appropriate. Should we deem it necessary to appoint an independent arbitrator, you may be required to pay a £250 deposit in advance of the inspection. If the arbitrator finds in favour of the customer then the deposit will be returned, otherwise the customer will lose their deposit.  
Elddis reserve the right to inspect the motorhome at any time.

### Mains electrics

It is recommended that you have your mains electrics system inspected by a NICEIC approved contractor every 3 years.

### Transfer of ownership

If you purchase this vehicle as a used vehicle it may be possible to transfer the unexpired term of the warranty cover (up to a maximum of six years commencing at the original date of purchase from the first owner) and is as follows:

1. Three year manufacturer's warranty
2. A maximum of six years' body integrity warranty

The warranty is subject to the usual terms and conditions set out in the handbook and is only transferable on payment of a £50 administration fee. Full documentary evidence that the motorhome has been serviced annually should be provided at the time of transfer, in accordance with the terms and conditions of the warranty stated in the handbook. Transfer of ownership must be completed within three months of change of legal ownership. Please complete the Notification of Change of Ownership form in your handbook. Failure to do this will negate the remaining warranty.

This warranty does not affect the purchaser's statutory rights. The warranty shall be governed and construed in accordance with the laws of England and the parties irrevocably submit to the exclusive jurisdiction of the courts of England.

For second owners the service in years 3 and 6 must be completed on or up to 60 days before the anniversary of the first owners date of purchase and must not exceed this date.

### NON WARRANTY REPAIRS

Should you require any replacement parts for your motorhome it is necessary that you contact the Retailer from whom you purchased the motorhome or any Elddis approved Service Centre and give the following information, which will help in identifying the required component:

- (i) Model and make of motorhome
- (ii) VIN number
- (iii) Description of required part
- (iv) Photograph, size or diagram of required part

**Please note:** All parts must be ordered and supplied through an approved Retailer or Service Centre.

### REMEDIAL WORK

Elddis, together with its suppliers is continually undertaking extensive research into testing, remedial work procedures and materials such as structural bonding adhesives, gaskets and tapes. Therefore, if for any reason your new motorhome is damaged or requires remedial work then we would recommend an approved Elddis Retailer or Service Centre should undertake such work.

All such work must be undertaken using only approved Elddis genuine parts, recommended structural bonding adhesive and following Elddis procedures. Elddis will also undertake to supply certain specialist repairers with the necessary spare parts. In this case, your selected repairer must contact the PARTS DEPARTMENT with all enquiries.

**Base vehicle warranty** - Please refer to base vehicle handbook and/or website.





## **MOTORHOME CONSTRUCTION - MAIN COMPONENTS**

The following is a brief description of the main components used in your motorhome. More comprehensive descriptions can be found in the equipment manufacturers literature held in the Owner's Information Pack.

### **SOLID CONSTRUCTION BODY SHELL**

Elddis Motorhome Bodies are constructed from the highest quality materials. The fully insulated floor is a constructed timber frame with plywood internal floor and a GRP underskin for added water resistance and insulation laminated together for strength. The walls comprise an insulated foam sandwich having glass fibre reinforced plastic (GRP) exterior surface and vinyl coated plywood internal finish. Wooded framing is positioned within the sandwich to add strength. The latest technology is used to produce the extremely well insulated and robust, yet lightweight sections.

### **WINDOWS**

Windows are all of a double glazed acrylic construction and the door frames are extruded aluminium.

### **INSULATION**

Elddis motorhomes are built to comply with grade 3 thermal insulation in accordance with the European Standard BSEN 1645 part 1. This states that an average temperature difference of at least 35°C between the inside and outside temperatures should be achieved when the outside temperature is -15°C and an internal temperature of 20°C.





## ELECTRICAL DRAWINGS

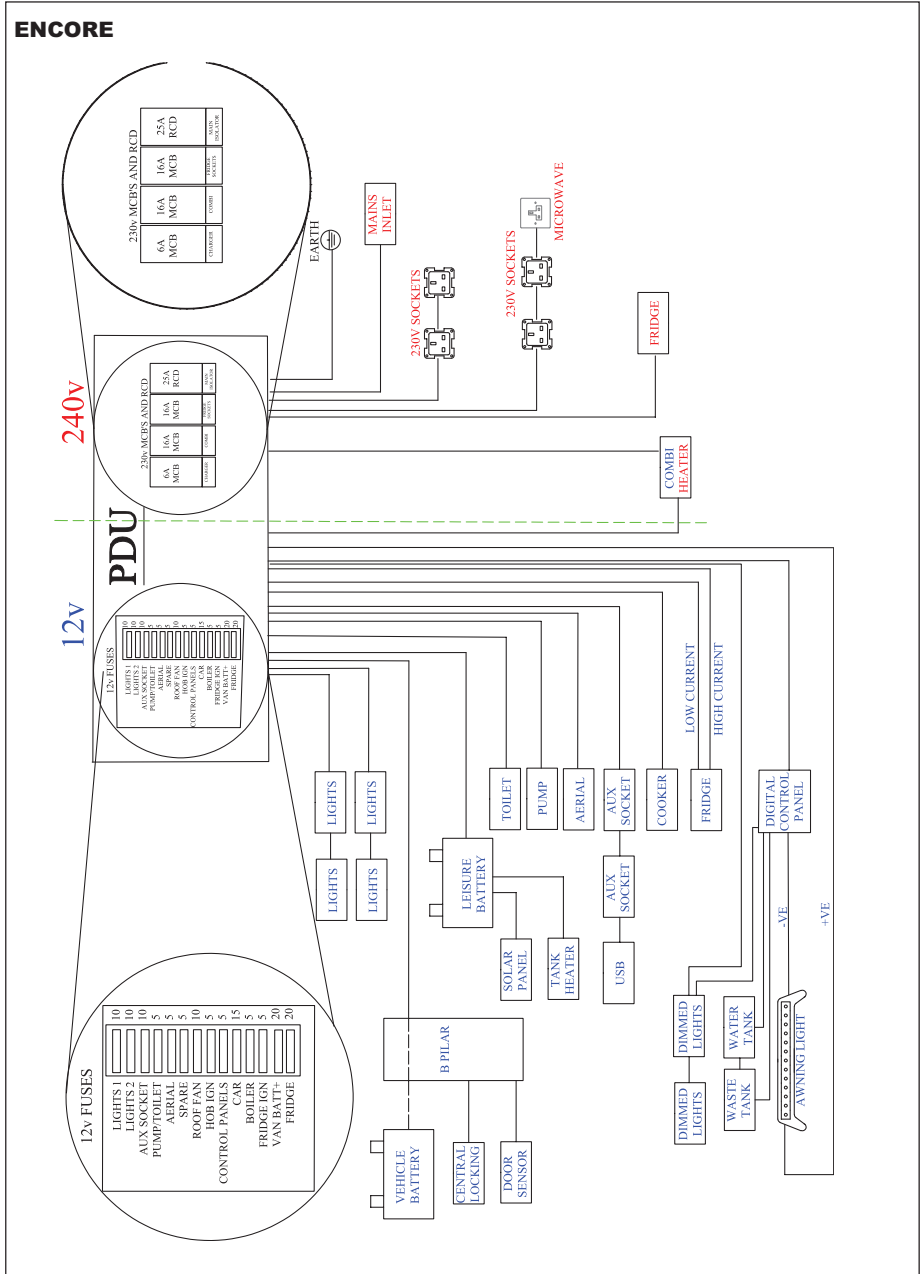







## GENERAL QUESTIONS

### **Q: Where Can I Obtain Your Latest Brochure?**

A: Our latest brochures are available from Approved Retailers or can be viewed and printed from our website [www.elddis.co.uk](http://www.elddis.co.uk). A request form can also be completed should you wish to receive a printed copy of our latest brochures.

### **Q: Why Is the Handbook Not Specific To My Model?**

A: Many of the components used in the manufacture of our motorhomes are identical throughout our model ranges, so we produce a generic handbook, which covers all models manufactured within a range for that season. If the literature supplied with your motorhome does not answer your question then please contact your Retailer for further assistance.

### **Q. I Require Technical Or Other Information, Who Can Help Me?**

A. The majority of information you require is available through your Elddis Retailer.

### **Q - Can You Tell Me The Second Hand Price Of My Motorhome?**

A - As a manufacturer we are not involved in the second hand market. You should contact a Retailer. They should be able to give some indication of market value.

### **Q: Can I Fit A Bicycle Rack/Top Box/Air Conditioning To My motorhome?**

A: It may be possible to fit accessories to your motorhome but this will depend upon the internal construction of the roof/walls and whether they can support the weight of the accessory. If it is possible your Retailer will be able to advise you, (or alternatively they will obtain confirmation and a drawing where necessary, from Elddis). Please note that weight of any accessories will reduce your User Payload allowance.

### **Q: My Interior Lights Are Not Working, What Do I Do?**

A: It is possible that all of the 230V mains electrical equipment may not be operated simultaneously. Check fuses, battery connections and power supply (master light switch). Refer to your Retailer for further assistance.

**PLEASE NOTE:** The internal lights in your motorhome will not operate whilst the motorhome engine is running.

### **Q: Where Can I Get Spare Parts For My Motorhome?**

A: Retailers and service centre will be able to source most parts you require. For details of your nearest Elddis Retailer please refer to our Find A Retailer section on our website, or call 0371 964 2113 for assistance.

### **Q. How Many Years Will Spare Parts Be Available For My Motorhome?**

A. Elddis will endeavour to supply spare parts for a motorhome, for at least 8 years from new.

### **Q. Why Don't You Stock Parts At The Elddis Factory?**

A. Due to the volume of models we produce it is not possible for us to maintain stock levels of every individual component used in our manufacturing process. We do stock commonly requested items, but some items must be made to order

### **Q. What If The Parts Are No Longer Available?**

A. Where an original part is no longer available, whenever possible we will suggest a suitable alternative if it is available.

### **Q: Who Can Service My Motorhome Habitation?**

A: Your supplying Retailer is obliged to undertake your warranty work. However, any Elddis Approved / Service Centre can undertake the work, but this is at their discretion. We will also accept services completed by a NCC approved company, but they will not be able to undertake warranty work if they are not approved by Elddis.

### **Q. I Am Having Trouble Booking My Motorhome in For Its Service, In Line With The Requirements. What Timescale Is Acceptable?**

A. Please refer to the warranty section for the terms and conditions of servicing. We would recommend that you plan your services in advance in order to meet the requirements.



**Q. I Have A Problem With My motorhome, Who Can Help Me?**

A. We would always recommend that you contact your supplying Retailer. Your local Elddis Approved / Service Centre, NCC Approved Workshop or NCC equivalent standard as set out in this handbook may be able to assist. An inspection can then take place and the necessary course of action agreed.

**Q. I Am Unhappy With The Service I Have Received From My Retailer/Service Centre, Where Do I Go From Here?**

A. We would recommend that you write to your Retailer/Service Centre, detailing your problems and requirements, requesting a response explaining how they will resolve your complaint. A copy of your letter can also be forwarded to Elddis Customer Care Department, quoting the serial number of your motorhome and the name of the Retailer/Service Centre. Please be assured that we will assist your Retailer/Service Centre in resolving any problems.



## GLOSSARY

### **ABS - plastic**

Acrylonitrile Butadiene Styrene Plastic the material used for most of the large plastic components within your motorhome.

### **Actual Laden Weight**

This is the total weight of the motorhome when loaded ready for use by the end user.

### **Aquaroll**

Brand name used generically for a water container that rolls so you don't need to lift it.

### **Battery Charger**

This is required to keep a leisure battery charged. All motorhomes include a charging facility that operates via the mains hook-up, and also has the ability to trickle charge from the vehicles alternator while travelling.

### **Berth(s)**

Sleeping place - Refers to the number of people a motorhome can accommodate for sleeping.

### **Blown Air Heating**

A method of heating the living quarters of a motorhome by use of a fan pushing air out through a number of outlets.

### **Bunk Bed**

This is a sleeping place, usually higher up than a conventional bed. Often (but not always) this can be folded or removed to provide additional living space.

### **Propane**

Is a form of Liquefied Petroleum Gas (LPG) that normally comes in red cylinders. This type of gas is most commonly used in the UK.

### **Campingaz**

This is the trade name of Butane gas.

### **Cassette Blind**

This is a roller blind that is fitted as part of the window assembly, often along with a flyscreen, thus giving a neat installation.

### **Cassette Toilet**

A form of chemical toilet found in modern motorhomes, where the waste holding tank can be accessed and emptied from outside.

### **Control Panel**

Used as the description for the panel of electrical switches and gauges governing 12V and mains electricity systems.

### **Dinette**

This is a popular style of seating arrangement where two seats or settees face each other across a table.

### **Earth Leakage Circuit Breaker (ELCB)**

ELCB Earth leakage circuit breaker - see residual current device (RCD)

### **End Kitchen**

A common term used to describe floor plans that put the kitchen across the rear, usually adjacent to a motorhome door on one side and washroom on the other.

### **Essential Habitation Equipment**

Those items and fluids required for the safe and proper functioning of the equipment for habitation as defined by the manufacturer of the motorhome. This includes items such as the leisure battery and gas cylinders, plus water contained in the water heater etc.

### **Flyscreens**

Mesh fittings for windows doors and roof vents, to keep out insects etc.

### **Free-Standing Table**

This is a table that, because of its leg design, can be used inside or outside.

### **Full Service Pitch**

This is a pitch that has individual provision for fresh water supply and waste water disposal, in addition to mains electricity and in some cases TV aerial connection.

### **Gas Cylinder**

This is a portable, pressurised container for the storage of LPG.

### **Gas Cylinder Locker**

Is the compartment on the motorhome for the storage of gas cylinders.

### **Gas Drop out Holes**

These are not part of the ventilation. LPG is heavier than air, so holes through the floor below gaspowered appliances allow any leakage of gas to exit the habitation area.



## **Grey Water**

This is the waste water from sink/shower.

## **Gross Vehicle Weight (GVW)**

This is the weight of the vehicle laden to its maximum, as defined by the manufacturer. See also MTPLM.

## **GRP**

Is Glass-reinforced plastic, but more commonly known as glass fibre (not fibre glass, which is a trade name)

## **Handbook**

This is an owner's manual, a guide to the workings of your motorhome.

## **Hardstanding**

This is a pitch which has a hard surface made of gravel, asphalt, concrete etc, instead of grass.

## **Hook-Up**

This is a facility on a pitch for connection to mains electricity.

## **Ingress**

Usually meaning water ingress, a possible problem where water seeps in at the joins, usually as a result of worn sealant.

## **Jack**

This is a device for raising the vehicle so that a wheel can be changed.

## **Kerb Weight**

This is the empty weight of a motor vehicle as defined by the manufacturer.

## **Layout**

This is the Interior design and details where furniture units are placed in relation to each other.

## **Leisure Battery**

This supplies the power for the motorhome electrical systems and is sometimes called an auxiliary battery.

## **Levelling**

The process of ensuring that a motorhome is level when sited on a pitch. It is important for comfort and also to ensure the correct functioning of the fridge and water systems.

## **LPG**

Liquid Petroleum Gas, i.e. butane or propane.

## **L-Shaped**

This is a term where the seating area of a motorhome is indeed Lshaped.

## **Mains Hook-Up**

This is a site facility where you can plug into a mains electricity supply.

## **Maximum User Payload**

This is the maximum payload available for the user including essential habitational equipment.

## **MIRO - Mass In Running Order**

Weight of the motorhome equipped to the manufacturer's standard specification. Therefore the condition in which it leaves the factory. Note that this does not include any part of the user payload, including the essential habitation equipment.

## **MTPLM - Maximum Technically Permissible Laden Mass**

The technical maximum permissible laden weight of the motorhome, this must not be exceeded.

## **NCC (National Caravan Council)**

The only trade association representing manufacturers, retailers and suppliers within the motorhome industry.

## **Optional Equipment Payload**

The payload provided by Elddis for any factory fitted options that may be available.

## **Owners' Club**

This is a group of people who usually own the same brand of motorhome and enjoy meeting up for rallies.

## **Payload**

The amount you can put into a motorhome. Specifically the difference between the Maximum Technical Permissible Laden Mass (MTPLM) and the Mass In Running Order (MIRO).

## **PDI**

This is an inspection undertaken by the Retailer prior to handover to the customer.

**Pitch**

A designated area of a motorhome site allocated for the use of one outfit. Most sites will be arranged with defined pitches.

**Propane**

Gas used in colder conditions and is usually supplied in red cylinders.

**RCD**

This is a residual current device and is part of the electrical system that will 'trip' if there is an electrical fault.

**Gas Regulator**

Safety device fitted between the gas cylinder and the gas system of a motorhome, which controls the pressure of gas being released from the cylinder.

**Road Lights**

The external lights used while the vehicle is traveling.

**Roof Lights** - See Roof Vent.

**Roof Vent**

Is an opening unit in the ceiling that lets in ventilation and light, these vary in size, but the best ones will have integral blinds and flyscreens and are also called rooflights.

**Semi-Rigid Pipe work**

Is water pipes made of a semi rigid plastic and are infinitely preferable to cheaper convoluted piping which can act as a trap for germs and smells.

**Slats**

Sometimes used for beds and can improve ventilation to mattress cushions.

**Space Heater**

This is a type of heating equipment for the living quarters. Modern units fitted offer gas and mains-operation.

**Speed Rating**

This is the maximum speed at which a tyre may be used, as marked on its sidewall.

**SMMT**

Society of Motor Manufacturers and Traders.

**Torque Wrench**

A form of spanner used to set nuts and bolts to a specified degree of tightness. It is recommended for adjustment of wheel fixings on motorhomes.

**User Payload**

The weight of all items carried in the motorhome.

**U-Shaped Settee**

Usually a reference to seating that literally is 'U' shaped.

**Vehicle Kerb weight**

The weight of the tow car often indicated in the manufacturers specifications.

**VIN - Vehicle Identification Number**

This is a unique serial identification number for a vehicle. All cars and motorhomes should carry a VIN. Motorhomes are not obliged to, but most of those sold in recent years in the UK do.

**Warranty**

Are the terms and conditions that spell out your rights with regard to servicing, repair or replacement of parts as provided by the manufacturer.

**Wild Camping**

Term used for staying overnight away from a site. Illegal in many countries, but permission may be granted by individual landowners.





## MOTORHOME HABITATION ANNUAL SERVICE RECORD

In order to ensure your warranty remains valid an annual service must be carried out in accordance with the requirements of this handbook. You are responsible for any charges incurred for the service of your vehicle. If the annual service is performed by an authorised Elddis Approved Retailer / Service Centre or NCC Approved Workshop then Erwin Hymer Group UK Limited deems that the service has been performed correctly.

You may choose to have your annual service performed by an unauthorised repairer / service centre and if you do it will be your responsibility to ensure that the service meets our requirements.

We will ask you to provide a copy of the following documentation:

- Damp report
- Annual Habitation Service check list (to the minimum standard set out in this handbook)
- Invoice / dated service stamp

If the Annual Service has not been performed in accordance with the requirements in this handbook your warranty will be invalidated, however this will not affect your legal or statutory rights as a customer.

Elddis will not pay any unapproved Service Centre for the undertaking of any warranty work.

### Minimum service requirements

The service must be undertaken by suitably qualified personnel.

A full damp test check should be undertaken and damp readings recorded.

A service check must be performed to the minimum standards set out below.

### Annual Habitation Service check list

#### UNDERBODY

Item	Condition
Under slung tanks and pipes - check condition and security	
Body Attachment - check security of body to the chassis	

#### ELECTRICAL SYSTEMS

Item	Condition
Check the leisure battery is being charged from both the engine when running, or with a multi-tester (caravans) and the mains charger	
Leisure Battery (if fitted) - check condition of the battery & its compartment	
Interior lighting & equipment - check operation and fuse rating	
Awning light - check operation	
Wiring earths - check for defects on all ELV circuits (Visual)	
LV inlet plug & extension lead – check condition & resistance across pins	
Earth Bonding - visual inspection	



**ELECTRICAL SYSTEMS (continued)**

Item	Condition
RCD unit - check operation of RCD test button and operations of MCBs	
230V appliances - check operation	
3 pin plug - check condition	

**GAS SYSTEMS**

Item	Condition
Regulator and gas hose - check age performance and security	
Perform a gas pressure check	
LPG Tank (if fitted) - check security	
Flame failure devices - check operation	
Gas cylinder - check security	
Gas dispersal holes - check they are clear from obstructions.	

**APPLIANCES (check gas and electric operation)**

Item	Condition
Fridge - check operation from 12V, 230V & gas	
Hob - check operation	
Oven - check operation	
Grill and fan - check operation	
Water boiler – Check operation	
Heater - check operation and top up header tank with anti-freeze (where applicable), bleed as necessary	

**WATER SYSTEM**

Item	Condition
Water pump & pressure switch - check operation	
Taps and pipes - check operation	
Water filter housing - check for leaks & replace filter where necessary	
Water system - check for leaks	
Water Tanks (if fitted) - check security of all water tanks including underslung tanks.	
Toilet - check security, operation of flush pump and free from obstructions.	
Drain down the system when checks are complete.	





## VENTILATION

Item	Condition
Rooflights - check all are free from obstructions, cracks and have a free air flow	
Floor vents - remove protective cover and check they are clear from obstruction then refit covers	

## FIRE & SAFETY

Item	Condition
Smoke and carbon dioxide detectors - check for operation via the test buttons fitted, check battery condition.	
Fire Extinguisher (if fitted) - check it is still within date	
Fire Blanket (if fitted) - check it is still within date	
Habitation door operation	

## BODYWORK

Item	Condition
Doors and windows - check all catches are present and operating correctly.	
Blinds and flyscreens - check condition and operation	
Roof - check condition of roof.	
Cab seats - check condition of the seats and seats belts	
Floor - check condition of floor	
Furniture - check condition of the furniture	
Damp Test - undertake a damp test and record all readings taken.	
Lubricate all locks	



**ANNUAL HABITATION SERVICE RECORDS**

**ANNUAL SERVICE RECORD**

MOTORHOME MODEL .....

VEHICLE IDENTIFICATION NUMBER ..... YEAR .....

**1st SERVICE**

DATE:

RETAILERS STAMP:

I/We certify that an annual service has been carried out in accordance with the manufacturers' and NCC recommendations.

**2nd SERVICE**

DATE:

RETAILERS STAMP:

I/We certify that an annual service has been carried out in accordance with the manufacturers' and NCC recommendations.

**3rd SERVICE**

DATE:

RETAILERS STAMP:

I/We certify that an annual service has been carried out in accordance with the manufacturers' and NCC recommendations.

**4th SERVICE**

DATE:

RETAILERS STAMP:

I/We certify that an annual service has been carried out in accordance with the manufacturers' and NCC recommendations.

**5th SERVICE**

DATE:

RETAILERS STAMP:

I/We certify that an annual service has been carried out in accordance with the manufacturers' and NCC recommendations.

**6th SERVICE**

DATE:

RETAILERS STAMP:

I/We certify that an annual service has been carried out in accordance with the manufacturers' and NCC recommendations.



**7th SERVICE**

DATE:

RETAILERS STAMP:

I/We certify that an annual service has been carried out in accordance with the manufacturers' and NCC recommendations.

**8th SERVICE**

DATE:

RETAILERS STAMP:

I/We certify that an annual service has been carried out in accordance with the manufacturers' and NCC recommendations.

**9th SERVICE**

DATE:

RETAILERS STAMP:

I/We certify that an annual service has been carried out in accordance with the manufacturers' and NCC recommendations.

**10th SERVICE**

DATE:

RETAILERS STAMP:

I/We certify that an annual service has been carried out in accordance with the manufacturers' and NCC recommendations.

**11th SERVICE**

DATE:

RETAILERS STAMP:

I/We certify that an annual service has been carried out in accordance with the manufacturers' and NCC recommendations.

**12th SERVICE**

DATE:

RETAILERS STAMP:

I/We certify that an annual service has been carried out in accordance with the manufacturers' and NCC recommendations.

**13th SERVICE**

DATE:

RETAILERS STAMP:

I/We certify that an annual service has been carried out in accordance with the manufacturers' and NCC recommendations.

**14th SERVICE**

DATE:

RETAILERS STAMP:

I/We certify that an annual service has been carried out in accordance with the manufacturers' and NCC recommendations.



**15th SERVICE**

DATE:

RETAILERS STAMP:

I/We certify that an annual service has been carried out in accordance with the manufacturers' and NCC recommendations.

**16th SERVICE**

DATE:

RETAILERS STAMP:

I/We certify that an annual service has been carried out in accordance with the manufacturers' and NCC recommendations.

**17th SERVICE**

DATE:

RETAILERS STAMP:

I/We certify that an annual service has been carried out in accordance with the manufacturers' and NCC recommendations.

**18th SERVICE**

DATE:

RETAILERS STAMP:

I/We certify that an annual service has been carried out in accordance with the manufacturers' and NCC recommendations.

**19th SERVICE**

DATE:

RETAILERS STAMP:

I/We certify that an annual service has been carried out in accordance with the manufacturers' and NCC recommendations.

**20th SERVICE**

DATE:

RETAILERS STAMP:

I/We certify that an annual service has been carried out in accordance with the manufacturers' and NCC recommendations.

**21th SERVICE**

DATE:

RETAILERS STAMP:

I/We certify that an annual service has been carried out in accordance with the manufacturers' and NCC recommendations.

**22th SERVICE**

DATE:

RETAILERS STAMP:

I/We certify that an annual service has been carried out in accordance with the manufacturers' and NCC recommendations.



**NOTIFICATION OF CHANGE OF OWNERSHIP**

If you purchase this vehicle as a used vehicle it may be possible to transfer the unexpired term of the warranty cover (up to a maximum of six years commencing at the original date of purchase from new). Please refer to the warranty section of the handbook for terms and conditions.

Please complete the attached form and post it to us along with the following information:

- A copy of the V5 registration form
- A copy of the habitation service handbook displaying a complete and up to date service history, including service checklist and damp report.
- A cheque for £50 made payable to Erwin Hymer Group UK Limited.

Transfer of ownership must be made within the first three months of any change of legal ownership in order for the warranty cover to remain valid.

Erwin Hymer Group UK Limited Customer Care  
 Delves lane  
 Consett  
 County Durham  
 DH8 7PE  
 www.elddis.co.uk

This form is also available for you to print from our web site.

**NOTIFICATION OF CHANGE OF OWNERSHIP**

**Previous owner details** (if known):

Name: .....

Address: .....

.....

..... Post code: .....

Email: .....

**New owner details:**

Name: .....

Address: .....

.....

..... Post code: .....

Email: .....

Daytime telephone number: ..... Date of purchase: .....

**Details of Motorhome:**

Range: ..... Model: .....

Vehicle identification number (17 digits): .....

\* In order for you warranty to remain valid, your motorhome must have been serviced annually by an Approved Retailer / Service Centre, NCC Approved Workshop or NCC equivalent standard as set out in this handbook.

If you do not want to receive information about products and services from Elddis, please tick.





**NOTIFICATION OF CHANGE TO NAME AND ADDRESS**

In order that we can provide you with the very best level of service we ask that you keep us informed of any changes to your contact details.

Should your details change please complete the online form on our website, in our 'Customers' section. Alternatively, please complete the attached form and post to us:

Erwin Hymer Group UK Limited Customer Care  
Delves Lane  
Consett  
County Durham  
DH8 7PE  
www.elddis.co.uk

.....✂.....

**NOTIFICATION OF CHANGE TO NAME AND ADDRESS**

**Previous details:**

Name: .....

Address: .....

.....

..... Post code: .....

Email: .....

**New details:**

Name: .....

Address: .....

.....

..... Post code: .....

Daytime telephone number: ..... Date of purchase: .....

Email: .....

**Details of your Motorhome:**

Range: ..... Model: .....

Vehicle identification number (17 digits): .....

If you do not want to receive information about products and services from Elddis, please tick.







**A**

- Alarm system ..... 10-1
- Automatic Charging System ..... 8-2

**B**

- Battery Installation ..... 8-1
- Battery Maintenance ..... 8-1, 12-1
- Bed make up ..... 9-53
- Bicycle racks ..... 3-2
- Bulb Ratings ..... 8-3

**C**

- Caravan Construction -  
Main Components
- Windows ..... 14-1
- Care of your Motorhome ..... 11-1
- Charging System ..... 8-2
- Code of Practice
- Remedial Work ..... 13-3

**D**

- Door operation ..... 9-1
- Doors ..... 9-43

**E**

- Electrical System ..... 8-1
- Electricity ..... 6-1
- 12v Systems ..... 6-1
- Connecting To Mains Supply .. 6-1
- Disconnecting Mains Supply .. 6-2
- Generator/Charger ..... 6-1
- Mains Supply ..... 6-1
- Overseas Electrical
- Connection ..... 6-2
- Power Supply Charger ..... 6-1
- Entertainment System ..... 9-49

**G**

- Gas ..... 6-3
- Connection ..... 6-3
- Hoses ..... 6-5
- Regulator ..... 6-3
- Gas Regulator ..... 6-4
- Gas Safety Advice ..... 7-1
- Generators / Charger ..... 8-1
- Glossary ..... 17-1

**H**

- Heating System
- Alde ..... 9-21

**I**

- Insulation ..... 14-1

**L**

- Levelling ..... 5-1
- Loading ..... 3-1

**M**

- Mains Unit ..... 8-1
- Motorhome Construction -  
Main Components
- Solid Construction
- Body Shell ..... 14-1

**N**

- Notification of Change of  
Ownership ..... 19-1
- Notification of Change to  
name and address ..... 20-1

**R**

- RCD ..... 8-2
- Refrigerator (RM8551) ..... 9-11
- Rooflights ..... 9-41



**S**

Safety, general ..... 2-1  
Security ..... 10-1  
Service records ..... 18-4  
Site Regulations ..... 5-1  
Storage  
    Long Term & Winter ..... 12-1

**T**

Taps ..... 9-42  
Toilet  
    Thetford C260 ..... 9-44

**V**

Ventilation ..... 2-2

**W**

Water System ..... 6-5  
Wheel changing ..... 11-3  
Windows ..... 9-42  
Wiring diagram ..... 15-1