



Elddis

AUTOQUEST

MOTORCARAVAN

OWNERS
HANDBOOK

Issue 1



CONTENTS

WELCOME & INTRODUCTION 1-1

End Of Life Vehicle Directive	1-2
Explorer Group Technical Approvals	1-2

GENERAL SAFETY 2-1

Please Read Before Using Your New Motorhome	2-1
Proper And Safe Use Of Storage Areas In Motorhomes	2-2
Ventilation	2-2
High-Level Ventilation	2-2
Low-Level Ventilation	2-2
Ventilation in Separate Bedrooms	2-2
Gas Dispersal Holes	2-2
Fire Safety	2-3
Fire Extinguishers	2-3
In Case Of Fire	2-3
Fire Retardant Foams	2-3

PREPARING FOR THE ROAD 3-1

Motorhome Weights Explained	3-1
Mass in Running Order	3-1
Maximum Technically Permissible Laden Mass	3-1
User Payload	3-1
Loading	3-1
Roof Racks	3-1
Roof Loading	3-1
Before Moving Off	3-2
Pulling Off	3-3

MOTORHOME HANDLING 4-1

Speed Limits	4-1
Bicycle Racks	4-1

SITE ARRIVAL 5-1

Check Site Regulations	5-1
Selecting A Pitch	5-1
Lateral Levelling (Side To Side)	5-1
Leveller Jack	5-1
Ramp	5-1

GETTING STARTED 6-1

Electricity	6-1
Power Supply Charger	6-1
12v Systems	6-1
Generator/Charger	6-1
Electricity Mains Supply	6-1
Connecting To Mains Supply on Arrival at Site	6-1
Disconnecting Mains Supply	6-2
When Leaving Site	6-2
Overseas Electrical Connection	6-2
Gas Supply	6-2
Connection	6-3
Gas Regulator	6-3
High Pressure Gas Hoses	6-3
Water System	6-4
Filling Your Fresh Water Tank	6-4
Waste Water Tank	6-4
Draining Down Your Water System	6-4

GAS SAFETY ADVICE 7-1

Facts About LPG	7-1
Awning Spaces, LPG and Appliance Exhaust	7-1
LPG Gas Systems	7-1

ELECTRICAL SYSTEM 8-1

12v Power Supply	8-1
Battery Installation	8-1
Battery Maintenance	8-1
Generators / Charger	8-1
230v Power Supply	8-1
Mains Unit	8-1
Resetting The RCD	8-2
230V Mains Equipment	8-2
Typical Consumption Figures	8-2
Automatic Charging System	8-2
Maximum Bulb Ratings For Internal Lights	8-2



CONTENTS

HOW TO USE YOUR

MOTORHOMES EQUIPMENT 9-1

Avantgarde Electrical	
Control Panels	9-1
Gauge	9-1
Switches	9-1
Pump	9-1
Water	9-1
AUX/VEH	9-1
Indicator Lights	9-1
RUN	9-1
WASTE	9-1
Cooking Equipment	9-2
Gas Hob	9-2
Duplex Grill & Oven Autoquest	9-2
Using The Oven	9-3
Refrigerator Operation	9-4
Autoquest Fridge	9-4
Gas operation	9-4
230V Operation All Fridges	9-5
12V Operation All Fridges	9-5
Water Heater Operation	9-5
230V Operation	9-5
Gas operation	9-5
Electric Operation	9-6
Fan Operation	9-6
Battery Charger	9-6
Smoke Detector	9-6
Rooflights	9-7
The Heki 2	9-7
To Open To The Tilted Position	9-7
To Open In The Intermediate Position	9-7
To Open In The Ventilation Position	9-7
Closing The Blinds	9-7
Opening The Blinds	9-7
Standard MPK Rooflight	9-8
Door Flyscreen	9-8
Polyplastic Window Opening	9-8
Window Opening	9-8
Taps	9-8
Kitchen Taps	9-8
Operation	9-8
Washroom Taps and Showers	9-8
Operation	9-9
Exterior Doors Retainers	9-9
Internal Doors	9-9
Toilet / Washroom Doors	9-9
Other Internal Doors	9-9

Magnetic Catches	9-10
Sprung Hinges	9-10
TV Aerial	9-10
Status 315 Omni Directional Aerial (Where Fitted)	9-10
FM Radio Connections	9-10
Thetford Cassette Toilet	9-10
Rotatable Toilet	9-10
Preparing the Toilet for Use	9-10
Emptying the Toilet	9-11
Bench Toilet	9-11
Preparing the Toilet for Use	9-11
Emptying	9-12
How To Make Up Your Beds	9-14
Autoquest 100 – 130	9-14
Autoquest 120 – 140	9-15
Autoquest 145	9-16
Autoquest 180	9-17
Over Cab Double Bed	9-18

SECURITY 10-1

Motorhome Theft	10-1
Explorer Protect – Autowatch 650 Alarm System (Option)	10-1
Additional Security	10-1
Free Crime Prevention	10-1
Explorer Protect Autowatch 650 Motorhome Alarm (Option)	10-1
Basic Operation Arming the System	10-1
Disarming the System	10-1
Panic Alarm	10-2
Emergency Disarm	10-2
Silent Arm and Disarm	10-2
Sensors	10-2
Passive Infra Red Sensor	10-2
Enhanced Features Arming The System In "At Home" Mode	10-2
Arming the System in Test or Buzz Mode	10-2



CONTENTS

CARE OF YOUR MOTORHOME	11-1	EQUIPMENT LIST	16-1
Exterior Body Shell	11-1	ELECTRICAL DRAWINGS	17-1
Glass Fibre Reinforced Plastic (GRP)	11-1	TECHNICAL SPECIFICATIONS	18-1
Acrylic Windows	11-1	GENERAL QUESTIONS	19-1
Window Blinds & Flyscreens	11-1	GLOSSARY	20-1
ABS - Wheel Spats & Panels	11-1	ANNUAL HABITATION SERVICE RECORDS	21-1
Interior Walls	11-2	MOTORHOME RETAILER SPECIALS	22-1
Furniture	11-2		
Carpets, Upholstery & Curtains	11-2		
Washroom & Handbasin Fittings	11-2		
Shower Trays	11-2		
Water Systems	11-2		
Water Containers	11-2		
Internal Water Systems	11-3		
Truma Space Heater	11-3		
Thetford Toilet	11-3		
Changing A Wheel	11-4		
STORAGE	12-1		
Storage For Long Periods	12-1		
Motorhome Covers	12-2		
Power Drain	12-3		
WARRANTY	13-1		
3-Year Manufacturer's Warranty	13-1		
Parts Covered By This Warranty for Years 1 - 3	13-1		
Specific Exclusions for Years 2 & 3	13-1		
Conditions Attached To The Warranty	13-1		
Conditions Attached To The Warranty (Continued)	13-2		
CODE OF PRACTICE - WATER INGRESS	14-1		
The Code	14-1		
Conditions Attached To the Code	14-1		
Customer Obligation - Servicing	14-1		
Mains Electrics	14-2		
Spare Parts	14-2		
Remedial Work	14-2		
MOTORHOME CONSTRUCTION - MAIN COMPONENTS	15-1		
Body Shell	15-1		
Windows	15-1		



1-1 WELCOME AND INTRODUCTION

Thank you for choosing a motorhome manufactured by The Explorer Group.

Before you drive off, please familiarise yourself with the motorhome and read this owners' handbook. This will help you to obtain the maximum pleasure from your vehicle and avoid endangering yourself and others.

Additional information and detailed appliance instruction manuals are also contained in your Owner's Information Pack.

Your new Elddis motorhome has been designed as a recreational vehicle and is intended for recreational use only. It is not intended for business use or for permanent habitation. The Explorer Group accepts no liability if the motorhome is used for any purpose other than recreational/holiday use.

Please Note: All Explorer Group motorhomes are classified as Grade 2 and therefore meet with the thermal insulation and heat levels for specific climatic conditions as specified within the British and European Standard BS EN 1646 part 1.

By following the instructions provided in this handbook and maintaining your motorhome in a first class roadworthy condition, you are sure to have many years of carefree use. To ensure the very best quality and reliability all motorhome designs and new developments are rigorously tested. Therefore the Explorer Group Ltd will accept no liability or uphold the warranty if the motorhome is altered

or modified in such a way that would adversely affect the reliability.

IMPORTANT

The Explorer Group serial number of your motorhome should be quoted in all correspondence, it can be found stamped on a plate fixed next to the motorhome door. It is also found within the engine compartment marked in blue ink. Your motorhome serial number can also be found on the NCC certificate that can be found within your Owner's Information Pack.

There is also a Peugeot serial number on the chassis cab or pillar, which should be quoted in any communications with Peugeot.

Changing market and supply situations may prevent us from maintaining the exact specification details in this guide and we therefore reserve the right to alter specifications as materials and conditions demand and supply an alternative.

Enjoy your new motorhome.



End Of Life Vehicle Directive

Your new motorhome fully complies with the European Directive on the End of Life Vehicles. In order to obtain information on how to dispose of your motorhome at the end of its life please visit the Peugeot website. The Peugeot website contains full details on all Peugeot products together with details of their environmental and recycling policies. The site address is www.peugeot.co.uk.

Explorer Group Technical Approvals

All Explorer Group Motorhomes have been European commission Whole Vehicle Type approved via the Vehicle Certification Agency (VCA). In order to ensure your new motorhome is safe to use the Explorer Group are members of and have been inspected by the following bodies.

National Caravan Council (NCC) who operate a certification scheme to ensure compliance with the European safety standards for motorhomes.
National Inspection Council for Electrical Installation and Contracting (NICEIC) who carry out an annual inspection of the Explorer Group electrical installations within motorhomes.

The Council for Registered Gas Installers (CORGI) who carry out annual inspections to ensure that the gas installation installed by the Explorer Group fully comply with all relevant regulations and standards.

The Explorer Group is an ISO 9001:2000 approved manufacturer certified by SGS Limited

PLEASE NOTE

Explorer Group Motorcaravan model year.

The Explorer Group model year starts on the 1st September and runs to the 31st of August.





2-1 GENERAL SAFETY

Please Read Before Using Your New Motorhome

In order for you to get the most out of your new Explorer Group motorhome it is necessary for you to be aware of the following:

- (i) Do not obstruct ventilators (See Safety Section - Ventilation)
- (ii) Inspect the flexible gas hose regularly for deterioration and renew as necessary, with approved type, as and in any case no later than the expiry date stated on the hose.
- (iii) It is recommended that you provide a dry powder fire extinguisher complying with ISO 7165 of at least 1KG capacity by the exit door and a fire blanket next to the cooker. Ensure you read the 'advice to occupier label' fitted to your motorhome.
- (iv) Never use portable cooking or heating equipment inside your motorhome. Do not use your fitted cooking equipment as heating at any time.
- (v) Never allow modification to your gas or electrical system unless qualified persons carry them out.
A CORGI registered gas fitter should carry out all modification to the gas system. Any modifications carried out on the electrical system should be carried out by an electrician on the roll of the NICEIC or be a member of the ECA.
- (vi) Never exceed your motorhome's Maximum Technical Permissible Laden Mass.

- (vii) Never exceed the front or rear axle maximum load as specified by the Peugeot weight plate under the bonnet.
- (viii) Please ensure extra care when young children use high level bunks and always use the safety net provided.
- (ix) Turn off all gas appliances and turn off the gas supply before driving your motorhome.
- (x) Do not leave children under 14 years of age unattended in your motorhome.
- (xi) Ensure the main gas tap is in the off position before setting off on any journey.
- (xii) Only those seats designated for travelling should be occupied when the motorhome is in motion.
- (xiii) Please note that motorhomes are covered by the new seat belt regulations, which came into force in October 2006. These require children that are under 12 years old and also under 135cm in height to be seated in either child seats or on bolster cushions.
- (xvi) Before travelling in your Motorhome
 - A. Ensure all the tables have been stored in their designated table storage position.
 - B. Ensure that the water heater cowl cover has been secured onto the external vent.

Proper And Safe Use Of Storage Areas In Motorhomes

The storage areas provided in your motorhome are designed solely for the purpose of carrying personal possessions; these areas must not be used:

- As a habitation area (e.g. living, sleeping or cooking)
- To carry passengers, animals or livestock
- For the installation (or use) of any LPG gas operated appliances, (unless supplied fitted by the manufacturer)
- For carrying LPG gas bottle cylinders, (unless designated by the manufacturer)
- (To carry any flammable liquids, (unless properly stored, sealed and secured)
- For the operation of an electrical generator
- In such a way that the loading exceeds the payload limit, as defined by the manufacturer
- Such that the weight distribution of the vehicle means non-compliance with the vehicle axle loads

Care must be taken to ensure that exterior doors are closed, locked and that all possessions are properly stored and secured before setting off on any journey.

Ventilation

All motorhomes manufactured by The Explorer Group are ventilated at both high and low level in accordance with BS EN 721 Safety Ventilation. The fixed ventilation points fitted in your motorhome must not be blocked under any circumstances as your safety may depend upon them. It is advisable that the fixed ventilation points are checked and cleaned (where necessary) on a regular basis.

High-Level Ventilation

This is always provided by fixed ventilation within the fitted roof skylight. All roof skylights fitted by Explorer Group provide fixed free area ventilation. These roof skylights should be cleaned annually by use of a small brush to remove any dust that may have accumulated around the mesh fitted. On some roof skylights the mesh can be easily removed to aid cleaning. On fan-assisted roof skylights it is essential that the fan is switched off prior to cleaning

Low-Level Ventilation

The vents built into the step by the main entrance door provide low-level ventilation. These vents should be kept clear and cleaned regularly using soapy water.

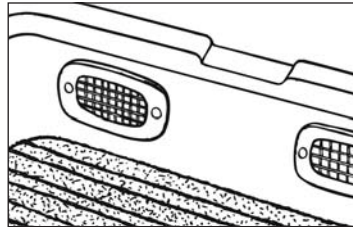

Ventilation in Separate Bedrooms

In motorhomes with separated sleeping areas, separate ventilation is required and is provided via a roof skylight at high level and a ventilator at low level within a bed box.

Gas Dispersal Holes

All appliances and gas unions have a gas dispersal hole nearby. It is essential that these are not blocked or made ineffective.



Fire Safety

Fire Extinguishers

It is recommended that a 1 kg (2lb) minimum capacity dry powder fire extinguisher be carried inside your motorhome at all times. Fat pan fire must not have an extinguisher aimed at it, but must be smothered with a fire blanket.

In Case Of Fire

- (i) Get everyone out of the motorhome as quickly as possible using whichever exit is quickest including windows. Do not stop to collect any personal items.
- (ii) Raise the alarm. Call the fire brigade.
- (iii) Turn off gas container valve if safe to do so.

Fire Retardant Foams

Under the requirements of the Consumer Protection Act 1987, the manufacturer has a responsibility to ensure that their product is as safe as possible. With this in mind all motorhomes are equipped with either Combustion Modified High Resilient (CMHR) foam cushions or sprung mattresses. These foams are very much safer from a fire point of view than those previously used. In addition all upholstery is made of fire retardant fabric.

3-1 PREPARING FOR THE ROAD

Before venturing out on to the road with your motorhome, it is important that you prepare correctly.

Your Motorhome (Weights Explained)

Mass In Running Order

The weight of your motorhome as it leaves the factory, as new with standard fixtures and fittings, plus an allowance for the driver of 75kgs and the mass of the fuel when the tank is full, 90% of the water carried in the water tank and an allowance for the gas bottles.

Maximum Technically Permissible Laden Mass

The maximum mass the vehicle can be when fully laden for use on the road.

User Payload

The load margin (payload), this represents the difference between the Mass in Running Order and the Maximum Technically Permissible Laden Mass. It shows the maximum weight that can be loaded into your motorhome, covering items such as food, crockery, cutlery, clothing, bedding, etc.

Loading

It should be noted that even weight distribution is a major factor in making your motorhome an easy and pleasant vehicle to drive. Care should therefore be taken in balancing the load, ensuring that heavy items are well spaced and are in as low a position as possible, for example, low cupboards and bed boxes.

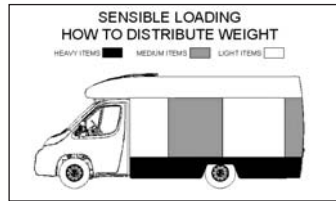

IMPORTANT

Do not exceed recommended maximum loading for your motorhome.

Roof Racks

Some models of Motorhomes have, available as an option, a roof rack and ladder. Care is needed when using this facility. We recommend you exercise extreme caution when loading and unloading.

CAUTION

Do not allow children to climb onto the roof. Do not exceed the stated maximum load. Items fitted other than standard equipment will deplete the payload stated in this handbook.

Roof Loading

All motorhomes have a specially designed roof rack system available as an optional extra. The roof of each motorhome is strengthened to accommodate the roof rack, however, the strengthened area only relates to that contained within the roof rack area, and to step beyond this area may cause damage to the roof.

Please Note: The roof rack is capable of withstanding a maximum weight of 12 stone/76kgs.

Static roof loading or top box loading should be limited to a maximum of 76kgs including contents, or the limit set by the top box manufacturer, which ever is the lower figure.



Before venturing out on to the road with your Motorhome, it is important that you prepare correctly.

WARNING

Under NO circumstances walk on the over cab roof section

Roof loads should be evenly distributed and securely fastened, but care must be taken not to over-tighten straps or ropes to the point where roof rails or brackets may become distorted, particularly as during braking and cornering, forces exerted by straps or ropes are greatly increased.

It is also worth noting that when carrying heavy or large objects on the roof, the vehicles handling may change due to the resultant displacement of the centre of gravity and the increased area exposed to the wind.

BEFORE MOVING OFF

Whenever making a journey with your motorhome, either setting off on holiday or returning home, it is good practice to run through this simple checklist.

- (i) Close and secure all cupboards and drawers and check for any loose articles.
- (ii) Do not store tins, bottles, etc. in overhead lockers.
- (iii) Close and secure all windows and roof lights.
- (iv) Leave all curtains and blinds open to aid visibility.
- (v) Check that gas cylinders are securely fastened and that the valve on the gas cylinder is turned off. Also ensure that the gas locker door is securely fastened.
- (vi) Turn off all gas appliances.
- (vii) Switch off 240volt supply at source, disconnect mains cable and store in an appropriate place.
- (viii) Check that the battery is secure and that the battery box lid is fastened.
- (ix) Ensure the fridge is on 12V operation and door lock is set. (Note: the electrical relays will allow the fridge to be run on the vehicle battery when the engine is running.)
- (x) Remove any external fresh water connections etc.
- (xi) Make sure any heavy articles are stored in accordance with the loading procedure. Tables should also be made secure.
- (xii) Lock the motorhome exterior door (remember to take out your keys).
- (xiii) Check your external rear view mirrors and adjust if necessary.
- (xiv) If a step is used, ensure it is put away before moving off.
- (xv) Your new Explorer Group motorhome has been designed to carry passengers in designated passenger seats only. The fitting of a 3-point seat belt can identify these seats. Any seat not fitted with a 3-point seat belt is not designated as a passenger seat.
- (xvi) You are strongly recommended not to carry passengers unless they are seated in a designated passenger seat.
- (xvii) Check that the water heater cowl cap has been secured on the external vent.



FOR SAFETY

- (i) **Ensure all the tables have been stored in their designated table storage position.**
- (ii) **Ensure that the water heater cowl cover has been secured onto the external vent.**

Pulling Off

- Engage the clutch smoothly.
- Avoid wear and tear on clutch and transmission by taking extra care.
- Change gears smoothly.
- Try not to jerk the clutch.

4-1 MOTORHOME HANDLING

- Do not bump kerb with wheels.
- When passing other vehicles allow more than the normal clearance.
- Allow longer to get up speed to pass. Do not suddenly swing out.
- Carry out all manouvres as smoothly as possible.
- Use the nearside wing mirror to check motorhome has cleared when overtaking.
- Slow down and take care when over raised speed bumps, 'sleeping policemen' or when embarking/ disembarking ferries.
- In high or cross winds, traveling downhill or in conditions of poor visibility reduce your speed.
- High-sided vehicles can cause air buffeting so extra care must be taken when passing or being passed. Leave as much space as possible when overtaking these types of vehicles.

Speed Limits

Be sure to observe all statutory speed limits and adapt your speed to take account of prevailing weather and road conditions.

WARNING:

Ensure the wheel is of the same construction and size as the one that has been removed.



Bicycle Racks

Fitting a bicycle rack to the rear panel of a motorhome will affect how weight is distributed. There are restraints to be aware of with such fitments.

We would advise you to carry a maximum of 75kgs on the bicycle rack provided this does not exceed the bicycle racks own weight limit. The motorhome must also be balanced to take into account the new weight distribution. Weight must be distributed evenly. Bicycle racks are not standard fit or supplied as an optional extra by the Explorer Group. Explorer cannot be held responsible for problems related to a bicycle rack fitted by a third party. A copy of the rear panel drawing must be obtained from The Explorer Group to ensure correct fixing points are located.

5-1 SITE ARRIVAL

Check Site Regulations

On arrival at a campsite, you should always check the site regulations. This will help avoid any unnecessary conflict with site management and other site users.

Selecting A Pitch

Carefully select where you wish to place your motorhome. The site should be as level as possible, preferably not under or near trees, well drained and away from possible boggy areas. Consider how you will move the motorhome when it is time to leave the site. On sloping ground it is better to pitch facing downhill, especially during wet weather.

Lateral Leveling (Side To Side)

A quick glance at your pitch should tell you if you are likely to need side to side leveling i.e. leveling across the axle. On uneven ground lateral leveling is accomplished by the use of a leveler jack or ramp and a spirit level placed 'across' the motorhome floor.

Leveler Jack - Place the leveler jack, folded flat, in front of the wheel needing to be raised to level the axle. Drive the motorhome onto the leveler jack and adjust the height until the spirit level shows that the motorhome is laterally level.

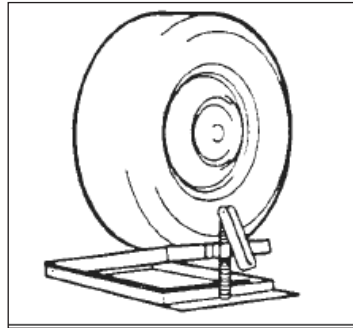

Ramp - Reverse onto your pitch about a foot further back than you wish to end up. Then place the leveling ramp in front of the wheel that needs to be raised.

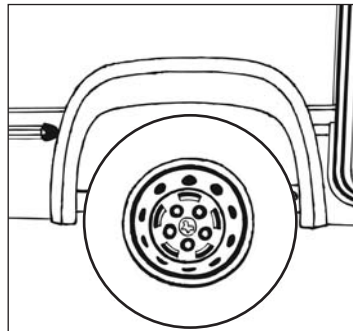

Place a spirit level parallel to the axle or just inside the motorhome door. It helps to have two people at this point. One should drive the motorhome very slowly forward moving the wheel up the ramp, and the other should indicate when the spirit level bubble is in the middle. Whichever method you use, once level, apply the motorhome handbrake and chock the motorhome wheel if necessary.

6-1 GETTING STARTED

You have arrived at your destination and now want to start to enjoy your new Explorer Group motorhome. The following is a step-by-step guide to connecting your services and getting everything in your motorhome working.

Electricity

Power Supply Charger

Your motorhome is fitted with a power supply/charger. This will charge the motorhome leisure battery when fitted and also power the 12V systems in your motorhome. It is recommended that you always carry a leisure battery. The Charger is fully automatic and will not overcharge the leisure battery.

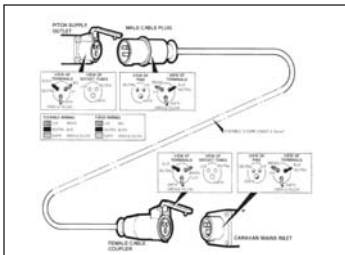
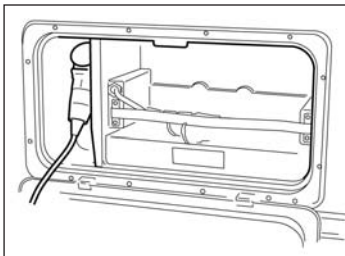

12v Systems:

Your motorhome is fitted with an automatic system for selection of power. When connected to the 230V site supply the automatic Power Supply/Charger will charge the leisure battery and power the 12V systems. When the ignition is switched on the 12V system in the motorhome is automatically switched off, car power is supplied to the refrigerator and battery charging is in operation.

Generator/Charger:

When connecting to a generator, always switch off the RCD, start the generator and allow running for a few minutes to stabilise. When this has happened, switch the RCD to the ON position.

Electricity Mains Supply

Your motorhomes main electrical installation is designed to run on 230V at 50 hertz AC supply.

Connecting To Mains Supply on Arrival at Site

Before connecting the motorhome installation to the mains supply, check that:

- (i) The mains supply is suitable for your installation and appliances, i.e. whether it is AC or DC and whether it is at the correct Voltage and frequency.
- (ii) Your motorhome is properly earthed. Never accept a supply from a socket outlet or plug having only two pins, or from a lighting outlet.
- (iii) Any residual current device (earth leakage circuit breaker) in the mains supply to the motorhome has been tested within the last month. In case of doubt, consult the site owner or their agent.



- (iv) Make sure that the switch at the site supply point is off and that all electrical equipment in the motorhome is switched off by ensuring your motorhome mains isolating switch on the MCB is in the 'OFF' position.
- (v) Once the above checks have been made remove any cover to the electricity inlet provided on the motorhome, and insert the female connector of the flexible orange supply cable as shown.
- (vi) Locate the site supply and remove any cover from the socket outlet provided at the supply point. Insert the male plug at the other end of the flexible orange supply cable. Switch on the main switch at the site supply point (if appropriate).
- (vii) Place any surplus cable under the motorhome. Ensure that the surplus cable is not coiled up as it could overheat.
- (viii) The MCB main electricity supply switch should be put in the 'ON' position.
- (ix) Check the RCD is working by pressing the test button. Once pressed all electrical lights and appliances should cease to operate. Reset, and then check the electrical system is operational.
- (x) Finally in order to get your 12V system operational, ensure the master 12V switch is in the on position.

Disconnecting Mains Supply When Leaving Site

- (i) Switch 'OFF' at the motorhome mains isolating switch.
- (ii) Remove the male plug from the site supply.
- (iii) Disconnect the female plug from the motorhome and store the cable in an appropriate locker.

Overseas Electrical Connection

Please Note: Connection to a mains Voltage supply OVERSEAS requires particular attention. Care must be taken when connecting supplies abroad since the supplies can be of REVERSE POLARITY.

The significance of REVERSE POLARITY is that when equipment is switched off, it may not be electrically isolated. The only certain way of making equipment safe is to unplug it.

A means of checking the polarity of the mains supply when overseas is recommended. There are available several proprietary makes of equipment for the purpose.

If it can be achieved, it is preferable to connect live to live, and neutral to neutral to maintain full electrical protection.

CHECK all motorhome equipment is set-up to accept the site supply before actually switching on.

Gas Supply

Your motorhome is designed to operate using either propane or butane liquified petroleum gas at 30M/bar. Gas can be obtained from your motorhome dealer. Your motorhome is designed to accept a maximum of 2 x 6kg Calor Lite propane cylinders available from motorhome dealers and Calor gas retailers for further information please visit www.calorlite.co.uk

Connection

Make sure that heating and cooking appliances and gas cylinders are switched off.

Each gas appliance is connected to its own gas isolation tap. These are identified on the tap via a label. Below is a key to identify each label. To operate the tap the arrow on the tap shows the direction of flow for the gas. The arrow should be pointing towards the appliance for the appliance to operate. There will be a small label next to the bank of taps under the cooker, which is also reproduced to the right:



Water Heater



Space Heater



Refrigerator



Cooking Appliance



Hob

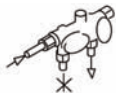

Gas On/Off

Gas Regulator

Your new Explorer Group motorhome has been fitted with a fully approved gas regulator designed to operate at a gas pressure of 30Mbar. Your regulator is fitted with a test point, which is accessed via the inlet at the

side of the regulator. This access point is only for carrying out gas pressure tests and should not be used for any other purpose.

CAUTION

It is strongly recommended that only CORGI approved gas fitters carry out any work on your motorhomes gas installation.

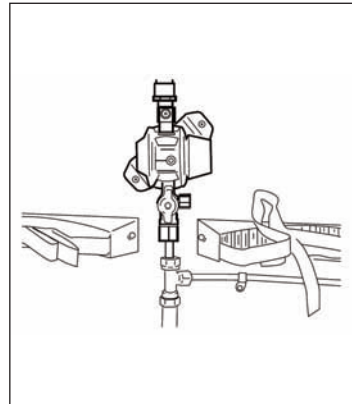

High Pressure Gas Hoses

You should only connect to this regulator using an approved high-pressure hose of length not exceeding 450mm from the gas cylinder to the regulator. These approved high-pressure hoses are available from your Explorer Group Retailer. These hoses are connected using screw thread fittings, which will make a seal if connected and tightened using a spanner. Once the hose is securely connected turn on the gas tap above the regulator, then turn on the gas bottle to allow gas to flow into the motorhome.

In order to make all your motorhomes gas appliances operational it is necessary to open each appliance gas tap as detailed in 6.1. All your gas appliances should



now be operational. Instructions on how to use each appliance are detailed later in your handbook.

WARNING

Aerosols and highly flammable liquids must not be stored in the compartment behind, or adjacent to, any gas appliance. Some industrial LPG appliances operate at high pressure and require a 'high pressure' regulator. This often has an adjusting handle on it. NEVER use such a regulator on a motorhome.

Ventilation holes must be clear at all times.

Water System

Filling Your Fresh Water Tank

Your new Explorer Group motorhome will be fitted with a 45litre fresh water tank. In order to fill the water tank firstly remove the water filler cap identified by a blue label then the tank can be filled using both the 12v power supply and the pump provided in your kit box or by using a direct hose pipe. Please not take care not to over fill your tank it is advised that someone monitors the water level in the tank while filling is in progress.

Waste Water Tank

Your new Explorer Group motorhome is also fitted with a 45litre waste water tank all waste water excluding the toilet waste will run into the waste water tank. The level of water in the tank can be monitored using the control panel. Opening the grey waste outlet provided on the outside of the motorhome empties the tank. Open the tap when the outlet is over a drain and the water will run out of the tank.

Draining Down Your Water System

- (i) It is essential that you drain down your motorhome water system when it is not in use. This is most important during winter months to protect against frost damage
- (ii) Disconnect the water pump and switch off power supply.
- (iii) Remove the water heater fuse from the switch spur and store in a safe place.
- (iv) Open the safety drain valve on the water heater located next to the water heater.
- (v) Open all taps and remove all plugs from sinks and showers. Lever operated taps should have the lever put into the up and central position.
- (vi) Open both the blue and grey drain outlets on the outside of your motorhome.
- (vii) Adjust the level of the motorhome to ensure that the drain outlet is at the lowest point of the motorhome. This will aid the flow of water to ensure all water is drained off.

After 30 minutes level the motorhome and prepare it for storage if necessary.



7-1 GAS SAFETY ADVICE

In the event of a suspected gas leak the gas must be turned off using the isolation valve on the gas bottle. A competent gas fitter should then check the system before it is used / reused.

Regularly check flexible gas hose, joints and connections for tightness. Finally, make sure that each gas appliance is working efficiently to the recommendations of the appliance manufacturers.

(See Index – Ventilation)

1 Facts about LPG

- LPG is not poisonous.
- Bi-products are harmless.
- LPG is dangerous if all air and oxygen is excluded.
- LPG has been given a smell by the manufacturer in order to identify leaks.
- The gas is heavier than air and therefore sinks to the lowest point.

2 Awning Spaces, LPG and Appliance Exhaust

There is no danger of pollution of an enclosed awning space from the LPG exhaust from a refrigerator venting into it. Space heaters may produce sufficient exhaust to pollute the awning space, if it is totally enclosed, from a general comfort, smell and hygiene point of view. In extreme cases there could be a build up of carbon dioxide to a dangerous level. Motorhome owners are advised to allow some fresh air circulation in the awning space when such appliances are in use.

Please Note: Ventilation holes must be clear at all times.

3 LPG Gas Systems

The Explorer Group does not recommend the use of any external cylinders. All cylinders in use should be within the gas locker provided. If you wish to utilise a larger cylinder and have this outside the gas locker then the connecting hose must not exceed 750mm.

It is recommended that no flammable material is stored or placed within 300mm of any open flame. Your attention is also drawn to the fact that the surface of the space heater in your motorhome will get hot when in use. You are advised not to use any additional gas appliances outside your motorhome unless it is a gas barbecue connected via the barbecue point supplied with your motorhome.

Please ensure that you have read the operating instructions for each gas appliance contained in your Owners Information Pack. Please ensure that any gas hose left unconnected is protected from dirt or other foreign bodies entering the hose.



8-1 ELECTRICAL SYSTEM

12v Power Supply

Battery Installation

Your motorhome will be fitted with a BCA Leisure.

If you wish to install a leisure battery please ensure that it is placed on the battery tray supplied with your motorhome. Then place the tray in the battery locker fitted to the side of your motorhome. Connect the battery to the clamp fittings connected to the connection leads within the battery box.

The Explorer Group recommends that you use sealed for life leisure batteries of a minimum rating of 40 ampere-hours at 20 hours discharge rate.

Battery Maintenance

Your leisure battery should be maintained in accordance with the manufacturer's instructions.

For information on the automatic charging system in your motorhome please refer to 'Automatic Charging System' in the index.

Do not charge your leisure battery with any charger other than that supplied. Failure to comply may cause damage to your battery.

If you remove your leisure battery, ensure that it is not placed on a cold surface as the battery will deteriorate more rapidly than if stored at a suitable temperature

Generators / Charger

All electrical equipment fitted in your new motorhome can be run from either a controlled generator or charger whose output is maintained between 11volts and 14volts.

At least once every 3 years, the motorhome electrical installation should be inspected and tested, and a report on its condition obtained, as prescribed in British Standard BS7671.

230v Power Supply

Mains Unit

The Mains Unit replaces the conventional fuse box. Similar, but larger ones are often fitted in new houses. The unit, which can be found in the nearside front bed box, gives overloads and earth leakage protection for the 230V electrical supply in your motorhome.

For normal operation all switches on the unit need to be in the ON position. The switches on the left of the unit are known as MCB's (miniature circuit breakers). These take the place of the conventional fuse but are more convenient. In the event of a fault the MCB 'trips' i.e. automatically moves to the OFF position. After elimination of the fault the MCB can be re-set by switching to the ON position (against the spring pressure in an upwards direction). If an earth fault develops, or a person was to touch a live piece of equipment, the leakage of current to earth should immediately operate the RCD (residual current device) and 'trip' the main switch, to the OFF position. This switch can only be re-set after elimination of the fault.

Please Note: In case of difficulty, consult an approved electrical installation contractor (who may be the local electricity board). It is dangerous to attempt modifications and additions yourself.



CAUTION

Lamp holder-plugs (bayonet- cap adaptors) should not be used under any circumstances.

Resetting the RCD

To re-set, operate the switch as for MCB's. Periodically, the RCD should be checked by operating the test button marked 'T'. The unit should immediately switch to the OFF position. If the unit does not switch off then a qualified electrician should be consulted. If the unit does switch off, the test is complete and the switch can be re-set restoring the supply back to normal.

Please Note: Simultaneous operation of all of the 230V mains electrical equipment may not be possible. A typical UK site mains hook-up point provides a maximum output of 16 amps and on some continental sites the available output may be as low as 5 amps.

If your loading exceeds the site supply it may trip the site circuit breaker. Please check the available mains output with your site operator. The following items need to be added together if used simultaneously.

230V Mains Equipment Typical Consumption Figures:

- Refrigerator 0.50 amps
- Charger 0.50 amps
- Water heater 3.9 amps
- Blown air heaters 8.5 amps
- Colour TV 2.50 amps

Automatic Charging System

The battery charger will operate automatically when the motorhome is connected to the mains outlet on a motorhome site. The 12V system, with the exception of the 12V refrigerator and battery charging, will not operate when the motorhome is connected to the driving vehicle.

CHECK all motorhome equipment is set-up to accept the site supply before actually switching on.

Maximum Bulb Ratings for Internal Lights

Type of Light	Maximum Bulb Rating
12V Fluorescent Lumo	9 watt
12V Fluorescent Crown	9 watt
12V Zoe eyeball Lights	10 watt
12V Nova Halogen	
Downlighter	10 watt
230V Wall lights	20 watt

Please Note: Ensure that you only replace a blown bulb with one of the same rating. Never replace a bulb with one with a higher rating. You should ensure that when fitted, no bulb is in contact with the surface of the lamp or shade.

9-1 HOW TO USE YOUR MOTORHOMES EQUIPMENT

Within this section of your motorhomes handbook we will give you brief details on how to operate all of the motorhomes equipment from the gas cooking equipment to the window blinds. For further details on the major equipment within your motorhome please read the individual appliance instructions contained with your user information pack.

Please Note: Before attempting to use any gas equipment please ensure that the gas bottle is connected securely to the motorhomes regulator via a high pressure gas hose and the bottle valve is in the on position. Also ensure the appliance isolation valves are in the on position as shown in the gas system section.

Please Note: Before attempting to use any electrical appliance please ensure that you have connected the mains connection cable to a mains hook up and that the mains isolation switch is in the on position. Ensure the 12V Master switch is in the on position this is found in the side of the unit next to the entrance door.

Electrical Control Panel

The control panel consists of a gauge, three switches and two indicator lights.

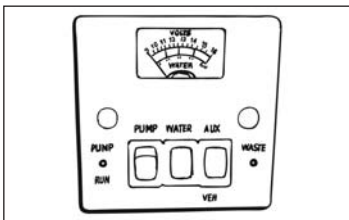

Gauge

The gauge will normally show the voltage in the vehicle or auxiliary battery depending on the position of the AUX/VEH change over switch. The gauge can also show the water level in the inboard water tank (see Water Switch).

Switches

The three switches are;

Pump

The Pump switch acts as a master switch for the internal water system. When the switch is on the internal water pump will provide water for the sink taps. Should the pump keep cutting in and out during the night, then turning the pump switch off will disconnect the 12-volt supply to the pump.

As the external pump works independently of the pump switch, this can still be used with the pump switch in the off position.

Water

Pressing and holding the 'Water' switch will cause the gauge to show the water level in the fresh water tank. Releasing the switch causes the gauge to return to showing the voltage.

AUX/VEH

When the switch is in the 'VEH' position the motorhome 12-volt system is powered from the vehicle battery. When it is in the 'Aux' position it is powered from the motorhomes auxiliary battery or the 12-volt charger/power supply if the motorhome is connected to a 230-volt supply.

It is recommended that the motorhome be used in the 'VEH' position sparingly as prolonged use without running the engine can flatten the vehicle battery.

Indicator Lights

There are two indicator lights on the control panel;

RUN

This is the green indicator light. When the pump switch is on and the pump is running this light should be on. When the pump is not running the light should not be on.

Please Note: This indicator only works with the internal pump.

WASTE

This is the red indicator light. When the onboard waste tank is becoming full and requires emptying this light will come on. Once the tank is empty the light will go out.

Cooking Equipment

WARNINGS

- (i) All pans should be mounted centrally over the burners, even when cooling, to protect adjacent walls.
- (ii) Do not lower the glass cover until hob has cooled down.
- (iii) Glass lids may shatter when heated. Turn off all burners and grill before shutting the lid. The glass cover should be raised when operating the grill.
- (iv) Accessible parts may be hot when the grill and oven are in use. Young children should be kept away.
- (v) Do not use grill or oven as a space heater.

Gas Hob

- (i) Turn the individual gas tap for the burner you wish to light.
- (ii) Depress the ignition button, which can be found on the

front of the oven next to the oven control, while depressing the gas tap.

The depressing of the gas tap overrides the flame failure device fitted to the burner. If the burner fails to light within 20 seconds then release the gas tap and wait 30 seconds before trying again.

- (iii) Once the burner lights it will be necessary to keep the tap depressed for about 5 to 10 seconds to ensure that the flame failure device is heated up enough to operate.

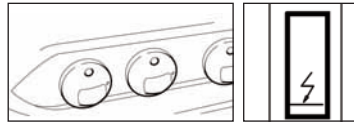

Burner controls

Ignitor button

Duplex Grill and Oven

- (i) Ensure gas cylinder/supply is connected and turned on. In the event of a gas smell turn off at gas cylinder/mains and contact supplier.
- (ii) To light the grill open door, push in the control knob and turn to full rate. The burner can be ignited by depressing the ignition button, which is located on the fascia. Ignition must be carried out with the door open, and if the burner has not lit within 15 seconds the control knob should be released and the grill left for at least 1 minute before a further attempt to ignite the burner.
- (iii) On first use of the grill, it should be heated for about 20 minutes to eliminate any residual factory lubricants that might impart unpleasant smells to the food being cooked.



A non-toxic smoke may occur when using for the first time so open any windows and turn on mechanical ventilators to help remove the smoke.

- (iv) Although the grill does heat up quickly, it is recommended that a few minutes preheat be allowed.

IMPORTANT

The grill **MUST** only be used with the door open.

The heat deflector below the fascia should be pulled out prior to lighting the grill. Never adjust the heat deflector position without using hand protection – i.e. oven gloves.

- (v) Flame Failure Device (FFD): the grill burner is fitted with a flame sensing probe, which will automatically cut off the gas supply in the event of the flame going out. In the event of the burner flames being accidentally extinguished, turn off the burner control and do not attempt to re-ignite the burner for at least one minute.
- (vi) It is normal for the flames on this burner to develop yellow tips as it heats up, particularly on Butane.
- (vii) A reversible grill pan trivet enables the correct grilling height to be achieved. Fast Toasting trivet in high position. Grilling Sausages trivet in high position. Grilling Steak/Bacon trivet in high position. Grilling Chops, etc trivet in low position.
- (viii) Slow Grilling trivet removed To turn off: turn the control knob until the line on the control knob is aligned with the dot on the control panel. Always make sure the control knob is in the off position when you have finished grilling.

Using The Oven

- (i) Ensure gas cylinder/supply is connected and turned on. In the event of a gas smell turn off at gas cylinder/mains and contact supplier.
- (ii) To light the oven open door, push in the control knob and turn to gas mark 9. The burner can be ignited by depressing the ignition button, which is located on the fascia. Ignition must be carried out with the door open, and if the burner has not lit within 15 seconds the control knob should be released and the oven left for at least 1 minute before a further attempt to ignite the burner.
- (iii) Place the oven shelf in the required position and close the door. Set control knob to approximately gas mark 5 and heat the oven for about 30 minutes to eliminate any residual factory lubricants that might impart unpleasant smells to the meals being cooked. A non-toxic smoke may occur when using for the first time so open any windows and turn on mechanical ventilators to help remove the smoke.
- (iv) Although the oven does heat up quickly, it is recommended that a 10 minutes preheat be allowed. The oven should be up to full temperature in about 15-20mins.
- (v) To turn off: turn the control knob until the line on the control knob is aligned with the dot on the control panel.

- (vi) The shelf has been designed to allow good circulation at the rear of the oven and are also fitted with a raised bar to prevent trays or dishes making contact with the back of the oven. To remove a shelf, pull forward until it stops, raise at front and remove.

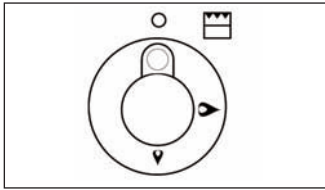

IMPORTANT

The pan supplied with the appliance is multi functional, for use either whilst grilling or when using the oven. The handle design allows removal or insertion whilst the pan is in use. Always remove the handle when the pan is in use.

Midi Prima Gas Oven (Option)

- (i) Turn the gas oven control knob to maximum then depress the knob while pressing the electronic ignitor button. If the oven does not light within 20 seconds turn off the control knob and wait for 30 seconds before trying again.
- (ii) Once the oven is lit it will be necessary to keep the control knob depressed for 5 to 10 seconds to ensure the flame failure device is heated up enough to operate.

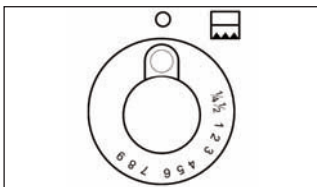

Oven control knob

Refrigerator Operation

CAUTION

When the motorhome is on the road the refrigerator should only be operated from the vehicle battery and not by means of the bottled gas.

The refrigerator can be run on 230V or LP gas whilst stationary. Changing between these modes of operation is carried out by means of the controls shown on the relevant control panel on the refrigerator.

CAUTION

Only use one source of energy at a time.

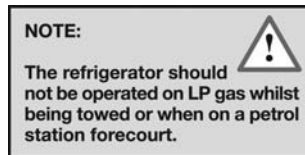

Autoquest Fridge.

Gas operation

Turn the fridge energy source control knob, on the left hand side of the fridge, onto gas as shown by the flame symbol. Turn the gas control knob, on the right hand side of the fridge, to maximum i.e. all the way clockwise. Now depress and hold the gas control knob and depress the piezo ignition button several times at intervals 1 - 2 seconds.

When the gas ignites the needle in the viewing window next to the piezo ignition button will go into the green of the viewing window. If the fridge fails to ignite after 5 attempts release the gas control knob and wait for 30 seconds before trying again.



Energy selector switch

Thermostat Knob



Fridge.

Please Note: If the refrigerator is being used for the 1st time in a while then it may take a couple of attempts to purge the gas pipes of air before the refrigerator lights on gas.

230V Operation All Fridges

- (i) Ensure that the motorhome is connected to a mains hook up and that the mains control panel is switch on.
- (ii) Turn the refrigerator control knob, located on the left of the refrigerator, to the mains position as indicated by the plug symbol. The refrigerator should start to operate on mains.

12V Operation All Fridges

Turn the refrigerator control knob to the 12V position as indicated by the battery symbol. Please note that this function is only available when the motorhome is connected via the 12n and 12s plugs to a driving vehicle.

Water Heater Operation

Gas operation

- (i) Ensure that the water heater has been filled with water and that the outside flue cover has been removed.
- (ii) Using the Ultrastore control knob, turn the dial to the desired temperature setting then turn the outer ring to the flame position.
- (iii) Once the Ultrastore is switched on a green light is visible within the switch and the unit will now try and ignite.
- (iv) If within approximately 10 seconds, the Ultrastore fails to ignite then a red failure light will also appear. If this happens wait 30 seconds before trying again.

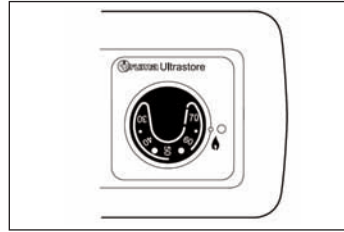

230V Operation

Simply depress the Electrical switch fitted next to the gas control to the 230V position. This will turn on the water heaters electrical element. It is imperative that there is water in the heater whenever the Gas or Electric is switched on.

Space Heater Operation

Gas Operation

- (i) Turn the gas control on top of the heater to the desired setting and depress the knob.
- (ii) Keeping the control knob depressed look into the viewing window and see if the gas ignites. If you have an automatic ignitor then you should hear it ticking and eventually see the pilot light. If however you have Piezo ignition then you will have to manually depress the ignitor repeatedly until you see the pilot light.
- (iii) Once the pilot light is lit keep the control knob depressed for a further 20 seconds to allow the thermocouple to operate.
- (iv) If the heater fails to ignite please wait 20 seconds for trying again.

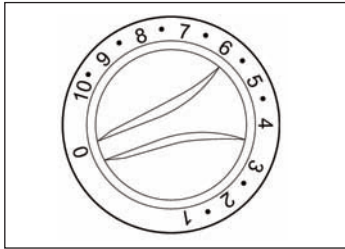

Gas Control

Electric Operation

- (i) Simply depress the main switch on the Ultraheat control panel to the 230V position.
- (ii) Then set the power rating you require on the panel at either 500w 1000w or 2000w.

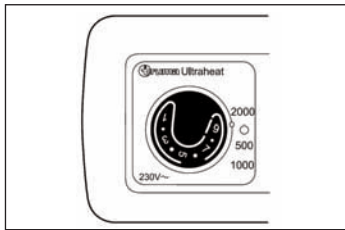

Electric control

Fan Operation (Option on Autoquest)

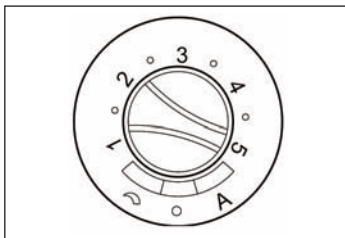

Fan Control

The blown air function of the space heater is controlled by the three-position switch on top of the heater.

- (i) Position 0 is off.
- (ii) Position A operates the fan in automatic mode. In this position the fan will only run when there is sufficient heat to require the air to be circulated.
- (iii) The third Position will operate the fan at all times.
- (iv) The speed of the fan is controlled by the number position set with 5 being the fastest speed and 1 being the lowest.

Battery Charger

The battery charger for the motorhome battery will automatically switch on when the motorhome is connected to a mains supply. The battery charger will also provide a 12V supply to the motorhome when a battery is not connected. Please note that the battery charger fitted is designed to keep your battery charged and is not designed for charging up a flat battery.

Smoke Detector

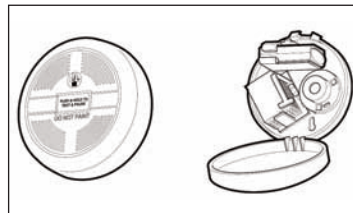

The motorhome smoke detector will become active once the 9V battery that should be supplied with the smoke detector is connected. The smoke detector fitted to your motorhome has an alarm pause mode that will reduce the sensitivity of the alarm for a short period to allow for cooking within the motorhome. The alarm pause mode is activated by pressing the button



marked HUSH on the smoke detector. While the detector is in the pause mode the detector will beep once per minute to alert that the alarm pause mode is activated.

Rooflights

Your motorhome is fitted with at least one type of the following roof lights.

The Heki 2

To Open To The Tilted Position:

- (i) Press the knob in the toggle catches on either side of the rooflight and turn through approx. 90°.
- (ii) Grasp the metal bar in the middle, snap it out of its holder, swivel down and press the rooflight upwards. (The rooflight is held by the two gas springs after approx. 150mm).
- (iii) Swivel the metal bar towards the rooflight and snap into its holder.
- (iv) To close the rooflight, proceed with steps (i to iii) in reverse order.

To Open In The Intermediate Position:

- (i) Open the toggle catches on either side of the rooflight.
- (ii) Grasp the metal bar in the middle; snap it out of its holder, swivel down and press the rooflight outwards. (Rooflight is opened automatically after approx. 150mm by the two gas springs.)
- (iii) Open both fasteners and swivel the metal strap toward the intermediate position and pull the rooflight down until the metal strap is stopped by the fasteners.
- (iv) To close, proceed with steps (i to iii) in reverse order.

To Open In The Ventilation Position:

- (i) Open the toggle catches on either side of the rooflight.
- (ii) Using both hands on the two toggle catches, press the rooflight up about 2cm and fasten the toggle catches in the corresponding setting.
- (iii) To close, proceed with steps (i -ii) in reverse order.

Closing The Blinds:

- (i) Take hold of the end rod (without rocker) in the recessed grip and engage in the opposite end rod (with rocker).
- (ii) Select the required position (blackout/ flyscreen) by moving both joined end rods together.

CAUTION

In extremely bright sunshine, the blackout blind must only be closed two-thirds, and the rooflight must be set in the continuous airing position.

Opening The Blinds:

- (i) Move blind (end rod with rocker) right to the outside.
- (ii) Hold the recessed grip with one hand; with the other hand, press the rocker and move the blind back (do not let it recoil).

CAUTION

- Do not stand on the acrylic rooflight.
- Close HEKI 2 completely before moving off.
- Do not leave your Motorhome when HEKI 2 is open.
- Please consult your supplying dealer if you have any problems or defects.
- Remove any snow/ice or dirt before opening the roof.
- Do not open when it rains or when there is a strong wind.

Standard MPK Rooflight

The MPK 400 x 400 rooflight is generally fitted in washroom areas.

- (i) Lowering the flyscreen then pressing the black control rod in towards the centre of the rooflight.
- (ii) Then while the rods are depressed, push upwards to open the rooflight.

Door Flyscreen

The exterior door flyscreen can be opened or closed from both inside and outside of the Motorhome and does not restrict door openings. When opening or closing the door flyscreen use the finger grip provided.

Windows

Your new Autoquest or Avantgarde Motorhome will be fitted with Polyplastic opening windows.

Polyplastic Window Opening

- (i) In order to open the Polyplastic window it is only necessary to move the catch upwards and release the catch from the backing plate.
- (ii) The Polyplastic window should remain in the open position once opened, however if it does not then tighten the friction control on the window stays to increase the holding force.
- (iii) The Polyplastic window is also fitted with a night ventilation position where the catch is set to the centre position on the backing plate; in this position it may be possible for rain to enter the motorhome in adverse conditions.

Taps

Kitchen Taps

Your new motorhome will be fitted with a Whale mixer tap.

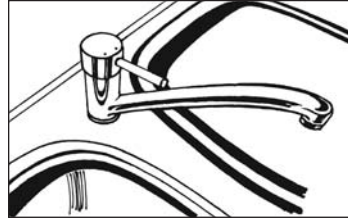

Operation

For correct operation of the tap swivel the spout to the desired position over the sink. Lift the control lever to activate the pump and allow water to flow simultaneously. To adjust the temperature, swivel the lever to the left to increase the temperature and to the right to reduce the temperature.

CAUTION

The water temperature could be very high so do not lift the lever with the tap turned to the full left position. For winter storage and to prevent frost damage the tap swivel must be left in the centre up position.

Washroom Taps and Showers

Your motorhome will be supplied with either a vanity mixer tap or separate shower mixer, or with a combined mixer tap with retractable shower head.

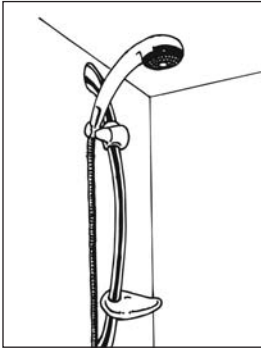

Operation

The mixer tap and shower mixer are operated in the same manner as the kitchen tap by lifting the control lever to activate the pump and swiveling the lever left or right to determine the temperature.surface.

PLEASE NOTE

- A. The water temperature could be very high so do not lift the lever with the tap turned to the full left position.
- B. For winter storage and to prevent frost damage the tap swivel must be left in the centre up position.

Exterior Doors Retainers

The exterior door can be secured to the side of the motorhome by pushing the door retainer into the spring clip.

To comply with European Standards, the exterior door lock must not be replaced with a double dead lock.

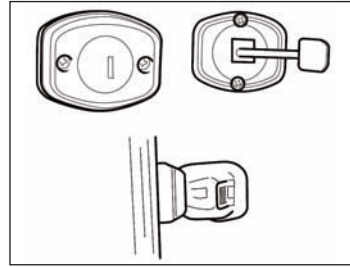

Internal Doors

Toilet / Washroom Doors

Toilet / washroom doors are fitted with a level lock, which is operated by pushing the lever down. The level is spring-loaded and will return to the closed position upon release. It is recommend that the lever is always used when the closing the door.

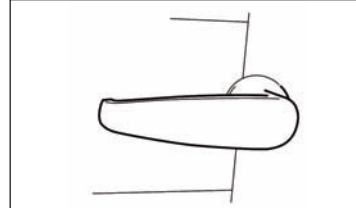

Toilet / Washroom Doors.

Other Internal Doors

Other internal doors such as the wardrobe and table storage locker are fitted with a 2-position button lock. Push the button to lock the door and the button should remain flush with the door. Push the button again to release and the button should then protrude from the door surface.

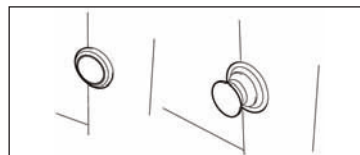

Other Internal Doors

Magnetic Catches

Magnetic catches work on contact with the metal plate on the rear of the door. Simply close the door until the magnet engages and holds the metal plate. Pulling the door towards you with a moderate force will be sufficient to disengage the magnetic catch and open the door.

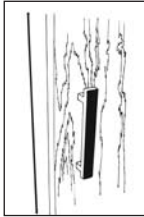

Sprung Hinges

Overhead lockers will use sprung hinges. These are suitably strong enough when closed to securely retain the door and prevent it from opening in transit. Pulling the handle towards you with moderate force is sufficient to open the locker door and hold it in the open position.

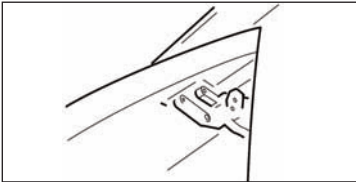

TV Aerial - (Option)

Your new motorhome may be fitted with a 315 Status TV aerial

Status 315 Omni Directional Aerial (Where Fitted)

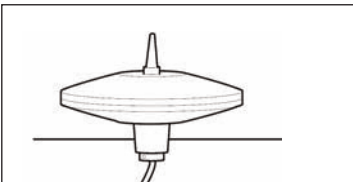

To operate your 315 omni directional TV aerial follow the procedure outlined below

- (i) Switch ON the power pack and the red LED will illuminate
- (ii) Check the gain control switch is set to the normal "NML" position (Switch up).
- (iii) Turn on your television set and tune in. This may be necessary at all new locations.

FM Radio Connections

The Status aerial is designed to receive FM radio when connected to a car-style radio.

- (i) This will require a coaxial car radio plug, a coaxial plug and a length of coaxial cable, which are available from your local motorhome retailer.
- (ii) Assemble the cable and plugs and route the cable from the power pack to the radio.
- (iii) Insert the plug into the back of the radio and into the TV-FM socket of the power pack.

Please Note: For information on the Entertainment equipment provided in your motorhome please refer to the instruction manuals provided in your Owners information pack.

Thetford cassette toilet

Your motorhome is fitted with a bench or rotatable cassette toilet.

Rotatable toilet

Preparing the Toilet for Use

Open the access door on the outside of your motorhome.

Rotate the waste tank emptying spout 90 degrees and remove the water filling extension (you will find it positioned beneath the handle closest to the emptying spout).

Rotate the water fill funnel outwards, remove the cap and place the extension on the water fill



funnel. Add the stated amount of Thetford fresh water additive to the water tank. This ensures a better and cleaner flush and keeps the water in the flush tank fresh.

Fill the water tank with clean water. Warning: keep water level below the top of the water filling funnel.

Remove the extension and return to its original position on the waste tank.

Please Note: Depending on the space between the door and waste tank, this extension part may also be fixed on the door with a hook.

(vi) Screw the cap back onto the water filling funnel and push back inwards towards the side of the flush water tank.

Please Note: 150 ml of water will remain in the water fill funnel when the water tank is empty.

Emptying the Toilet

Open outer locker door and release bottom or base catch securing cassette.

Remove cassette, ensuring the flap is in the closed position (it is useful to use a trolley for taking waste tanks to the disposal point).

Take the cassette to a chemical toilet waste disposal point, remove cap and place safely away from emptying point. Press air release button near handle before you tilt the tank to empty contents.

Rinse well and then leave some water in and replace cap.

When you get back to your motorhome, add chemical solution as instructed.

Replace cap and fold arm away.

Slide back into locker until catch locks.

Close and lock door.

For further information please refer to the appliance instructions supplied in your owners information pack.

BENCH TOILET

Preparing the toilet for use

1. Open the access door on the outside of your motorhome.
2. Rotate the waste tank emptying spout 90 degrees and remove the water filling extension (you will find it positioned beneath the handle closest to the emptying spout).
3. Rotate the water fill funnel outwards, remove the cap and place the extension on the water fill funnel. Add the stated amount of Thetford fresh water additive to the water tank. This ensures a better and cleaner flush and keeps the water in the flush tank fresh.
4. Fill the water tank with clean water. Warning: keep water level below the top of the water filling funnel. Its original position on the waste tank.

Note: depending on the space between the door and waste tank, this extension part may also be fixed on the door with a hook.

Screw the cap back onto the water filling funnel and push back inwards towards the side of the flush water tank.

Note: 150 ml of water will remain in the water fill funnel when the water tank is empty.

6. Remove the waste tank by pulling the safety catch upwards.
7. Pull the waste tank outward to the stop. Tip it slightly and take the tank fully out.
8. Place the tank upright and turn the emptying spout upwards.
9. Remove the cap, with the measuring cup inside, from the emptying spout and pour the stated quantity of toilet fluid into the waste tank. This avoids unpleasant smells in the waste tank and keeps the inside of the



waste tank clean. Next add approximately 2 litres of water - enough to ensure that the bottom of the waste tank is covered. Screw the cap back onto the emptying spout. Turn the emptying spout back to its original position.

N.B: The emptying spout measuring cap is supplied in the same packaging as this manual.

Warning! Never add toilet fluid via the valve blade or via the toilet bowl.

10. Slide the waste tank back into its original position via the access door.

Note! Never use force if you cannot get the tank back into place easily. This may cause serious damage.

11. Make sure that the waste tank is secured with the safety catch. Shut the access door and lock it.

USE

12. Run water into the bowl by pressing the flush knob briefly or open the valve blade by turning the handle anti-clockwise. Your Thetford toilet is now ready for use.

13. After use, open the valve blade (if still closed) by turning the handle anti-clockwise. Flush the toilet by pressing the flush knob for several seconds. Close the valve blade after use.

Note! Do not leave water in the bowl if the toilet is not being used. This does not help to reduce unpleasant smells and only leads to flooding.

Important Warning Notice! Please do not travel with water in the flush tank of your toilet. Failure to adhere to this notice may result in water damage to your motorhome.

EMPTYING

The waste tank has a capacity of 19 litres and must be emptied at the latest when the red light in the level display lights up. The indicator lamp will light up when the waste tank can

still take about 2 litres, which is about 3 uses. It is advisable to empty the waste tank earlier.

Note! Do not allow the waste tank to become too full.

14. Make sure that the valve blade is closed. Open the access door located outside the vehicle. Pull the safety catch upwards and remove the waste tank.

15. Remove the water filling extension first to avoid it getting lost during emptying of the waste tank.

16. Stand the waste tank upright (Pull-out handle at the top, wheels at the bottom). Press the handle down and move it away from the waste tank until it snaps out of its locked position.

17. Pull the handle up and wheel the waste tank to an authorised waste dump.

18. Push the handle back. Turn the emptying spout upwards and remove the cap from the spout. Hold the waste tank by the upper handle with one hand, while placing your other hand by the rear handle so that during emptying you can operate the vent plunger with your thumb. To empty the tank without splashing, depress the vent plunger while emptying the tank.

After emptying, flush the tank thoroughly with water. Also clean the valve blade with water.

Note! The vent plunger should only be pressed once the emptying spout is pointing downwards!

19. If required make the toilet ready for use once again. Return the water filling extension to its original position on the waste tank.

Slide the waste tank into the toilet and close the access door.



Please note that Thetford recommend not to travel with water in the flush tank of the C400 bench cassette toilet.

When entirely necessary, up to 2 litres can be added to the flush tank giving you enough water for 2 flushes. Having less than 2 litres of water in the flush tank will not cause any damage to the toilet or the Motorhome.

Please be aware that travelling with more than 2 litres of water in the flush tank can cause water damage to both the toilets compartment and to the Motorhome itself as water can escape from around the flushing mechanism. This is due to the fact that the flushing mechanism is used as the entry point for anyone needing to carry out maintenance procedures and is therefore not water tight.



How To Make Up Your Beds

100 – 130

Step 1 Remove all cushions from the front and rear facing seats.

Step 2 Pull out the bed slats located between 1 and 2 and fully extend as shown.

Step 3 Place cushions as shown in the diagram.

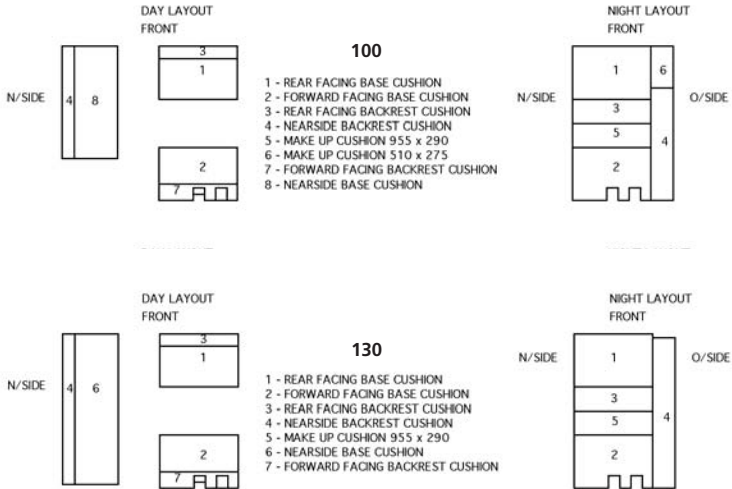



How To Make Up Your Beds

120 – 115 -140

Step 1 Remove the centre cushion (5).

Step 2 Slide out the bed slats from under the centre seat.

Step 3 Place cushions on beds as shown.

DAY LAYOUT

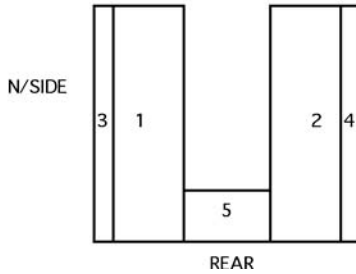

120 - 115 - 140

- 1 - NEARSIDE BASE CUSHION
- 2 - OFFSIDE BASE CUSHION
- 3 - NEARSIDE BACKREST CUSHION
- 4 - OFFSIDE BACKREST CUSHION
- 5 - REAR BASE CUSHION

NIGHT LAYOUT

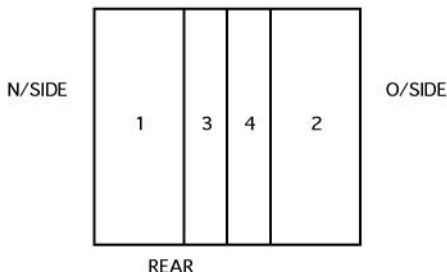



How To Make Up Your Beds

145

Step 1 Remove and store cushion 3.

Step 2 Pull out the sliding bed slats into the centre of the bed.

Step 3 Place the cushions on the bed as shown below.

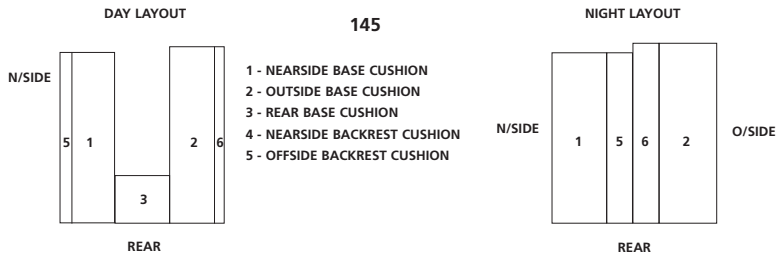



How To Make Up Your Beds

180

FRONT DINETTE

Step 1- Remove all cushions from the front and rear facing seats.

Step 2- Pull out the bed slats located between 1 and 2 and fully extend as shown.

Step 3- Place cushions as shown in the diagram.

REAR BED

Step 1- Remove the centre cushion (7).

Step 2- Slide out the bed slats from under the centre seat.

Step 3- Place cushions on beds as shown.

FRONT DINETTE

DAY LAYOUT



N/SIDE

O/SIDE

NIGHT LAYOUT

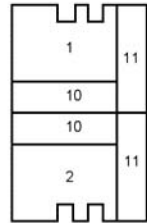

N/SIDE

O/SIDE

180

- 1 - REAR FACING BASE CUSHION
- 2 - FORWARD FACING BASE CUSHION
- 3 - REAR FACING BACKREST CUSHION
- 4 - FORWARD FACING BACKREST CUSHION
- 10 - MAKE UP CUSHIONS 2 @ 955 x 286
- 11 - MAKE UP CUSHIONS 2 @ 986 x 275

REAR BED

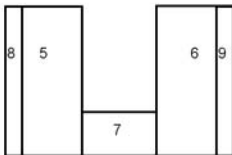

REAR

- 5 - NEARSIDE REAR BASE CUSHION
- 6 - OFFSIDE REAR BASE CUSHION
- 7 - REAR BASE CUSHION
- 8 - NEARSIDE BACKREST CUSHION
- 9 - OFFSIDE BACKREST CUSHION

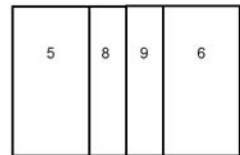

Over Cab Double Bed

If your new motorhome has an over cab bed fitted then in order to put the bed into the sleeping position simply pull down on the ladder fixing the bed will come down to a horizontal position and the gas struts will lock in place.

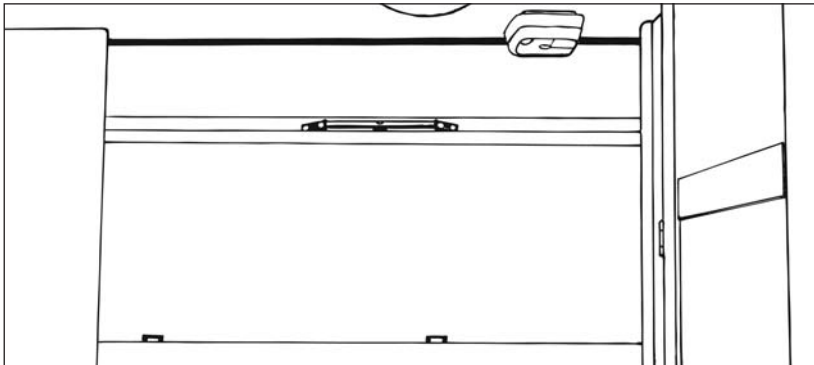

Over cab bed in the up position

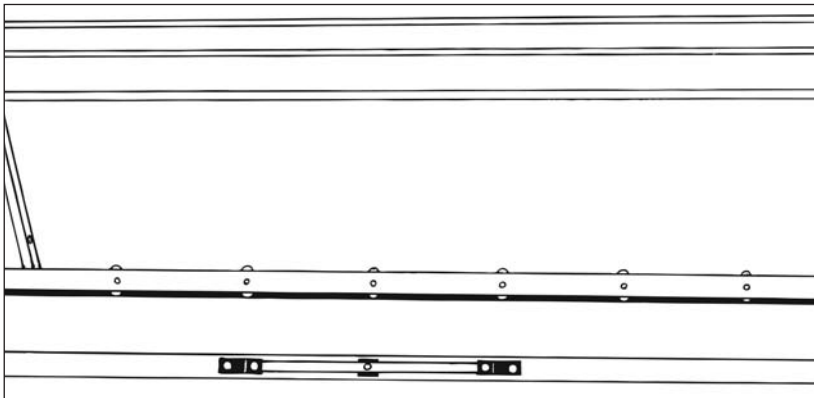

Over cab bed in the down position



10-1 SECURITY

Theft deterrent, prevention and security of your motorhome is taken very seriously at The Explorer Group. That is why we have provided a combination of standard features and optional extras designed to deter and prevent thieves from stealing your property. And in the unlikely event that they should succeed, aid the identification and speedy recovery of your property to assist in the prosecution of the thief.

Motorhome Theft

The theft of a motorhome can occur in the most unlikely circumstances; from a motorway service area, even from an owner's driveway. Secure all windows and doors when your motorhome is unoccupied, even if only for a short length of time.

Explorer Protect - Autowatch Alarm System (Option)

Manufactured by Autowatch, The Explorer Protect system is designed to give years of trouble free operation. Made with only the highest quality components and using state of the art technology you can be assured that your motorhome has the best electronic protection available. Each motorhome alarm is installed with a Passive Infrared Detector (PIR), a wireless sensor that detects movement in the motorhome and transmits a radio signal to the alarm module. If the alarm is on the siren will sound, and a door contact sensor, fitted to the main exterior habitation door.

Additional sensors can be purchased from your retailer to enhance security.

See section below for operation or consult the manufacturers instructions provided in the Owners Information Pack.

Additional Security

Consider fitting any device which might deter or prevent intrusion by thieves. For example: A wheel lock will prevent driving of the motorhome and removal of the wheel.

Free Crime Prevention

Advice about securing your motorhome, protecting your valuables, property marking, either at home or whilst on site, can be obtained from the Crime Prevention Officer through your local Police Station.

Explorer Protect Autowatch 650 Motorhome Alarm (Option)

Basic Operation Arming the System

- (i) Briefly press (large) arm/disarm button.
- (ii) Single chirp.
- (iii) Awning light illuminates for 30 seconds.
- (iv) Settling time of 15 seconds before responding to triggers.
- (v) Single intermittent flash of status LED (every 2 seconds).
- (vi) All sensors triggered will result in siren sounding for 30 seconds, or until reset by pressing the arm/disarm button.

Disarming the System

- (i) Briefly press the (large) arm/disarm button.
- (ii) Double chirp.
- (iii) Awning light illuminates briefly on and off and then on again for 30 seconds.
- (iv) LED off.



Panic Alarm

- (i) Press and hold the small panic button on the transmitter for two seconds.
- (ii) The siren will sound for thirty seconds, unless reset by pressing any of the transmitter buttons.

Emergency Disarm.

Insert the touch-key briefly into the socket. The alarm will turn off.

Silent Arm and Disarm.

- (i) Press the small button briefly followed by a press on the arm/disarm button.
- (ii) The alarm will arm/disarm without chirps.

Sensors

Each motorhome alarm is installed with a Passive Infrared Detector (PIR) and a door contact sensor, fitted to the main exterior habitation door.

Passive Infra Red Sensor

The wireless PIR sensor will detect movement in the motorhome and transmit a radio signal to the alarm module, if the alarm is on the siren will sound.

Door Sensor

The door sensor will activate when the exterior habitation door is opened.

Enhanced Features Arming The System In "At Home" Mode.

In the 'at home' mode, any sensor that is programmed to be isolated, such as the PIR sensor will not trigger the alarm. Other sensors, such as the door contact sensor, will trigger the siren. Arm as normal followed by a second press on the arm/disarm button within 2 seconds. Normal "on" tone followed by "at home" tone indicating isolation is active. Settling time of 15 seconds before

responding to triggers. Armed in the isolation mode will be indicated by a double flash intermittently of the LED. The "at home" sensors will be isolated; other sensors will trigger the siren for 30 seconds.

Arming the System in Test Or Buzz Mode

In the buzz mode the siren will sound a short tone when a sensor is triggered instead of sounding for 30 seconds. It is advisable to test all the sensors.



11-1 CARE OF YOUR MOTORHOME

This section of the guide is devoted to the care, cleaning and general preservation of your motorhome in order to retain its showroom condition.

Exterior Body Shell

The exterior painted body shell of your motorhome, usually the side walls, is acrylic finished aluminium, which is extremely durable and easy to clean. It is recommended you first wash off any caked dirt and mud with cold water then use a proprietary brand wash and wax shampoo and rinse with plenty of cold water.

CAUTION

Under no circumstances should an abrasive or harsh cleaner be used. Do not use a pressure washer as this can disturb mastic seals.

Glass Fibre Reinforced Plastic (GRP)

GRP components need to be washed, waxed and taken care of like a car. Chemicals and dirt can collect during storage, and the gel coat can be stained or marked when chemicals combine with rain or dew. Most stains or marks can be removed with mild dishwashing detergent, but more stubborn marks may require a (fine grit) rubbing compound such as T-cut. To help keep your GRP components looking almost like new, it is wise to wash the parts monthly (or more frequently) using mild dishwashing detergent, but avoid using strong alkaline (e.g. trisodium phosphate) or acidic cleaners or abrasives. Waxing the components once or twice a year with a good grade paste wax will help to maintain the colour and finish.

Acrylic Windows

Your motorhome is fitted with shatter resistant acrylic windows. To preserve their clarity and unblemished transparency it is essential that the following cleaning instructions are strictly adhered to: Road grit, dust, sand, flies, lime tree secretions, bird droppings etc., should be washed off using plenty of cold water do not use a sponge to clean off heavy dirt deposits. Any remaining dirt should be washed off using a soft cloth and warm water. Under NO circumstances should any abrasive cleaning agents, household detergents or proprietary cleaning fluids be used. Wash the window again using only cold water and dry off with chamois leather.

Please Note: Should scratches appear on the acrylic windows these can often be removed with an acrylic polish. E.g. ICI Perspex polish. Gentle polishing with a liquid metal polish, i.e. Brasso may also have the desired effect – consult your retailer BEFORE attempting to remove any but the slightest scratch.

Window Blinds & Flyscreens

To clean the blinds and flyscreens, moisten a soft cloth or sponge with a small amount of water and mild soap suds and gently wipe dirt off. Allow to dry before retracting, failure to do this could result in mildew forming.

ABS - Wheel Spats & Panels

To preserve the appearance of all ABS panels and fittings road grit, dust, sand, flies, lime tree secretions, bird droppings etc., should be washed off using plenty of cold water. Any remaining dirt should be washed off using a soft cloth and warm water. Under NO circumstances should any



abrasive cleaning agents, household detergents or proprietary cleaning fluids be used. Wash the ABS material again using only cold water and dry off

Interior Walls

Your motorhome interior walls will only require a wipe over with a damp cloth, using a mild detergent, to keep them in a 'showroom' condition.

Furniture

Treat your motorhome furniture as you would the furniture in your home. Polish wood surfaces sparingly with a good quality wax or spray polish. Use a damp cloth to clean Melanate laminated surfaces.

Carpets, Upholstery and Curtains

Vacuum clean carpets and upholstery to ensure a long life, marks on cushions can be removed using a mild upholstery shampoo with the minimum of water. Curtains should be dry cleaned only.

Washroom and Handbasin Fittings

These should be cleaned using a non abrasive household cleaner. Always put the cold water into the hand basin before adding the hot in order to preserve the finish of the thermoplastic formed basin.

Please Note: Under no circumstances should alcohol, spirit or solvent-based liquids be used on GRP or ABS plastic panels as these substances may react with the material and cause visible damage.

Shower Trays

Only clean your shower tray using soap and water. Do not use chemical based cleaning agents as this may attack the material of the tray.

Water Systems

The water systems, and in particular storage tanks, in motorhomes are susceptible to contamination by bacteria if care is not taken with their use and cleaning. The symptoms caused by bacterial contamination are not purely limited to gastrointestinal diseases, but may also manifest themselves as ear, nose, throat, and eye or skin infections. It is therefore important that you carry out the following procedure prior to using the motorhome each time, even if you boil or filter all water you use for drinking.

Please Note: If your motorhome is not going to be used for an extended period of time it is recommend that you disconnect the vehicle battery to prevent the battery from discharging.

Water Containers

- (i) All water remaining in any water container should be disposed of so that the container is empty.
- (ii) The outside of external water contains should be thoroughly cleansed and washed down to remove any dirt, dust or other contaminant. Water at a suitably hot temperature containing an appropriate detergent is recommended for this purpose. Water should then be put into the container, swirled round, and then emptied out.
- (iii) All containers should then be totally filled with water containing an appropriate disinfectant / sterilising solution and allowed to stand for the recommended contact time (e.g. Milton for 15 minutes).
- (iv) The solution should be emptied from the container.



- (v) The opening of the any container should be cleaned thoroughly with an appropriate pre-prepared wipe impregnated with a disinfectant / sterilising solution.
- (vi) External containers should be inverted whilst stored overnight (if possible).
- (vii) Containers must be filled with mains water only and mains water only should be used for the above cleaning procedure.
- (viii) On no account should garden hoses be used to fill water tanks.

Internal Water Systems

- (i) Drain down the system. (Open all taps to allow air in, enabling the system to drain quickly.) See Index – Draining Down The Water System.
- (ii) Remove any water filters fitted, and replace with a short length of hose or empty filter cartridge (this will ensure the filter is not affected by the disinfectant / sterilising solution).
- (iii) Fill the system by using the pump with a disinfectant / sterilising solution. (Check that the solution at full strength appears at all taps/showers). Allow to stand for the recommended period of time.
- (iv) Drain the system down completely.
- (v) Thoroughly clean the outside of all taps/connectors with a cloth soaked in the disinfectant / sterilising solution.
- (vi) Flush the system through with clean drinking water until no traces of disinfectant / sterilising solution can be detected at any tap.

- (vii) Replace the filter. Suitable sterilising chemicals are available from your Explorer Group Retailer, accessory shop, chemists, or home-brew shops. It is not, however, recommended to use bleach or sodium metabisulphide.

Truma Space Heater

Please Note: Your Truma Space Heater front is now attached using 2 screws. These screws must be removed prior to removal of the Space Heater front. These screws can be seen when looking into the fire through the air vents.

Thetford Toilet

WARNING

Cold Weather Use – To prevent freezing during cold weather use, add antifreeze to the toilet system fresh water tank. Use a non-toxic (propylene glycol) type of antifreeze. Refer to chart on container to obtain level of protection.

Warmer Weather Use – In warmer weather or longer intervals between emptying the waste tank you may require additional toilet fluid. Use only Thetford toilet fluid to achieve the best results.

CAUTION

- Never add toilet fluid directly into toilet bowl.
- Do not use strong household detergents or cleaners that contain chlorine, solvents or acid contents.
- High Altitude and Hot Weather Use – with large temperature differences and changing heights during driving, pressure can start to build up in the waste holding tank, causing contents to splash upward upon opening the valve blade if opened too fast.



Changing A Wheel

- (i) Ensure handbrake is applied and chock the wheel diagonally opposite the wheel to be removed.
- (ii) Remove the hub cap. (If applicable)
- (iii) Use wheel brace to slacken off wheel nuts on the wheel to be changed.
- (iv) Position jack at the appropriate jacking point (see Peugeot vehicle handbook).
- (v) Jack up the motorhome until the wheel for removal is just off the ground.
- (vi) Remove the wheel nuts and remove the wheel.
- (vii) Fit spare wheel and reverse the above procedure.
- (viii) Tighten wheel nuts in accordance with the Peugeot handbook instructions.

WARNING:

Ensure the wheel is of the same construction and size as the one that has been removed.





12-1 STORAGE FOR LONG PERIODS

If your motorhome is to be stored for any length of time, especially over the winter period, the following operations are recommended:

- (i) Remove all linens, blankets, cushions, clothes, mattresses, etc. that could be affected by damp conditions
- (ii) Clean the motorhome inside and out as detailed in the previous section
- (iii) Drain the water system (see index).
- (iv) Ensure all windows, roof lights and doors are correctly fastened. Check fixed ventilation apertures are not obstructed
- (v) Check that the site you have chosen to store the motorhome is open, fairly high and dry and if possible not exposed to gales etc. If this proves impossible it is recommended that the motorhome chassis is anchored to the ground.
- (vi) Jack up the motorhome (use bottle or screw jack), so that the wheels are clear of the ground. Support the motorhome axle with wooden blocks, axle stands or similar so that when the jacks are removed the wheels remain clear of the ground. Cover the tyres to prevent deterioration.
- (vii) Release the handbrake.
- (viii) Removing the wheels reduces the risk of motorhome theft.

Motorhome Covers

Covers may be used to protect your new Explorer Group motorhome provided that the cover used is of a breathable type. Ensure that any sharp objects are removed e.g. the point of a status omni-directional aerial, and that the cover is well tied down. Your motorhome must be ventilated every 4 to 6 weeks if it is to be stored with a cover in place.

Power Drain

In order to reduce any drain on your Leisure Battery while your motorhome is being stored you should ensure that the main control switch on the refrigerator is set to the 0 position

Please Note: If you have the Explorer Protect alarm fitted and you disconnect the leisure battery the alarm will run off the back-up battery for approximately 2 weeks.

Should the motorhome be stored for a prolonged period of time it is strongly recommended that the motorhome is fully serviced before the commencement of use. Your retailer will ensure that your motorhome is safe, secure and ready for your enjoyment.



13-1 WARRANTY

3-Year Manufacturer's Warranty

Subject to the following conditions, your motorhome is supplied with a manufacturer's warranty for 3 years from the original date of purchase, at no additional cost to you the customer. We sincerely hope you will never have cause to complain about your motorhome. However, if you do have a problem then please contact your Retailer so they can report this through our warranty system. We are confident they will do their utmost to resolve any problems to your complete satisfaction. The Retailer from whom the motorhome is purchased is liable for warranty repairs. Any other approved Retailer or Service Centre may carry out work at his own convenience and/or discretion, but is not obliged to do so.

Parts Covered By This Warranty for Years 1 -

Subject to the specific exclusions in years 2 and 3 set out below all original components of the motorhome, including permanently fitted equipment, forming part of the manufacturer's original specification.

Specific Exclusions for Years 2 & 3

Tyres, batteries, plastic windows, glass, exterior paint work, bright work and all similar trim and finish, soft furnishings, carpets and floor coverings.

Entertainment/communication systems and connected equipment. Adjustment of blinds, hinges, catches, stays and doors.

Replacement of bulbs, fluorescent tubes, fuses and electrical connections; GRP, ABS and PVC products, wheel spats and shower trays. Natural movement of internal

doors and furniture. Normal wear and tear/servicing items and other components subject to routine maintenance.

Conditions Attached To The Warranty:

- (i) The duration of the warranty is 36 months from the original date of purchase.
- (ii) That the original construction of the motorhome has not been tampered with or repaired other than by Explorer Group or an approved Retailer or Service Centre.
- (iii) That an "annual" habitation service, damp and safety check has been carried out by an approved Retailer or Service Centre. The first and second services are due 60 days either side of the anniversary of the original date of purchase. The interval between services must not exceed 14 months. The third service must be on or before the anniversary date of the original purchase.
- (iv) That original VAT service invoices are retained as proof that annual service and inspections have been carried out.
- (v) No work should be commenced under the terms of the warranty unless prior authorisation is obtained from Explorer Group.
- (vi) Explorer Group reserves the right to inspect the motorhome before any work commences.



WARRANTY

- (xii) No liability will be accepted for damage caused by fair wear and tear, wilful damage, negligence, abnormal working conditions, intrusion of foreign or harmful matter, overheating, freezing, failure to follow Explorer Group instructions, misuse or alteration or repair of the motorhome without The Explorer Group prior approval.
- (xiii) Motorhomes covered by this warranty shall not be put out to hire, reward, or any other commercial use or used in any timed race.
- (xiv) That the motorhome shall be used only for its ordinary and intended purpose and shall not be subjected to any condition which could reasonably be foreseen to cause or result in damage or excessive wear and tear.
- (xv) That no liability arises from this warranty for transport costs to and from the place of remedial work or consequential cost relating to transportation. No liability arises out of this warranty for any indirect, special or consequential loss or damage (whether for loss of profit, use, contract, goodwill, or otherwise), costs, expenses or other claims for compensation howsoever arising.
- (xvi) No liability will be accepted for any accidental or fire damage or any loss incurred by accident or fire.
- (xvii) The unexpired period of the 3-year warranty is transferable to second and subsequent owners during the 3-year period. The new owner should contact Explorer Group within 3 months of their purchase, with proof of ownership, service history and their payment of £30 to have their details recorded in our database.

Please Note: This warranty does not affect the purchaser's statutory rights.

This warranty shall be governed and construed in accordance with the laws of England and the parties irrevocably submit to the exclusive jurisdiction of the courts of England.

Please Note: In order to maintain your Peugeot warranty you will be required to fulfil their warranty requirements, as detailed in your Peugeot handbook



14-1 CODE OF PRACTICE - WATER INGRESS

At Explorer we want our customers to be sure that, in buying one of our motorhomes, you are buying the very best. We would like you to continue to believe this for a long time after you have made your purchase.

We are confident that our new motorhomes, built with innovative manufacturing techniques and tested materials, make water ingress concerns unnecessary.

We are so confident of our new motorhomes that we follow a 'Code of Practice' which gives certain guarantees to our customers, both consumers and Retailers, of financial reimbursement for remedial work costs should problems occur.

The Code

The code applies to all new Explorer Group products manufactured after 1st September 1998.

All owners with documentary proof of annual services by an approved Explorer Group Retailer or Service Centre will be paid in full for the costs of remedial work due to water ingress. This is valid for up to 5 years from the original date of purchase of a new product.

Unless the motorhome has a full service history, the owner will be required to contribute to the costs of remedial work for water ingress damage depending upon the age of the motorhome and work required. Each case will be examined on its own merit. Explorer will decide the amount of contribution towards the remedial work costs.

Owners exchanging their current Explorer Group model for a new

Explorer Group model will not have the value of their part exchange reduced due to potential water ingress issues, providing that there is documentary evidence that the motorhome has been annually serviced and that it is less than 5 years old.

Conditions Attached To the Code

- (i) Work may only be undertaken after approval by Explorer (depending upon individual circumstances).
- (ii) Explorer will pay the costs of remedial work, only after approved work has been carried out.
- (iii) The Code is not retrospective.

Customer Obligation - Servicing

It is a condition of your warranty that your motorhome must have an "annual" habitation service, damp and safety check and this should be carried out by an Explorer Group approved Retailer or Service Centre, in accordance with NCC guidelines. Proof of this will be required in the event of a warranty claim.

Please Note: Failure to do so will invalidate your warranty.

The first service is due 60 days either side of the anniversary of the original date of purchase. The interval from purchase date to the first service and the intervals between services must not exceed 14 months. Years 3 and 5 must be on or before the anniversary date of the original purchase.

Your motorhome requires servicing for safety, efficiency and to protect the investment you have made. Whether the motorhome is used for short trips or continental long range touring, regular servicing is necessary and will ensure continued enjoyment of your motorhome.



Your Retailer or Service Centre will carry out your service using the latest techniques and equipment (a list of the items to be inspected, tested and adjusted appears on the Service Vouchers in this handbook), and should provide you with the service document as proof of regular maintenance.

As with motor vehicle service documents, not only will the proof of regular servicing enhance your motorhome resale value, but in the unlikely event of any defect appearing at some later date - a properly serviced and documented motorhome history will enable your Retailer to rapidly assess and where appropriate, carry out the necessary remedial work.

Mains Electrics

It is recommended that you have your mains electrical system inspected by an NICEIC approved contractor every 3 years.

5 Spare Parts

Should you require any replacement parts for your motorhome it is necessary that you contact the Retailer from whom you purchased the motorhome or any Explorer Group approved Retailer and give the following information, which will help in identifying the required component:

- (i) Model and make of motorhome
- (ii) Explorer VIN number
- (iii) Description of required part
- (iv) Photograph, size or diagram of required part

Please Note: All parts must be ordered and supplied through an approved Retailer.

Remedial Work

The Explorer Group together with its suppliers is continually undertaking extensive research into testing,

remedial work procedures and materials such as sealants, adhesives, gaskets and tapes. Therefore, if for any reason your new motorhome is damaged or requires remedial work then only an approved Explorer Group Retailer or Service Centre should undertake such work.

All such work should be undertaken using only approved Explorer Group genuine parts recommended sealant and following Explorer Group procedures. Explorer will also undertake to supply certain specialist repairers with the necessary spare parts. In this case, your selected repairer must contact the Aftersales Department with all enquiries.



MOTORHOME CONSTRUCTION - MAIN COMPONENTS

The following is a brief description of the main components used in your motorhome. More comprehensive descriptions can be found in the equipment manufacturers literature held in the Owner's Information Pack.

Body Shell

Motorhome bodies are constructed from the highest quality materials. The fully insulated floor is constructed from a timber frame with plywood and insulation laminated together for strength. The walls comprise an insulated foam sandwich having pre-coated aluminium exterior surface and vinyl coated plywood interior finish. Wooden framing is positioned within the sandwich to add strength. The very latest 'state of the art' presses are employed to produce the extremely well insulated, robust, yet lightweight sections.

Windows

Windows are all of a double glazed acrylic construction and the door frames are extruded aluminium.

WARNING

On NO account should screw threads longer than 5/8th inch (15mm) be permitted to enter the shell sandwich (from inside). Ensure that all screws are of the self-tapping type. No screw or any other object should be permitted to enter the ceiling of your new motorhome.

AUTOQUEST	
REFRIGERATOR	DOMETIC RM7360
HEATER	TRUMA S3002 PIEZO
WATER HEATER	TRUMA ULTRASTORE
SINK AND DRAINER	SPACE SAVING ARGENT STAINLESS STEEL
OVEN	SPINFLO DUPLEX
HOB	SPINFLO 3 BURNER HOB
TAPS KITCHEN	WHALE MIXER SINGLE BAR TT111
SHOWER EQUIPMENT	WHALE SHOWER MIXER SINGLE BAR TT141
WATER FILTER / PUMP	AUTOFILL SMARTFLO PUMP & STRAINER
12V FLUORECENT	LUMO & CROWN
12V READING DOWN LIGHTS	ZOE EYEBALL HALOGEN
CONTROL PANELS	BCA BLACK
ELECTRICAL FITTINGS	PDL BLACK
TOILET	C402 CASSETTE / THETFORD ROTATABLE WITH ELECTRONIC FLUSH 180 ONLY
CASSETTE BLINDS	SEITZ SERIES 2000

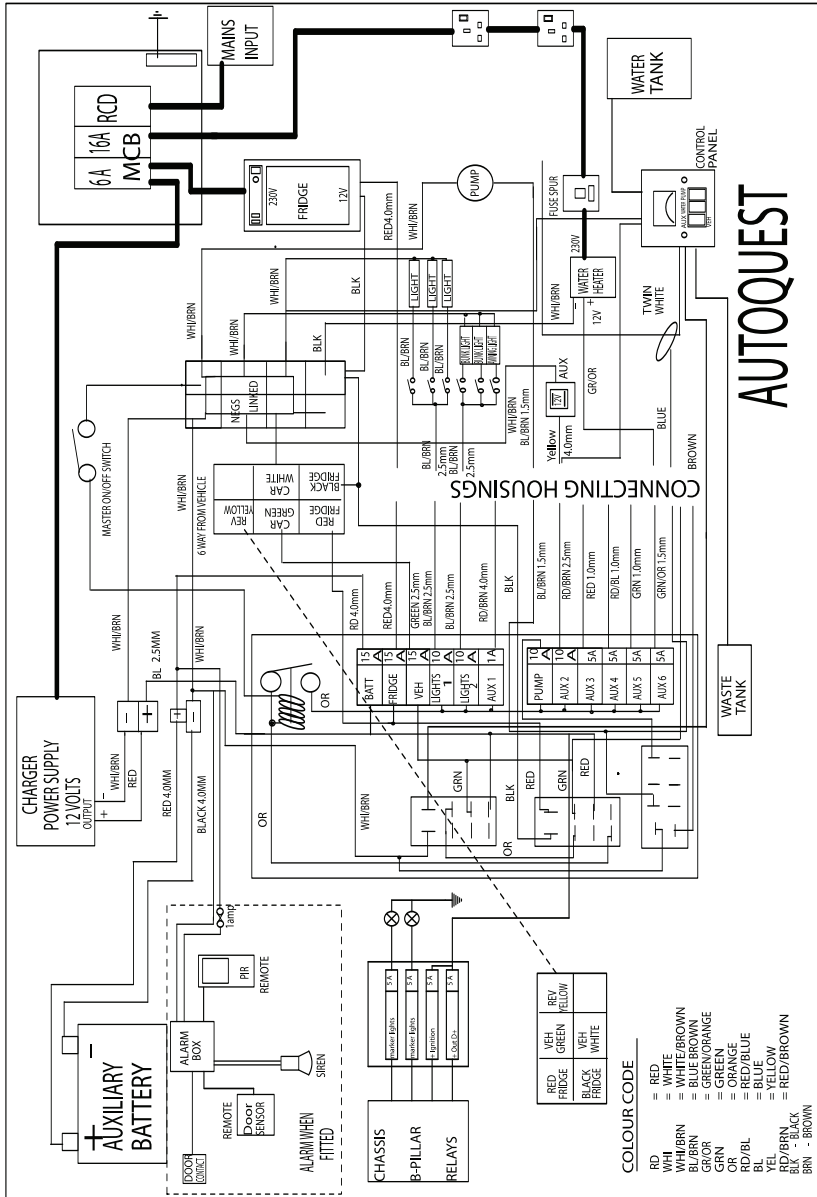

AUTOQUEST

AUTOQUEST 2009 TECHNICAL SPECIFICATIONS

Model	100	115	120	130	140	145	180
Base Vehicle	Project 533 SWB	Project 533 SWB	Project 533 SWB	Project 533 SWB	Project 533 SWB	Project 533 SWB	Project 533 SWB
No. of Berths / Designated Passenger Seats (Ex. Driver)	4/3	2/1	2/1	5/3	2/1	4/3	4/3
Exterior Length mm / feet	5657 / 18'6"	5657 / 18'6"	5785 / 19'0"	6137 / 20'1"	6259 / 20'6"	6259 / 20'6"	7154 / 23'5"
Overall width including wing mirrors mm / feet	2660 / 8'10"	2660 / 8'10"	2660 / 8'10"	2660 / 8'10"	2660 / 8'10"	2660 / 8'10"	2660 / 8'10"
Overall Body Width mm / feet	2380 / 7'8"	2380 / 7'8"	2380 / 7'8"	2380 / 7'8"	2380 / 7'8"	2380 / 7'8"	2380 / 7'8"
Overall Height mm / feet	2960 / 9'7"	2770 / 9'1"	2770 / 9'1"	2960 / 9'7"	2770 / 9'1"	2960 / 9'7"	2960 / 9'7"
Minimum Headroom mm / feet	1985 / 6'4"	1985 / 6'4"	1985 / 6'4"	1985 / 6'4"	1985 / 6'4"	1985 / 6'4"	1985 / 6'4"
Maximum Headroom mm / feet	2380 / 7'8"	1985 / 6'4"	1985 / 6'4"	2380 / 7'8"	1985 / 6'4"	2380 / 7'8"	2380 / 7'8"
Interior Width mm / feet	2074 / 6'9"	2074 / 6'9"	2074 / 6'9"	2074 / 6'9"	2074 / 6'9"	2074 / 6'9"	2074 / 6'9"
Type Size	21670 R15C 108 S	21670 R15C 108 S	21670 R15C 108 S	21670 R15C 108 S	21670 R15C 108 S	21670 R15C 108 S	22675 R15C 112S
Front Tyre Pressure kPa / Psi	410 / 60	410 / 60	410 / 60	410 / 60	410 / 60	410 / 60	410 / 60
Rear Tyre Pressure kPa / Psi	450 / 65	450 / 65	450 / 65	450 / 65	450 / 65	450 / 65	450 / 65
Overhead cab	DOUBLE 2050 x 1370 8'9" x 4'5"	N/A	N/A	DOUBLE 2050 x 1370 8'9" x 4'5"	N/A	DOUBLE 2050 x 1370 8'9" x 4'5"	DOUBLE 2050 x 1370 8'9" x 4'5"
Centre seats	DOUBLE 1870 x 1210 6'2" x 4'0"	DOUBLE 2074 x 1365 6'10" x 4'5"	N/A	DOUBLE 1870 x 1210 6'2" x 4'0"	DOUBLE 2074 x 1365 6'10" x 4'5"	N/A	DOUBLE 1980 x 1200 6'5" x 4'4"
	OR 2 x SINGLE 1850 x 700 6'1" x 2'3"	OR 2 x SINGLE 1850 x 700 6'1" x 2'3"	OR 2 x SINGLE 1850 x 700 6'1" x 2'3"	SINGLE AND OR 1870 x 1210 6'2" x 4'0"	OR 2 x SINGLE 1850 x 700 6'1" x 2'3"	OR 2 x SINGLE 1850 x 700 6'1" x 2'3"	OR 2 x SINGLE 1850 x 700 6'1" x 2'3"
Rear beds	N/A	N/A	DOUBLE 2074 x 1365 6'2" x 4'6"	N/A	DOUBLE 2074 x 1365 6'2" x 4'6"	DOUBLE 2059 x 1370 6'9" x 4'6"	DOUBLE 2059 x 1370 6'9" x 4'6"

Bed Sizes

The Mass in Running Order includes a tolerance for material variances and an allowance for the Driver, a full tank of fuel, 90% of the water tank and the gas bottles.

Maximum User Payload includes Personal Effects, Optional Equipment and the Conventional Load.

Note 1: Please take care to ensure that you have allowed for the masses of all items you intend to carry in the motorcaravan.

Note 2: Warning under no circumstances must the Maximum Technical Permissible Laden Mass of the motorcaravan be exceeded.

Note 3: All data is calculated using metric weights and measurements. The Imperial figures quoted are conversions thereof.

Note 4: Care should be taken when loading your motorhome in order to ensure that you do not exceed either the Front or Rear axle maximum weight.



19-1 GENERAL QUESTIONS

Q: Where Can I Obtain Your Latest Brochure?

A: Our latest brochures are available from Approved Retailers or can be viewed and printed from the **download** section on our website www.explorer-group.co.uk. A request form can also be completed should you wish to receive a printed copy of our latest brochures.

Q: Why Is the Handbook Not Specific To My Model?

A: Many of the components used in the manufacture of our motorhomes are identical throughout our model ranges, so we produce a generic handbook, which covers all models manufactured for that season. If the literature supplied with your motorhome does not answer your question then please contact your Retailer for further assistance.

Q. I Require Technical Or Other Information, Who Can Help Me?

A. The majority of information you require is available through your Explorer Group Retailer.

Q - Can You Tell Me The Second Hand Price Of My Motorhome?

A - As a manufacturer we are not involved in the second hand market. You should contact a Retailer, The Camping and Caravanning Club and/or The Caravan Club. They should be able to give some indication of market value.

Q: Can I Fit A Bicycle Rack/Top Box/Air Conditioning To My motorhome?

A: It may be possible to fit accessories to your motorhome but this will depend upon the internal construction of the roof/walls and whether they can support the weight of the accessory. If it is possible your Retailer will be able to advise you, (or alternatively they will obtain confirmation and a drawing where necessary, from The Explorer Group). Please note that weight of any accessories will reduce your User Payload allowance.

Q: My Interior Lights Are Not Working, What Do I Do?

A: It is possible that all of the 230V mains electrical equipment may not be operated simultaneously. Check fuses, battery connections and power supply (master light switch). Refer to your Retailer for further assistance.

PLEASE NOTE: The internal lights in your motorhome will not operate whilst the motorhome engine is running.

Q: Where Can I Get Spare Parts For My Motorhome?

A: Retailers will be able to source most parts you require. For details of your nearest Explorer Group Retailer please refer to our Find A Retailer section on our website, or call 01207 699 000 for assistance.

Q. How Many Years Will Spare Parts Be Available For My Motorhome?

A. The Explorer Group will endeavour to supply spare parts for a motorhome, for at least 8 years from new.



Q. Why Don't You Stock Parts At The Explorer Group Factory?

- A. Due to the volume of models we produce it is not possible for us to maintain stock levels of every individual component used in our manufacturing process. We do stock commonly requested items, but some items must be made to order

Q. What If The Parts Are No Longer Available?

- A. Where an original part is no longer available, whenever possible we will suggest a suitable alternative if it is available.

Q: Who Can Service My Motorhome?

- A: Your supplying Retailer is obliged to undertake your warranty work. However, any approved Explorer Group Retailer or Service Centre can undertake the work, but this is at their discretion. We will also accept services completed by a NCC approved company, but they will not be able to undertake warranty work if they are not approved by Explorer Group.

Q. I Am Having Trouble Booking My Motorhome in For Its Service, In Line With The Requirements. What Timescale Is Acceptable?

- A. We will allow a delay of 60 days after your service is due, but subsequent annual services should still be undertaken as close as possible to the anniversary of the original date of purchase. Except for 3rd and 5th services that must be on or before the anniversary of the original date of purchase.

Q. I Have A Problem With My motorhome, Who Can Help Me?

- A. We would always recommend that you contact your supplying

Retailer. Your local Explorer Group Retailer or Explorer Group Approved Service Centre may be able to assist. An inspection can then take place and the necessary course of action agreed.

Q. I Am Unhappy With The Service I Have Received From My Retailer/Service Centre, Where Do I Go From Here?

- A. We would recommend that you write to your Retailer/Service Centre, detailing your problems and requirements, requesting a response explaining how they will resolve your complaint. A copy of your letter can also be forwarded to The Explorer Group Customer Services Department, quoting the serial number of your motorhome and the name of the Retailer/Service Centre.

Please be assured that we will assist your Retailer/Service Centre in resolving any problems.



20-1 GLOSSARY

ABS - plastic

Acrylonitrile Butadiene Styrene
Plastic the material used for most of the large plastic components within your motorhome.

Actual Laden Weight

This is the total weight of the motorhome when loaded ready for use by the end user.

Aquaroll

Brand name used generically for a water container that rolls so you don't need to lift it.

Battery Charger

This is required to keep a leisure battery charged. Most motorhomes include a charging facility that operates via the mains hook-up, and also has the ability to recharge from the tow car's alternator while traveling.

Berth(s)

Sleeping place - Refers to the number of people a motorhome can accommodate for sleeping.

Blown Air Heating

A method of heating the living quarters of a motorhome by use of a fan pushing air out through a number of outlets.

Bunk Bed

This is a sleeping place, usually higher up than a conventional bed. Often (but not always) this can be folded or removed to provide additional living space.

Butane

Is a form of Liquefied Petroleum Gas (LPG) that normally comes in blue cylinders. This type of gas is most

commonly used in the UK, although a switch to propane is advised in severely cold weather conditions.

Campingaz

This is the trade name of Butane gas.

Cassette Blind

This is a roller blind that is fitted as part of the window assembly, often along with a flyscreen, thus giving a neat installation.

Cassette Toilet

A form of chemical toilet found in modern motorhomes, where the waste holding tank can be accessed and emptied from outside.

Control Panel

Used as the description for the panel of electrical switches and gauges governing 12V and mains electricity systems.

Dinette

This is a popular style of seating arrangement where two seats or settees face each other across a table.

Earth Leakage Circuit Breaker (ELCB)

ELCB Earth leakage circuit breaker – see residual current device (RCD)

End Kitchen

A common term used to describe floor plans that put the kitchen across the rear, usually adjacent to a motorhome door on one side and washroom on the other.

Essential Habitation Equipment

Those items and fluids required for the safe and proper functioning of the equipment for habitation as defined by the manufacturer of the motorhome. This includes items such as the leisure battery and gas cylinders, plus water contained in the water heater etc.

**Flyscreens**

Mesh fittings for windows doors and roof vents, to keep out insects etc.

Free-Standing Table

This is a table that, because of its leg design, can be used inside or outside.

Full Service Pitch

This is a pitch that has individual provision for fresh water supply and waste water disposal, in addition to mains electricity and in some cases TV aerial connection.

Gas Cylinder

This is a portable, pressurized container for the storage of LPG.

Gas Cylinder Locker

Is the compartment on the motorhome for the storage of gas cylinders.

Gas Drop out Holes

These are not Part of the ventilation. LPG is heavier than air, so holes through the floor below gas-powered appliances allow any leakage of gas to exit the habitation area.

Grey Water

This is the waste water from sink/shower.

Gross Vehicle Weight (GVW)

This is the weight of the vehicle laden to its maximum, as defined by the manufacturer. See also MTPLM.

GRP

Is Glass-reinforced plastic, but more commonly known as glass fibre (not fibre glass, which is a trade name

Handbook

This is an owner's manual, a guide to the workings of your motorhome.

Hardstanding

This is a pitch which has a hard surface made of gravel, asphalt, concrete etc, instead of grass.

Hook-Up

This is a facility on a pitch for connection to mains electricity.

Ingress

Usually meaning water ingress, a possible problem where water seeps in at the joins, usually as a result of worn sealant.

Jack

This is a device for raising the vehicle so that a wheel can be changed.

Kerb Weight

This is the empty weight of a motor vehicle as defined by the manufacturer.

Layout

This is the Interior design and details where furniture units are placed in relation to each other.

Leisure Battery

This supplies the power for the motorhome electrical systems and is sometimes called an auxiliary battery.

Leveling

The process of ensuring that a motorhome is level when sited on a pitch. It is important for comfort and also to ensure the correct functioning of the fridge and water systems.

LPG

Liquid Petroleum Gas, i.e. butane or propane.

L-Shaped

This is a term where the seating area of a motorhome is indeed L-shaped.

**Mains Hook-Up**

This is a site facility where you can plug into a mains electricity supply.

Maximum User Payload

This is the maximum payload available for the user including essential habitational equipment.

MIRO - Mass In Running Order

Weight of the motorhome equipped to the manufacturer's standard specification. Therefore the condition in which it leaves the factory. Note that this does not include any part of the user payload, including the essential habitation equipment.

MTPLM - Maximum Technically Permissible Laden Mass

The technical maximum permissible laden weight of the motorhome, this must not be exceeded.

National Caravan Council

The only trade association representing manufacturers, retailers and suppliers within the caravan and motorhome industry.

Optional Equipment Payload

The payload provided by the Explorer Group for any factory fitted options that may be available.

Owners' Club

This is a group of people who usually own the same brand of caravan or motorhome and enjoy meeting up for rallies.

Payload

The amount you can put into a motorhome. Specifically the difference between the Maximum Technical Permissible Laden Mass (MTPLM) and the Mass In Running Order (MIRO).

PDI

This is an inspection undertaken by the Retailer prior to handover to the customer.

Pitch

A designated area of a caravan site allocated for the use of one outfit. Most sites will be arranged with defined pitches.

Propane

Gas used in colder conditions and is usually supplied in red cylinders.

RCD

This is a residual current device and is part of the electrical system that will 'trip' if there is an electrical fault.

Gas Regulator

Safety device fitted between the gas cylinder and the gas system of a motorhome, which controls the pressure of gas being released from the cylinder.

Road Lights

The external lights used while the vehicle is traveling.

Roof Lights - See Roof Vent.

Roof Vent

Is an opening unit in the ceiling that lets in ventilation and light, these vary in size, but the best ones will have integral blinds and flyscreens and are also called rooflights.

Semi-Rigid Pipe work

Is water pipes made of a semi rigid plastic and are infinitely preferable to cheaper convoluted piping which can act as a trap for germs and smells.

Slats

Sometimes used for beds and can improve ventilation to mattress cushions.

**Space Heater**

This is a Type of heating equipment for the living quarters. Modern units fitted offer gas and mains-operation.

Speed Rating

This is the maximum speed at which a tyre may be used, as marked on its sidewall.

SMMT

Society of Motor Manufacturers and Traders.

Torque Wrench

A form of spanner used to set nuts and bolts to a specified degree of tightness.

It is recommended for adjustment of wheel fixings on motorhomes.

User Payload

The weight of all items carried in the motorhome.

U-Shaped Settee

Usually a reference to seating that literally is 'U' shaped.

Vehicle Kerb weight

The weight of the tow car often indicated in the manufacturers specifications.

VIN - Vehicle Identification Number

This is a unique serial identification number for a vehicle. All Cars and motor motorhomes should carry a VIN. Motorhomes are not obliged to, but most of those sold in recent years in the UK.

Warranty

Are the terms and conditions that spell out your rights with regard to servicing, repair or replacement of parts as provided by the manufacturer.

Wild Camping

Term used for staying overnight away from a site. Illegal in many countries, but permission may be granted by individual landowners.



21-1 ANNUAL HABITATION SERVICE RECORDS

ANNUAL SERVICE RECORD	
MOTORHOME MODEL _____	
VEHICLE IDENTIFICATION NUMBER _____	YEAR _____

1st SERVICE
DATE:
RETAILERS STAMP:
I/We certify that an annual service has been carried out in accordance with the manufacturers' and National Caravan Council recommendations.

2nd SERVICE
DATE:
RETAILERS STAMP:
I/We certify that an annual service has been carried out in accordance with the manufacturers' and National Caravan Council recommendations.

3rd SERVICE
DATE:
RETAILERS STAMP:
I/We certify that an annual service has been carried out in accordance with the manufacturers' and National Caravan Council recommendations.

4th SERVICE
DATE:
RETAILERS STAMP:
I/We certify that an annual service has been carried out in accordance with the manufacturers' and National Caravan Council recommendations.

5th SERVICE
DATE:
RETAILERS STAMP:
I/We certify that an annual service has been carried out in accordance with the manufacturers' and National Caravan Council recommendations.

6th SERVICE
DATE:
RETAILERS STAMP:
I/We certify that an annual service has been carried out in accordance with the manufacturers' and National Caravan Council recommendations.



ANNUAL HABITATION SERVICE RECORDS

<p>7th SERVICE</p> <p>DATE:</p> <p>RETAILERS STAMP:</p> <p>I/We certify that an annual service has been carried out in accordance with the manufacturers' and National Caravan Council recommendations.</p>	<p>8th SERVICE</p> <p>DATE:</p> <p>RETAILERS STAMP:</p> <p>I/We certify that an annual service has been carried out in accordance with the manufacturers' and National Caravan Council recommendations.</p>
<p>9th SERVICE</p> <p>DATE:</p> <p>RETAILERS STAMP:</p> <p>I/We certify that an annual service has been carried out in accordance with the manufacturers' and National Caravan Council recommendations.</p>	<p>10th SERVICE</p> <p>DATE:</p> <p>RETAILERS STAMP:</p> <p>I/We certify that an annual service has been carried out in accordance with the manufacturers' and National Caravan Council recommendations.</p>
<p>11th SERVICE</p> <p>DATE:</p> <p>RETAILERS STAMP:</p> <p>I/We certify that an annual service has been carried out in accordance with the manufacturers' and National Caravan Council recommendations.</p>	<p>12th SERVICE</p> <p>DATE:</p> <p>RETAILERS STAMP:</p> <p>I/We certify that an annual service has been carried out in accordance with the manufacturers' and National Caravan Council recommendations.</p>
<p>13th SERVICE</p> <p>DATE:</p> <p>RETAILERS STAMP:</p> <p>I/We certify that an annual service has been carried out in accordance with the manufacturers' and National Caravan Council recommendations.</p>	<p>14th SERVICE</p> <p>DATE:</p> <p>RETAILERS STAMP:</p> <p>I/We certify that an annual service has been carried out in accordance with the manufacturers' and National Caravan Council recommendations.</p>



MOTORHOME RETAILER SPECIALS

BASE MODEL	RETAILER SPECIAL NAME
Autoquest	Magnum
Autoquest	Suntor
Autoquest	Sunseeker
Autoquest	Liberte

Please Note: All Explorer Group motorhome retailer specials are based on our current base models. For details on the equipment fitted and how to operate them please check under the base model details in the main part of this handbook, for example if you have purchased a Firestorm then the space heater fitted will be operated in the same manner as the space heater fitted in the standard Autoquest.